

SIEMENS

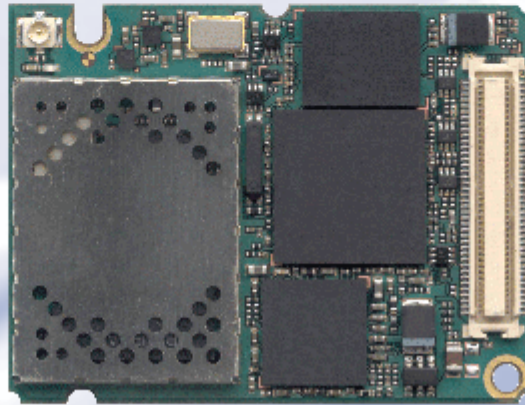

TC65

Siemens Cellular Engine

Version: 00.302
DocId: TC65_ATC_V00.302

AT Command Set

Document Name: **TC65 AT Command Set**

Version: **00.302**

Date: **March 11, 2005**

DocId: **TC65_ATC_V00.302**

Status **Confidential / Draft**

General Notes

Product is deemed accepted by Recipient and is provided without interface to Recipient's products. The Product constitutes pre-release version and code and may be changed substantially before commercial release. The Product is provided on an "as is" basis only and may contain deficiencies or inadequacies. The Product is provided without warranty of any kind, express or implied. To the maximum extent permitted by applicable law, Siemens further disclaims all warranties, including without limitation any implied warranties of merchantability, fitness for a particular purpose and noninfringement of third-party rights. The entire risk arising out of the use or performance of the Product and documentation remains with Recipient. This Product is not intended for use in life support appliances, devices or systems where a malfunction of the product can reasonably be expected to result in personal injury. Applications incorporating the described product must be designed to be in accordance with the technical specifications provided in these guidelines. Failure to comply with any of the required procedures can result in malfunctions or serious discrepancies in results. Furthermore, all safety instructions regarding the use of mobile technical systems, including GSM products, which also apply to cellular phones must be followed. Siemens AG customers using or selling this product for use in any applications do so at their own risk and agree to fully indemnify Siemens for any damages resulting from illegal use or resale. To the maximum extent permitted by applicable law, in no event shall Siemens or its suppliers be liable for any consequential, incidental, direct, indirect, punitive or other damages whatsoever (including, without limitation, damages for loss of business profits, business interruption, loss of business information or data, or other pecuniary loss) arising out the use of or inability to use the Product, even if Siemens has been advised of the possibility of such damages. Subject to change without notice at any time.

Copyright

Transmittal, reproduction, dissemination and/or editing of this document as well as utilization of its contents and communication thereof to others without express authorization are prohibited. Offenders will be held liable for payment of damages. All rights created by patent grant or registration of a utility model or design patent are reserved.

Copyright © Siemens AG 2005

Trademark notice

Bluetooth™ is a registered trademark of Bluetooth SIG Inc.

Contents

1. Introduction.....	13
1.1 Scope of the document	13
1.2 Related documents	14
1.3 Document conventions.....	15
1.3.1 Quick reference table	15
1.3.2 Superscript notation for parameters and values.....	16
1.4 AT Command Syntax	17
1.4.1 Using Parameters.....	17
1.4.2 Combining AT commands on the same command line.....	18
1.5 Supported character sets	19
1.5.1 GSM alphabet tables and UCS2 character values.....	21
1.5.2 UCS2 and GSM data coding and conversion for SMS text mode.....	23
1.5.2.1 Implementing output of SIM data to Terminal (direction TA to TE).....	23
1.5.2.2 Implementing input of Terminal data to SIM (direction TE to TA).....	24
1.6 Serial Interface Flow Control.....	25
1.6.1 Software Flow Control (XON/OFF Handshake)	25
1.6.2 Hardware Flow Control (RTS/CTS Handshake).....	25
1.7 Unsolicited Result Code Presentation.....	26
1.7.1 Communication between Customer Application and TC65.....	26
1.8 Common PCN Handset Specification (CPHS).....	27
1.9 Errors and Messages	28
2. Configuration Commands.....	29
2.1 AT&F Set all current parameters to manufacturer defaults	29
2.2 AT&V Display current configuration	30
2.2.1 AT&V responses	31
2.3 AT&W Stores current configuration to user defined profile	33
2.4 ATQ Set result code presentation mode	34
2.5 ATV Set result code format mode	35
2.5.1 Verbose and numeric result codes.....	35
2.6 ATX Set CONNECT result code format and call monitoring	36
2.7 ATV Set CONNECT result code format	37
2.8 ATZ Set all current parameters to user defined profile.....	38
2.9 AT+CFUN Set phone functionality	39
2.9.1 Wake up the ME from SLEEP mode.....	41
2.10 AT^SMSO Switch off mobile station.....	43
2.11 AT+GCAP Request complete TA capabilities list.....	44
2.12 AT+CMEE Mobile Equipment Error Message Format	45
2.12.1 CME/CMS Error Code Overview.....	46

2.13	AT+CSCS	Select TE character set	50
2.14	AT^SCFG	Extended Configuration Settings	51
2.15	AT^SM20	Set M20 compatibility mode	66
3.	Status Control Commands	67
3.1	AT+CMER	Mobile Equipment Event Reporting	67
3.2	AT+CIND	Indicator control	69
3.3	AT^SIND	Extended Indicator Control	72
3.4	AT+CEER	Extended Error Report.....	79
3.4.1		Cause Location ID for the extended error report.....	80
3.4.2		GSM release cause for L3 Radio Resource (RR)	81
3.4.3		GSM release cause for Mobility Management (MM)	81
3.4.4		GSM release cause for L3 Call Control (CC)	82
3.4.5		GSM Release cause for Supplementary Service Call.....	84
3.4.6		GSM cause for L3 Protocol module or other local cause	85
3.4.7		SIEMENS release cause for GPRS API.....	85
3.4.8		SIEMENS release cause for PPP/IP-Stack.....	85
3.5	ATS18	Extended call release report.....	86
3.6	AT+CPAS	Mobile equipment activity status.....	88
3.7	AT+WS46	Select wireless network	89
4.	Serial Interface Control Commands	90
4.1	AT\Q	Flow control.....	90
4.2	AT&C	Set circuit Data Carrier Detect (DCD) function mode	91
4.3	AT&D	Set circuit Data Terminal Ready (DTR) function mode.....	92
4.4	AT&S	Set circuit Data Set Ready (DSR) function mode	93
4.5	ATE	Enable command echo.....	94
4.6	AT+ICF	Serial Interface Character Framing.....	95
4.7	AT+IFC	Set Flow Control separately for data directions	97
4.8	AT+ILRR	Set TE-TA local rate reporting.....	99
4.9	AT+IPR	Set fixed local rate	101
4.9.1		Autobauding	102
4.10	AT+CMUX	Enter multiplex mode	104
4.10.1		Restrictions on Multiplex mode	105
4.10.2		Second serial interface ASC1	107
4.11	AT^STPB	Transmit Parity Bit (for 7E1 and 7O1 only).....	108
5.	Security Commands	109
5.1	AT+CPIN	PIN Authentication	109
5.1.1		What to do if PIN or password authentication fails?.....	111
5.2	AT+CPIN2	PIN2 Authentication	113
5.3	AT^SPIC	Display PIN counter.....	115
5.4	AT+CLCK	Facility lock	119
5.5	AT^SLCK	Facility lock	124

5.6	AT+CPWD Change Password	125
5.7	AT^SPWD Change Password	129
6.	Identification Commands.....	130
6.1	ATI Display product identification	130
6.2	AT+CGMI Request manufacturer identification.....	131
6.3	AT+GMI Request manufacturer identification	131
6.4	AT+CGMM Request model identification	132
6.5	AT+GMM Request model identification.....	132
6.6	AT+CGMR Request revision identification of software status.....	133
6.7	AT+GMR Request revision identification of software status	133
6.8	AT+CGSN Request International Mobile Equipment Identity (IMEI).....	134
6.9	AT+GSN Request International Mobile Equipment Identity (IMEI)	134
6.10	AT+CIMI Request International Mobile Subscriber Identity (IMSI).....	135
7.	Call related Commands.....	136
7.1	Call Status Information	136
7.2	ATA Answer a call	137
7.3	ATD Mobile originated call to specified number	138
7.4	ATD<<mem><n> Mobile originated call using specific memory and index number	140
7.5	ATD<<n> Mobile originated call from active memory using index number	142
7.6	ATD<<str> Mobile originated call from active memory using corresponding field	143
7.7	ATDI Mobile originated call to ISDN number.....	144
7.8	ATDL Redial last number used	145
7.9	ATH Disconnect existing connection.....	146
7.10	AT+CHUP Hang up call	147
7.11	AT^SHUP Hang up call(s) indicating a specific GSM04.08 release cause	148
7.12	ATS0 Set number of rings before automatically answering a call	150
7.13	ATS6 Set pause before blind dialing	151
7.14	ATS7 Set number of seconds to wait for connection completion	152
7.15	ATS8 Set number of seconds to wait for comma dialing modifier.....	153
7.16	ATS10 Set disconnect delay after indicating the absence of data carrier	154
7.17	ATO Switch from command mode to data mode / PPP online mode.....	155
7.18	+++ Switch from data mode to command mode	156
7.19	AT+CBST Select bearer service type	157
7.20	AT+CRLP Select radio link protocol parameters for originated non-transparent data calls	158
7.21	AT+CLCC List current calls of ME	159
7.22	AT^SLCC Siemens defined command to list current calls of ME.....	161
7.23	AT+CR Service reporting control	167
7.24	AT+CRC Set Cellular Result Codes for incoming call indication	168
7.25	AT+CSNS Single Numbering Scheme	169
7.26	AT^SCNI List Call Number Information	170

7.27	AT^SLCD	Display Last Call Duration	171
7.28	AT^STCD	Display Total Call Duration.....	172
7.29	ATP	Select pulse dialing	173
7.30	ATT	Select tone dialing	173
8.	Network Service Commands	174
8.1	AT+COPN	Read operator names	174
8.2	AT+COPS	Operator Selection	175
8.3	AT^SOPS	Extended Operator Selection	178
8.4	AT+CREG	Network registration	180
8.5	AT+CSQ	Signal quality	183
8.6	AT^SMONC	Cell Monitoring.....	184
8.7	AT^MONI	Monitor idle mode and dedicated mode	186
	8.7.1	AT^MONI responses	187
	8.7.2	Service states.....	188
8.8	AT^MONP	Monitor neighbour cells	189
	8.8.1	AT^MONP responses.....	190
8.9	AT^SMONG	GPRS Monitor	191
	8.9.1	AT^SMONG Cell Info Table	192
8.10	AT^SALS	Alternate Line Service.....	193
8.11	AT^SHOM	Display Homezone	195
8.12	AT^SPLM	Read the PLMN list	196
8.13	AT^SPLR	Read entry from the preferred operators list.....	198
8.14	AT^SPLW	Write an entry to the preferred operators list	199
9.	Supplementary Service Commands	200
9.1	AT+CACM	Accumulated call meter (ACM) reset or query	200
9.2	AT^SACM	Advice of charge and query of ACM and ACMmax	201
9.3	AT+CAMM	Accumulated call meter maximum (ACMmax) set or query.....	203
9.4	AT+CAOC	Advice of Charge information.....	204
9.5	AT+CCUG	Closed User Group	205
9.6	AT+CCFC	Call forwarding number and conditions control	207
9.7	AT+CCWA	Call Waiting	211
9.8	AT+CHLD	Call Hold and Multiparty.....	215
9.9	AT+CLIP	Calling line identification presentation	217
9.10	AT+CLIR	Calling line identification restriction	219
9.11	AT+COLP	Connected Line Identification Presentation	220
9.12	AT+CPUC	Price per unit and currency table.....	222
9.13	AT+CSSN	Supplementary service notifications	224
9.14	AT+CUSD	Supplementary service notifications	226
10.	Internet Service Commands	228
10.1	AT^SICS	Internet Connection Setup Profile.....	229

10.1.1	Example: Default values of a CSD connection profile	232
10.1.2	Example: GPRS connection profile	232
10.2	AT^SISS Internet Service Setup Profile	233
10.3	AT^SISO Internet Service Open	240
10.4	AT^SISC Internet Service Close	242
10.4.1	Effect of parameter <closeMode>	242
10.5	AT^SISR Internet Service Read Data	243
10.6	AT^SISW Internet Service Write Data.....	245
11.	GPRS Commands	247
11.1	AT+CGACT PDP context activate or deactivate	247
11.2	AT+CGANS Manual response to a network request for PDP context activation	249
11.3	AT+CGATT GPRS attach or detach	251
11.4	AT+CGAUTO Automatic response to a network request for PDP context activation	252
11.5	AT+CGDATA Enter data state	254
11.5.1	Automatic deactivation of PDP context during dial-up PPP	255
11.6	AT+CGDCONT Define PDP Context	256
11.7	AT+CGEQMIN 3G Quality of Service Profile (Minimum acceptable).....	258
11.8	AT+CGEQREQ 3G Quality of Service Profile (Requested)	262
11.9	AT+CGPADDR Show PDP address	266
11.10	AT+CGQMIN Quality of Service Profile (Minimum acceptable)	267
11.11	AT+CGQREQ Quality of Service Profile (Requested)	271
11.12	AT+CGREG GPRS network registration status	275
11.13	AT+CGSMS Select service for MO SMS messages	277
11.14	AT^SGACT Query all PDP context activations	278
11.15	AT^SGAUTH Set type of authentication for PPP connection.....	280
11.16	AT^SGCONF Configuration of GPRS related Parameters	281
11.17	ATA Manual response to a network request for PDP context activation.....	282
11.18	ATD*99# Request GPRS service.....	283
11.19	ATD*98# Request GPRS IP service	284
11.20	ATH Manual rejection of a network request for PDP context activation.....	285
11.21	ATS0 Automatic response to a network request for PDP context activation.....	286
11.22	Using GPRS AT commands (Examples).....	287
11.23	Using the GPRS dial command ATD	289
12.	FAX Commands	290
12.1	FAX parameters	290
12.2	AT+FCLASS Fax: Select, read or test service class	291
12.3	AT+FRH Receive Data Using HDLC Framing	292
12.4	AT+FRM Receive Data	293
12.5	AT+FRS Receive Silence.....	294
12.6	AT+FTH Transmit Data Using HDLC Framing.....	295

12.7	AT+FTM Transmit Data.....	296
12.8	AT+FTS Stop Transmission and Wait.....	297
13.	Short Message Service (SMS) Commands.....	298
13.1	SMS parameters	298
13.2	AT+CMGC Send an SMS command.....	303
13.3	AT+CMGD Delete SMS message	304
13.4	AT+CMGF Select SMS message format	305
13.5	AT+CMGL List SMS messages from preferred store.....	306
13.6	AT+CMGR Read SMS messages.....	308
13.7	AT+CMGS Send SMS message	310
13.8	AT+CMGW Write SMS messages to memory	312
13.9	AT+CMSS Send SMS messages from storage	314
13.10	AT+CNMA New SMS message acknowledge to ME/TE, only phase 2+	315
13.11	AT+CNMI New SMS message indications	316
13.12	AT+CPMS Preferred SMS message storage	319
13.13	AT+CSCA SMS service centre address.....	321
13.14	AT+CSCB Select Cell Broadcast Message Indication	322
13.15	AT+CSDH Show SMS text mode parameters.....	323
13.16	AT+CSMP Set SMS text mode parameters	324
13.17	AT+CSMS Select Message Service.....	326
13.18	AT^SCML List Concatenated SMS messages from preferred store	328
13.19	AT^SCMR Read concatenated SMS messages	330
13.20	AT^SCMS Send concatenated SMS messages	332
13.21	AT^SCMW Write concatenated SMS messages to memory	333
13.22	AT^SLMS List SMS Memory Storage	334
13.23	AT^SMGL List SMS messages from preferred store without setting status to REC READ	335
13.24	AT^SMGO Set or query SMS overflow presentation mode or query SMS overflow	336
13.25	AT^SMGR Read SMS message without setting status to REC READ	338
13.26	AT^SSCONF SMS Command Configuration	339
13.27	AT^SSDA Set SMS Display Availability	340
13.28	AT^SSMSS Set Short Message Storage Sequence	341
14.	SIM related Commands.....	342
14.1	AT+CRSM Restricted SIM Access	342
14.2	AT^SXSM Extended SIM Access.....	345
14.3	AT^SCKS Query SIM and Chip Card Holder Status	347
14.4	AT^SSET Indicate SIM data ready.....	349
14.5	AT^SCID Display SIM card identification number	350
14.6	AT+CXXCID Display card ID.....	351
15.	Remote SIM Access (RSA) Commands.....	352
15.1	AT^SRSA Remote SIM Access Activation	354

15.2	AT^SRSM Remote SIM Access Message	359
15.2.1	SAP Request Message Parameter	361
15.2.2	SAP Response Message Parameter.....	362
15.3	Related AT Commands	363
15.3.1	Establishing an RSA connection in a PC environment.....	363
15.3.2	Car cradle scenario (XSAP)	363
15.3.3	Bluetooth scenario (SAP)	364
16.	SIM Application Toolkit (SAT) Commands	365
16.1	AT^SSTA SAT Interface Activation	365
16.2	^SSTN SAT Notification	367
16.3	AT^SSTGI SAT Get Information	368
16.4	AT^SSTR SAT Response	369
17.	Phonebook Commands.....	370
17.1	Sort Order for Phonebooks	370
17.2	AT+CPBR Read from Phonebook.....	371
17.3	AT+CPBS Select phonebook memory storage	374
17.4	AT+CPBW Write into Phonebook	376
17.5	AT^SDLD Delete the 'last number redial' memory	379
17.6	AT^SPBC Find first matching entry in sorted phonebook	380
17.7	AT^SPBD Purge phonebook memory storage.....	381
17.8	AT^SPBG Display phonebook entries in alphabetical order	382
17.9	AT^SPBS Step through the selected phonebook alphabetically	385
18.	Audio Commands	389
18.1	Audio programming model	389
18.2	ATL Set monitor speaker loudness	390
18.3	ATM Set monitor speaker mode.....	390
18.4	AT+CLVL Loudspeaker volume level.....	391
18.5	AT+CMUT Mute control	392
18.6	AT+VTD Tone duration	393
18.7	AT+VTS DTMF and tone generation.....	394
18.8	AT^SAIC Audio Interface Configuration	395
18.9	AT^SNFA Set or query of microphone attenuation	397
18.10	AT^SNFD Set audio parameters to manufacturer default values	399
18.11	AT^SNFI Set microphone path parameters	400
18.12	AT^SNFM Set microphone audio path and power supply.....	401
18.13	AT^SNFO Set audio output (= loudspeaker path) parameter	403
18.14	AT^SNFPT Set progress tones	405
18.15	AT^SNFS Select audio hardware set.....	406
18.16	AT^SNFTTY Signal TTY/CTM audio mode capability.....	409
18.17	AT^SNFV Set loudspeaker volume.....	410

18.18	AT^SNFW	Write audio setting in non-volatile store	411
18.19	AT^SRTC	Ring tone configuration	412
19.	Hardware related Commands		414
19.1	AT+CCLK	Real Time Clock.....	414
19.2	AT+CALA	Set alarm time	415
19.3	AT^SBC	Battery Charge Control.....	418
	19.3.1	Responses returned by read command	420
19.4	AT^SBV	Battery/Supply Voltage	421
19.5	AT^SCTM	Set critical operating temperature presentation mode or query temperature.....	422
19.6	AT^SSYNC	Configure SYNC Pin.....	425
	19.6.1	ME status indicated by status LED patterns.....	426
19.7	AT^SSPI	Serial Protocol Interface	428
	19.7.1	Specifying delay time	430
	19.7.2	Selecting clock mode on SPI.....	431
	19.7.3	Transmitting data over AT interface	432
	19.7.4	Error handling on the I ² C bus	435
	19.7.5	Example: Using I ² C bus.....	436
20.	AT Commands for Handling Java Applications		437
20.1	AT^SJRA	Run Java Application	437
20.2	AT^SJNET	Set Dialup Network Access Parameters.....	438
20.3	AT^SJOTAP	Over The Air Application Provisioning	440
21.	Miscellaneous Commands		442
21.1	A/	Repeat previous command line	442
21.2	ATS3	Set command line termination character.....	443
21.3	ATS4	Set response formatting character	444
21.4	ATS5	Write command line editing character	445
21.5	AT^SFDL	Enter Firmware Download Mode	446
22.	Appendix		447
22.1		Restricted access to SIM data after SIM PIN authentication.....	447
22.2		Star-Hash (*#) Network Commands.....	448
22.3		Available AT Commands and Dependency on SIM PIN	451
22.4		Availability of AT Commands Depending on Operating Mode of ME.....	458
22.5		AT Command Settings storable with AT&W.....	465
22.6		Factory Default Settings Restorable with AT&F	468
22.7		Summary of Unsolicited Result Codes (URC).....	471
22.8		Alphabetical List of AT Commands	474

List of Tables

Table 1.1:	Symbols used to mark the type of parameters	16
Table 1.2:	Symbols used to indicate the correlations with other commands	16
Table 1.3:	Symbols used to mark different types of default values of parameters	16
Table 1.4:	Types of AT commands and responses	17
Table 1.5:	Examples for character definitions depending on alphabet	20
Table 2.1:	Current configuration on ASC0 / MUX channel 1 (example)	31
Table 2.2:	Current configuration on ASC1 and MUX channels 2 and 3 (example)	32
Table 2.3:	Wake-up events in NON-CYCLIC and CYCLIC SLEEP modes	41
Table 2.4:	General "CME ERROR" Codes (GSM 07.07)	46
Table 2.5:	GPRS related "CME ERROR" Codes (GSM 07.07)	47
Table 2.6:	GPRS related "CME ERROR" Codes (SIEMENS)	47
Table 2.7:	SMS related "CMS ERROR" Codes (GSM 07.05)	47
Table 4.1:	Availability of AT Commands on Virtual Channels	105
Table 4.2:	Summary of AT commands with Different Behavior in Multiplex Mode	106
Table 10.1:	Applicability of <code>AT^SICS <conParmTag></code> values	229
Table 19.1:	Modes of the LED and indicated ME functions	426
Table 19.2:	Special characters for ASCII coding	432
Table 19.3:	Structure of a Transfer Frame on the I ² C bus	434
Table 19.4:	Structure of a Transfer Frame for SPI	435
Table 22.1:	Star-Hash (*#) Command Overview	448
Table 22.2:	Abbreviations of Codes and Parameters used in Table 22.1	449
Table 22.3:	Star-Hash Command Response Parameters	450
Table 22.4:	Star-Hash Commands for Supplementary Services	450
Table 22.5:	Available AT Commands and Dependency on SIM PIN	451
Table 22.6:	Availability of AT Commands Depending on Operating Mode of ME	458
Table 22.7:	Settings Stored to User Profile on ASC0 / MUX Channel 1	465
Table 22.8:	Settings Stored to User Profile on ASC1 / MUX Channels 2 and 3	466
Table 22.9:	Factory Default Settings Restorable with AT&F	468
Table 22.10:	Summary of Unsolicited Result Codes (URC)	471
Table 22.11:	Alphabetical List of AT Commands	474

List of Figures

Figure 1.1:	Main character table of GSM 03.38 alphabet	21
Figure 1.2:	Extension character table of GSM 03.38 alphabet	22
Figure 15.1:	Basic Remote SIM Access Usage Scenario	352
Figure 15.2:	SIM usage states of SAP server	353
Figure 15.3:	SIM usage states of SAP client	354
Figure 18.1:	Audio programming model.....	389
Figure 19.1:	Formula to calculate delay.....	430
Figure 19.2:	Delay time on I ² C after Write	430
Figure 19.3:	Delay time on I ² C after Read	430
Figure 19.6:	Clock modes selectable on SPI	431
Figure 19.4:	Delay time on SPI after/before CS enable/disable	431
Figure 19.5:	Delay time between two CS on SPI.....	431
Figure 19.7:	Number of characters in I ² C Transfer and Response Frames	434

1. Introduction

1.1 Scope of the document

This document presents the AT Command Set for the Siemens Cellular Engine
TC65 Version 00.302.

Before using the Cellular Engine or upgrading to a new firmware version please read the latest product information provided in the Release Notes [1].

More information is available at the Siemens Website: <http://www.siemens.com/wm>.

1.2 Related documents

- [1] TC65 Release Notes, Version 00.302
- [2] TC65 Hardware Interface Description, Version 00.302
- [3] TC65 Java User's Guide
- [4] GPRS Startup User's Guide
- [5] Remote-SAT User's Guide
- [6] Multiplexer User's Guide
- [7] Multiplex Driver Developer's Guide for Windows 2000 and Windows XP
- [8] Multiplex Driver Installation Guide for Windows 2000 and Windows XP
- [9] Application Note 02: Audio Interface Design
- [10] Application Note 16: Updating TC65 Firmware
- [11] Application Note 24: Application Developer's Guide
- [12] Application Note 22: Using TTY / CTM equipment with TC65
- [13] SIM Access Profile Interoperability Specification (Revision 0.95c), issued by the Bluetooth Special Interest Group
- [14] TC65 Remote SIM Access User's Guide
- [15] ISO/IEC10646: "Universal Multiple-Octet Coded Character Set (UCS)"; UCS2, 16 bit coding
- [16] ITU-T Recommendation V.24: List of definitions for interchange circuits between data terminal equipment (DTE) and data circuit-terminating equipment (DCE)
- [17] ITU-T Recommendation V.250: Serial asynchronous automatic dialling and control
- [18] 3GPP TS 100 918/EN 300 918 (GSM 02.04): General on supplementary services
- [19] 3GPP TS 100 907 (GSM 02.30): Man-Machine Interface (MMI) of the Mobile Station (MS)
- [20] 3GPP TS 23.038 (GSM 03.38): Alphabets and language specific information
- [21] 3GPP TS 27.005 (GSM 07.05): Use of Data Terminal Equipment - Data Circuit terminating Equipment (DTE - DCE) interface for Short Message Service (SMS) and Cell Broadcast Service (CBS)
- [22] 3GPP TS 27.007 (GSM 07.07): AT command set for User Equipment (UE)
- [23] 3GPP TS 27.060 (GSM 07.60): Mobile Station (MS) supporting Packet Switched Services
- [24] 3GPP TS 51.011 (GSM 11.11): Specification of the Subscriber Identity Module - Mobile Equipment (SIM - ME) interface
- [25] 3GPP TS 11.14 (GSM 11.14): Specification of the SIM Application Toolkit for the Subscriber Identity Module - Mobile Equipment (SIM - ME) interface
- [26] 3GPP TS 22.101 (GSM 22.101): Service principles
- [27] Common PCN Handset Specification (CPHS) v4.2

1.3 Document conventions

Throughout the document, the GSM engines are referred to as ME (Mobile Equipment), MS (Mobile Station), TA (Terminal Adapter), DCE (Data Communication Equipment) or facsimile DCE (FAX modem, FAX board). To control your GSM engine you can simply send AT Commands via its serial interface. The controlling device at the other end of the serial line is referred to as TE (Terminal Equipment), DTE (Data Terminal Equipment) or plainly 'the application' (probably running on an embedded system). All abbreviations and acronyms used throughout this document are based on the GSM specifications. For definitions please refer to TR 100 350 V7.0.0 (1999-08), (GSM 01.04, version 7.0.0 release 1998).

1.3.1 Quick reference table

Each AT command description includes a table similar to the example shown below. The table is intended as a quick reference to indicate the following functions:

- PIN:** Is the AT command PIN protected?
 Yes
 No
 Usage is dependent on conditions specified for the command, or not all command types are PIN protected (for example write command PIN protected, read command not).
- Note:** The table provided in Section [22.3, Available AT Commands and Dependency on SIM PIN](#) uses the same symbols.
- ASC0:** Is the AT command supported on the first physical serial interface ASC0?
 Yes
 No
- ASC1:** Is the AT command supported on the second physical serial interface ASC1?
 Yes
 No
- USB:** Is the AT command supported on the USB interface?
 Yes
 No
- MUXn:** Is the AT command usable on the Multiplexer channels MUX1, MUX2, MUX3?
 Yes
 No
 AT command is usable, but under the restrictions specified in the section related to the command.
- Note:** The columns MUX1, MUX2 and MUX3 are relevant only when the GSM engine operates in Multiplexer mode, that is, when the first physical serial interface is partitioned into 3 virtual channels by using the Multiplexer protocol. Usage is the same on ASC0 and MUX1.
- Is the AT command supported in Airplane mode?
 Yes
 No
- Charge:** Is the AT command supported in Charge-only mode?
 Yes
 No
- Last:** If commands are concatenated, this AT command must be the last one.
 Yes
 No
- Note:** See also Section [1.4, AT Command Syntax](#) for details on concatenated AT commands.

Example:

PIN	ASC0	ASC1	USB	MUX1	MUX2	MUX3	Charge	→	Last
<input type="radio"/>	<input checked="" type="radio"/>	<input checked="" type="radio"/>	<input checked="" type="radio"/>	<input type="radio"/>	<input type="radio"/>	<input type="radio"/>	<input checked="" type="radio"/>	<input type="radio"/>	<input type="radio"/>

1.3.2 Superscript notation for parameters and values

Table 1.1: Symbols used to mark the type of parameters

Parameter type	Meaning
<param> ^(num)	Parameter value must be numeric type
<param> ^(str)	Parameter value must be string type

Table 1.2: Symbols used to indicate the correlations with other commands

Parameter option	Meaning
<param> ^(&W)	Parameter value will be stored with AT&W
<param> ^(&V)	Parameter value will be displayed with AT&V
<param> ^(^SNFW)	Parameter value will be stored with AT^SNFW
<param> ^(+CSCS)	Parameter value has to be (is) coded according to current setting of <chset> (see AT+CSCS for details)

Table 1.3: Symbols used to mark different types of default values of parameters

Value option	Meaning
[x]	Default value: if the parameter is omitted, the value 'x' will be assumed
x ^(&F)	Factory default value, will be restored to 'x' with AT&F
x ^(P)	Powerup default value of a parameter which is not stored at power down
x ^(D)	Delivery default value of a parameter which cannot be restored automatically

1.4 AT Command Syntax

The "AT" or "at" prefix must be set at the beginning of each command line. To terminate a command line enter <CR>. Commands are usually followed by a response that includes "<CR><LF><response><CR><LF>". Throughout this document, only the responses are presented, <CR><LF> are omitted intentionally.

Table 1.4: Types of AT commands and responses

AT command type	Syntax	Function
Test command	AT+CXXX=?	The mobile equipment returns the list of parameters and value ranges set with the corresponding Write command or by internal processes.
Read command	AT+CXXX?	This command returns the currently set value of the parameter or parameters.
Write command	AT+CXXX=<...>	This command sets user-definable parameter values.
Exec(ution) command	AT+CXXX	The execution command reads non-variable parameters determined by internal processes in the GSM engine.

1.4.1 Using Parameters

- Optional parameters are enclosed in square brackets. If optional parameters are omitted, the current settings are used until you change them.
- Optional parameters or subparameters can be omitted unless they are followed by other parameters. If you want to omit a parameter in the middle of a string it must be replaced by a comma. See also example 1.
- A parameter value enclosed in square brackets represents the value that will be used if an optional parameter is omitted. See also example 2.
- When the parameter is a character string, e.g. <text> or <number>, the string must be enclosed in quotation marks, e.g. "Charlie Brown" or "+49030xxxx". Symbols in quotation marks will be recognized as strings.
- All spaces will be ignored when using strings without quotation marks.
- It is possible to omit the leading zeros of strings which represent numbers.
- If an optional parameter of a V.250 command is omitted, its value is assumed to be 0.

Example 1: Omitting parameters in the middle of a string

AT+CCUG?	Query current setting
+CCUG: 1,10,1	
OK	
AT+CCUG=,9	Set only the middle parameter
OK	
AT+CCUG?	Query new setting
+CCUG: 1,9,1	
OK	

Example 2: Using default parameter values for optional parameters

AT+CFUN=5,0	Activate CYCLIC SLEEP mode, don't reset ME
OK	
AT+CFUN?	Query ME mode
+CFUN: 5	
OK	
AT+CFUN=	Set ME back to normal (default parameters: 1,0)
OK	
+CFUN: 1	
OK	

1.4.2 Combining AT commands on the same command line

You may enter several AT commands on the same line. This eliminates the need to type the "AT" or "at" prefix before each command. Instead, it is only needed once at the beginning of the command line. Use a semicolon as command delimiter.

The table below lists the AT commands you cannot enter together with other commands on the same line. Otherwise, the responses may not be in the expected order.

AT command type	Comment
V.250 commands	with FAX commands (Prefix AT+F)
GSM 7.07 commands	with Siemens commands, Prefix AT^S)
GSM 7.05 commands (SMS)	To be used standalone
Commands starting with AT&	To be used standalone
AT+IPR	To be used standalone

Note: When concatenating AT commands please keep in mind that the sequence of processing may be different from the sequential order of command input. Therefore, if the consecutive order of the issued commands and the associated responses is your concern, avoid concatenating commands on the same line.

1.5 Supported character sets

The ME supports two character sets: GSM 03.38 (7 bit, also referred to as GSM alphabet or SMS alphabet) and UCS2 (16 bit, refer to ISO/IEC 10646). See [AT+CSCS](#) for information about selecting the character set. Character tables can be found below.

Explanation of terms

- International Reference Alphabet (IRA)
IRA means that one byte is displayed as two characters in hexadecimal format. For example, the byte 0x36 (decimal 54) is displayed as "36" (two characters). IRA is used here for input 8-bit or 16-bit data via terminal devices using text mode. This means only characters 'A'..'F', 'a'..'f' and '0'..'9' are valid.
- Escape sequences
The escape sequence used within a text coded in the GSM default alphabet (0x1B) must be correctly interpreted by the TE, both for character input and output. To the module, an escape sequence appears like any other byte received or sent.
- Terminal Adapter (TA)
TA is used equivalent to Mobile Equipment (ME) which stands for the GSM module described here. It uses GSM default alphabet as its character set.
- Terminal Equipment (TE)
TE is the device connected to the TA via serial interface. In most cases TE is an ANSI/ASCII terminal that does not fully support the GSM default alphabet, for example MS Hyperterminal.
- TE Character Set
The character set currently used by Terminal Equipment is selected with [AT+CSCS](#).
- Data Coding Scheme (dcs)
DCS is part of a short message and is saved on the SIM. When writing a short message to the SIM in text mode, the dcs stored with [AT+CSMP](#) is used and determines the coded character set.

The behavior when encountering characters, that are not valid characters of the supported alphabets, is undefined.

Due to the constraints described below it is recommended to prefer the USC2 alphabet in any external application.

If the GSM alphabet is selected all characters sent over the serial line (between TE and TA) are in the range from 0 to 127 (7 Bit range). CAUTION: ASCII alphabet (TE) is not GSM alphabet (TA/ME) !

Several problems resulting from the use of GSM alphabet with ASCII terminal equipment:

- "@" character with GSM alphabet value 0 is not printable by an ASCII terminal program (e.g. Microsoft® Hyperterminal®).
- "@" character with GSM alphabet value 0 will terminate any C string! This is because the 0 is defined as C string end tag. Therefore, the GSM Null character may cause problems on application level when using a 'C'-function as "strlen()". This can be avoided if it is represented by an escape sequence as shown in the table below.
By the way, this may be the reason why even network providers often replace "@" with "@=" in their SIM application.
- Other characters of the GSM alphabet are misinterpreted by an ASCII terminal program. For example, GSM "ö" (as in "Börse") is assumed to be "l" in ASCII, thus resulting in "B|rse". This is because both alphabets mean different characters with values hex. 7C or 00 and so on.
- In addition, decimal 17 and 19 which are used as XON/XOFF control characters when software flow control is activated, are interpreted as normal characters in the GSM alphabet.

When you write characters differently coded in ASCII and GSM (e.g. Ä, Ö, Ü), you need to enter escape sequences. Such a character is translated into the corresponding GSM character value and, when output later, the GSM character value can be presented. Any ASCII terminal then will show wrong responses.

Table 1.5: Examples for character definitions depending on alphabet

GSM 03.38 character	GSM character hex. value	Corresponding ASCII character	ASCII Esc sequence	Hex Esc sequence
Ö	5C	\	\5C	5C 35 43
"	22	"	\22	5C 32 32
ò	08	BSP	\08	5C 30 38
@	00	NULL	\00	5C 30 30

CAUTION: Often, the editors of terminal programs do not recognize escape sequences. In this case, an escape sequence will be handled as normal characters. The most common workaround to this problem is to write a script which includes a decimal code instead of an escape sequence. This way you can write, for example, short messages which may contain differently coded characters.

1.5.1 GSM alphabet tables and UCS2 character values

This section provides tables for the GSM 03.38 alphabet supported by the ME. Below any GSM character find the corresponding two byte character value of the UCS2 alphabet.

Main character table of GSM 03.38 alphabet				b7	0	0	0	0	1	1	1	1
				b6	0	0	1	1	0	0	1	1
				b5	0	1	0	1	0	1	0	1
b4	b3	b2	b1		0	1	2	3	4	5	6	7
0	0	0	0	0	@ 0040	Δ 0394	SP 0020	0 0030	i 00A1	P 0050	¿ 00BF	p 0070
0	0	0	1	1	£ 00A3	_ 005F	! 0021	1 0031	A 0041	Q 0051	a 0061	q 0071
0	0	1	0	2	\$ 0024	⊕ 03A6	" 0022	2 0032	B 0042	R 0052	b 0062	r 0072
0	0	1	1	3	¥ 00A5	Γ 0393	# 0023	3 0033	C 0043	S 0053	c 0063	s 0073
0	1	0	0	4	è 00E8	Λ 039B	* 00A4	4 0034	D 0044	T 0054	d 0064	t 0074
0	1	0	1	5	é 00E9	Ω 03A9	% 0025	5 0035	E 0045	U 0055	e 0065	u 0075
0	1	1	0	6	ù 00F9	Π 03A0	& 0026	6 0036	F 0046	V 0056	f 0066	v 0076
0	1	1	1	7	ì 00EC	Ψ 03A8	' 0027	7 0037	G 0047	W 0057	g 0067	w 0077
1	0	0	0	8	ò 00F2	Σ 03A3	(0028	8 0038	H 0048	X 0058	h 0068	x 0078
1	0	0	1	9	ó 00E7	⊙ 0398) 0029	9 0039	I 0049	Y 0059	i 0069	y 0079
1	0	1	0	10 /A	LF [LF]²	⊗ 039E	* 002A	: 003A	J 004A	Z 005A	j 006A	z 007A
1	0	1	1	11 /B	Ø 00D8	⋄ 002B	+ 002B	; 003B	K 004B	Ä 00C4	k 006B	ä 00E4
1	1	0	0	12 /C	ø 00F8	Æ 00C6	, 002C	< 003C	L 004C	O 00D6	l 006C	ö 00F6
1	1	0	1	13 /D	CR [CR]²	æ 00E6	- 002D	= 003D	M 004D	Ñ 00D1	m 006D	ñ 00F1
1	1	1	0	14 /E	Ä 00C5	ß 00DF	. 002E	> 003E	N 004E	Ü 00DC	n 006E	ü 00FC
1	1	1	1	15 /F	ä 00E5	É 00C9	/ 002F	? 003F	O 004F	§ 00A7	o 006F	à 00E0

Figure 1.1: Main character table of GSM 03.38 alphabet

- 1) This code is an escape to the following extension of the 7 bit default alphabet table.
- 2) This code is not a printable character and therefore not defined for the UCS2 alphabet. It shall be treated as the accompanying control character.

Extension character table of GSM 03.38 alphabet				b7	0	0	0	0	1	1	1	1
				b6	0	0	1	1	0	0	1	1
				b5	0	1	0	1	0	1	0	1
b4	b3	b2	b1		0	1	2	3	4	5	6	7
0	0	0	0	0								
									007C			
0	0	0	1	1								
0	0	1	0	2								
0	0	1	1	3								
0	1	0	0	4		^						
						005E						
0	1	0	1	5							€ ²	
											20AC	
0	1	1	0	6								
0	1	1	1	7								
1	0	0	0	8			{					
							007B					
1	0	0	1	9			}					
							007D					
1	0	1	0	10 /A	↵							
					[LF]							
1	0	1	1	11 /B		␣						
1	1	0	0	12 /C				[
								005B				
1	1	0	1	13 /D				~				
								007E				
1	1	1	0	14 /E]				
								005D				
1	1	1	1	15 /F			\					
							005C					

Figure 1.2: Extension character table of GSM 03.38 alphabet

- 1) This code value is reserved for the extension to another extension table. On receipt of this code, a receiving entity shall display a space until another extension table is defined.
- 2) This code represents the EURO currency symbol. The code value is the one used for the character 'e'. Therefore a receiving entity which is incapable of displaying the EURO currency symbol will display the character 'e' instead.
- 3) This code is defined as a Page Break character and may be used for example in compressed CBS messages. Any mobile which does not understand the 7 bit default alphabet table extension mechanism will treat this character as Line Feed.

In the event that an MS receives a code where a symbol is not represented in Figure 1.2, [Extension character table of GSM 03.38 alphabet](#) the MS shall display the character shown in the main default 7 bit alphabet table (see Figure 1.1, [Main character table of GSM 03.38 alphabet](#)).

1.5.2 UCS2 and GSM data coding and conversion for SMS text mode

This section provides basic information on how to handle input and output character conversion for SMS text mode and Remote-SAT if internal (TA) and external (TE) character representation differ, i.e. if the Data Coding Scheme and the TE character use different coding.

1.5.2.1 Implementing output of SIM data to Terminal (direction TA to TE)

Used character set	DCS = 7 bit GSM	DCS = 8 bit Data	DCS = 16 bit UCS2
GSM	Case 1 GSM (1:1)	Case 2 8 bit to IRA (1:2)	Case 3 UCS2 to IRA (2:4)
UCS2	Case 4 GSM to IRA (1:4)	Case 5 8 bit to IRA (1:4)	Case 6 UCS2 to IRA (2:4)

Note: The ratio of SIM bytes to output bytes is given in parentheses.

Case 1

Every GSM character is sent to TE as it is (8-bit value with highest bit set to zero).
Example: 47'H, 53'H, 4D'H → 47'H, 53'H, 4D'H, displayed as "GSM"

Case 2

Every data byte will is sent to TE as 2 IRA characters each representing a halfbyte.
Example: B8'H (184 decimal) → 42'H, 38'H, displayed as "B8"

Case 3

Every 16-bit UCS2 value is sent to TE as 4 IRA characters.
Example: C4xA7'H (50343 decimal) → 43'H, 34'H, 41'H, 37'H, displayed as "C4A7"
Problem: An odd number of bytes leads to an error because there are always two bytes needed for each USC2 character

Case 4

Every GSM character is sent to TE as 4 IRA characters to show UCS2 in text mode.
Example: 41'H ("A") → 30'H, 30'H, 34'H, 31'H, displayed as "0041"

Case 5

Every data byte is sent to TE as IRA representation of UCS2 (similar to case 4).
Example: B2'H → 30'H, 30'H, 42'H, 32'H, displayed as "00B2"

Case 6

Every 16-bit value is sent to TE as IRA representation of it. It is assumed that number of bytes is even.
Example: C3x46'H → 43'H, 33'H, 34'H, 36'H, displayed as "C346"

1.5.2.2 Implementing input of Terminal data to SIM (direction TE to TA)

Used character set	DCS = 7 bit GSM	DCS = 8 bit Data	DCS = 16 bit UCS2
GSM	Case 1 GSM (1:1)	Case 2 IRA to 8 bit (2:1)	Case 3 IRA to 16 bit (4:2)
UCS2	Case 4 UCS2 to GSM (4:1)	Case 5 UCS2 to 8 bit (4:1)	Case 6 UCS2 to 16 bit (4:2)

Note: The ratio between the number of input characters and bytes stored on the SIM is given in parentheses.

Case 1

Every character is sent from TE to TA as GSM character (or ASCII with Hyperterminal).

Character value must be in range from 0 to 127 because of 7-bit GSM alphabet.

To reach maximum SMS text length of 160 characters in 140 bytes space characters will be compressed on SIM.

This must be set using the parameter `<dcsc>` of `AT+CSMP` (add 64).

Example: "ABCDEFGH" typed is sent and stored uncompressed as → 4142434445464748'H (stored compressed as 41E19058341E91'H)

Case 2

Every data byte is sent to TA as 2 IRA characters.

Maximum text length is 280 IRA characters which will be converted into 140 bytes SMS binary user data

Example: "C8" typed is sent as 43'H, 38'H → stored as C8'H

Case 3

Every 16-bit value is sent to TA as 4 IRA characters.

Maximum text length is 280 IRA characters which will be converted into 70 UCS2 characters (16-bit each)

Number of IRA characters must be a multiple of four because always 4 half bytes are needed for a 16-bit value

Example: "D2C8" typed is sent as 44'H, 32'H, 43'H, 38'H → stored as D2C8'H

Case 4

Every GSM character is sent to TA as 4 IRA characters representing one UCS2 character.

Example: To store text "ABC" using UCS2 character set you have to type "004100420043".

This is sent as 30'H,30'H,34'H,31'H, 30'H,30'H,34'H,32'H, 30'H,30'H,34'H,33'H → detected as IRA representation of 3 UCS2 characters, converted to GSM character set and stored as 41'H, 42'H, 43'H.

Maximum input is 640 IRA characters representing 160 UCS2 characters when compression is active. These are converted to 160 GSM 7-bit characters.

Without compression only 140 GSM characters can be stored which are put in as 560 IRA characters.

Values of UCS2 characters must be smaller than 80'H (128 decimal) to be valid GSM characters.

Number of IRA characters must be a multiple of four. Problems:

- "41" → Error, there are four IRA characters (two bytes) needed
- "0000" → Error, not an UCS2 character
- "4142" → Error, value of UCS2 character > 7F'H
- "008B" → Error, value of UCS2 character > 7F'H

This affects the maximum input length of a string)

Case 5

Every UCS2 character is sent as 4 IRA characters and is converted into two 8-bit values. This means that the first two characters have to be '00'.

Example: UCS2 character 009F'H typed as "009F" is sent as 30'H,30'H,39'H,46'H → converted into 8-bit value 9F'H.

Maximum number of UCS2 characters is 140 which are represented by 560 IRA characters. Number of IRA characters must be a multiple of four.

Case 6

Every UCS2 character is sent as 4 IRA characters each and is converted into a 16-bit value again.

Example: UCS2 character 9F3A'H typed as "9F3A" is sent as 39'H,46'H,33'H,41'H → converted into 9F3A'H.

Maximum number of UCS2 characters is 70 which are represented by 280 IRA characters. Number of IRA characters must be a multiple of four.

Invalid UCS2 values must be prevented.

1.6 Serial Interface Flow Control

Flow control is essential to prevent loss of data or avoid errors when, in a data or fax call, the sending device is transferring data faster than the receiving side is ready to accept. When the receiving buffer reaches its capacity, the receiving device should be capable to cause the sending device to pause until it catches up.

There are basically two approaches to regulate data flow: Software flow control and hardware flow control. The High Watermark of the input/output buffer should be set to approximately 60% of the total buffer size. The Low Watermark is recommended to be about 30%. The data flow should be stopped when the capacity rises close to the High Watermark and resumed when it drops below the Low Watermark. The time required to cause stop and go results in a hysteresis between the High and Low Watermarks.

During Multiplex mode ([AT+CMUX](#)) it is recommended to use hardware flow control.

1.6.1 Software Flow Control (XON/OFF Handshake)

Software flow control sends different characters to stop (XOFF, decimal 19) and resume (XON, decimal 17) data flow. The only advantage of software flow control is that three wires would be sufficient on the serial interface.

1.6.2 Hardware Flow Control (RTS/CTS Handshake)

Hardware flow control sets or resets the RTS/CTS wires. This approach is faster and more reliable, and therefore, the better choice. When the High Watermark is reached, CTS is set inactive until the transfer from the buffer has completed. When the Low Watermark is passed, CTS goes active again.

To achieve smooth data flow, ensure that the RTS/CTS lines are present on your application platform. The application should include options to enable RTS/CTS handshake with the GSM engine. This needs to be done with the AT command [AT\Q3](#) - it is not sufficient to set RTS/CTS handshake in the used Terminal program only.

The default setting of the GSM engine is [AT\Q0](#) (no flow control) which must be altered to [AT\Q3](#) (RTS/CTS hardware handshake on). The setting is stored volatile and must be restored each time after the GSM engine was switched off.

[AT\Q](#) has no read command. To verify the current setting of [AT\Q](#), simply check the settings of the active profile with [AT&V](#).

Often, fax programs run an initialization procedure when started up. The initialization commonly includes enabling RTS/CTS hardware handshake, eliminating the need to set [AT\Q3](#) once again. However, before setting up a CSD call, you are advised to check that RTS/CTS handshake is set.

RTS/CTS hardware handshake must also be set if you want to take advantage of the CYCLIC SLEEP modes. For further details refer to [AT+CFUN](#).

1.7 Unsolicited Result Code Presentation

URC stands for Unsolicited Result Code and is a report message issued by the ME without being requested by the TE, i.e. a URC is issued automatically when a certain event occurs. Hence, a URC is not issued as part of the response related to an executed AT command.

Typical events leading to URCs are incoming calls ("RING"), waiting calls, received short messages, changes in temperature, network registration etc.

A list of all URCs can be found in Section [22.7, Summary of Unsolicited Result Codes \(URC\)](#).

To announce a pending URC transmission the ME will do the following:

- Activates its Ring line (logic "1") for one second, i.e. the line changes to physical "Low" level. This allows the TE to enter power saving mode until ME related events request service.
- If the AT command interface is busy a "BREAK" will be sent immediately but the URC will not be issued until the line is free. This may happen if the URC is pending in the following cases:
 - During the processing of an AT command (i.e. the time after the TE echoes back the first character "A" of an AT command just sent by itself until the ME responds with "OK" or "ERROR").
 - During a data call.

Please note that AT command settings may be necessary to enable in-band signaling, e.g. refer to [AT+CMER](#) or [AT+CNMI](#).

It is strongly recommended to use the multiplex mode to map logical communication channels onto the serial line of the TC65, for details refer to [\[6\]](#) and AT command [AT+CMUX](#). Doing so it is possible to use one channel to still process URCs while having a data call active on another.

For most of these messages, the ME needs to be configured whether or not to send an URC. Depending on the AT command, the URC presentation mode can be saved to the user defined profile (see [AT&W](#)), or needs to be activated every time you reboot the ME. Several URCs are not user definable, such as "^SYSSTART", "^SYSSTART <text>", "^SHUTDOWN"

If autobauding is enabled (as factory default mode or set with [AT+IPR=0](#)), URCs generated after restart will be output with 57600 bps until the ME has detected the current bit rate. The URCs "^SYSSTART", "^SYSSTART <text>", however, are not presented at all. For details please refer to Section [4.9.1, Autobauding](#). To avoid problems we recommend to configure a fixed bit rate rather than using autobauding.

1.7.1 Communication between Customer Application and TC65

Leaving hardware flow control unconsidered the Customer Application (TE) is coupled with the TC65 (ME) via a receive and a transmit line.

Since both lines are driven by independent devices collisions may (and will) happen, i.e. while the TE issues an AT command the TC65 starts sending an URC. This will probably lead to the TE's misinterpretation of the URC being part of the AT command's response.

To avoid this conflict the following measures must be taken:

- If an AT command is finished (with "OK" or "ERROR") the TE shall always wait at least 100 milliseconds before sending the next one.
This gives the TC65 the opportunity to transmit pending URCs and get necessary service.
Note that some AT commands may require more delay after "OK" or "ERROR" response, refer to the following command specifications for details.
- The TE shall communicate with the TC65 using activated echo ([ATE1](#)), i.e. the TC65 echoes characters received from the TE.
Hence, when the TE receives the echo of the first character "A" of the AT command just sent by itself it has control both over the receive and the transmit paths.

1.8 Common PCN Handset Specification (CPHS)

The ME provides features to implement a device following the prerequisites of the Common PCN Handset Specification (CPHS) Phase 2.

CPHS Feature	Description/Remarks	AT command
Alternate Line Service	Using two phone numbers with one SIM card.	AT^SALS
Voice Message Waiting Indication	Indicate the receipt of a short message coded as Voice Message Waiting Indicator as defined by the CPHS Phase 2 standard.	AT^SIND , AT+CMER , indicators "vmwait1" and "vmwait2"
Operator (Service provider) name from SIM	Read specific Elementary Files (6F14h, 6F18h) from SIM.	AT+CRSM
Network and Service Provider Lock	Lock/Unlock an ME to specific HPLMN and service provider.	AT+CLCK , (AT+CPIN)
Call Forwarding	Get and set diverted call status. Access specific Elementary File (6F13h) from SIM.	AT+CCFC , AT+CRSM
Customer Service Profile (CSP)	Setting services and their menu entries depending on customer profiles.	AT+CRSM
Information numbers	Hierarchically structured service numbers phonebook on SIM according to CPHS 4.2 (mandatory).	AT+CRSM

1.9 Errors and Messages

The command result codes "+CME ERROR: <err>" and "+CMS ERROR: <err>" indicate errors related to mobile equipment or network functionality.

The format of <err> can be either numeric or verbose and is selectable via [AT+CMEE](#).

A result error code terminates the execution of the command and prevents the execution of all remaining commands that may follow on the same command line. If so, neither "ERROR" nor "OK" result codes are returned for these commands. A 30 seconds timeout will deliver "ERROR" when the input of a command is not complete.

Using the wrong command syntax may result in errors: For example, using the execute command syntax although the command has no execute format, causes "ERROR" to be returned. Likewise, using the write command syntax although the command has no write format causes "+CME ERROR: <err>" to be returned.

See also:

- Section [2.12.1](#), [CME/CMS Error Code Overview](#)
- Section [2.5.1](#), [Verbose and numeric result codes](#)
- Section [3.4](#), [AT+CEER](#)

2. Configuration Commands

The AT Commands described in this chapter allow the external application to determine the TC65's behaviour under various conditions.

2.1 AT&F Set all current parameters to manufacturer defaults

[AT&F](#) sets all current parameters to the manufacturer defined profile. All defined GPRS contexts which are not activated or not online will be undefined (see [AT+CGDCONT](#)).

Syntax

Exec Command																					
AT&F[<value>]																					
Response(s)																					
OK																					
Reference(s)	<table border="1"> <tr> <td>PIN</td> <td>ASC0</td> <td>ASC1</td> <td>USB</td> <td>MUX1</td> <td>MUX2</td> <td>MUX3</td> <td>Charge</td> <td>→</td> <td>Last</td> </tr> <tr> <td><input type="radio"/></td> <td><input checked="" type="radio"/></td> <td><input checked="" type="radio"/></td> <td><input checked="" type="radio"/></td> <td><input checked="" type="radio"/></td> <td><input checked="" type="radio"/></td> <td><input checked="" type="radio"/></td> <td><input checked="" type="radio"/></td> <td><input type="radio"/></td> <td><input checked="" type="radio"/></td> </tr> </table>	PIN	ASC0	ASC1	USB	MUX1	MUX2	MUX3	Charge	→	Last	<input type="radio"/>	<input checked="" type="radio"/>	<input checked="" type="radio"/>	<input checked="" type="radio"/>	<input checked="" type="radio"/>	<input checked="" type="radio"/>	<input checked="" type="radio"/>	<input checked="" type="radio"/>	<input type="radio"/>	<input checked="" type="radio"/>
PIN	ASC0	ASC1	USB	MUX1	MUX2	MUX3	Charge	→	Last												
<input type="radio"/>	<input checked="" type="radio"/>	<input checked="" type="radio"/>	<input checked="" type="radio"/>	<input checked="" type="radio"/>	<input checked="" type="radio"/>	<input checked="" type="radio"/>	<input checked="" type="radio"/>	<input type="radio"/>	<input checked="" type="radio"/>												
V.250																					

Parameter Description

<value> ^(num)	
[0]	Set all TA parameters to manufacturer defaults

Notes

- List of parameters reset to manufacturer default can be found in Section [22.6, Factory Default Settings Restorable with AT&F](#).
- In addition to the default profile, you can store an individual one with [AT&W](#). To alternate between the two profiles enter either [ATZ](#) (loads user profile) or [AT&F](#) (restores factory profile).
- Every ongoing or incoming call will be terminated.

2.2 AT&V Display current configuration

[AT&V](#) returns the current parameter setting. The configuration varies depending on whether or not PIN authentication has been done and whether or not Multiplex mode is enabled (see [AT+CMUX](#)).

Syntax

```
Exec Command
AT&V[<value>]
Response(s)
ACTIVE PROFILE:
... (see Section 2.2.1, AT&V responses)
OK
```

Reference(s)	PIN	ASC0	ASC1	USB	MUX1	MUX2	MUX3	Charge	✈	Last
V.250	<input type="radio"/>	<input checked="" type="radio"/>	<input type="radio"/>	<input checked="" type="radio"/>	<input checked="" type="radio"/>	<input type="radio"/>	<input type="radio"/>	<input type="radio"/>	<input checked="" type="radio"/>	<input type="radio"/>

Parameter Description

<value> ^(num)	
[0]	Profile number

Notes

- The value of \Q (flow control) is also determined by the [AT+IFC](#) command. In case the value set by [AT+IFC](#) cannot be represented by a \Q equivalent, \Q255 will be displayed.
- The parameters of [AT^SMGO](#) can only be displayed after the SMS data from the SIM have been read successfully for the first time. Reading starts after successful SIM authentication has been performed, and may take up to 30 seconds depending on the SIM used. While the read process is in progress, an attempt to read the parameter will result in empty values.
- The parameter of [AT+CSDH](#) will only be displayed in SMS text mode, see [AT+CMGF](#).

2.2.1 AT&V responses

The following tables show four different kinds of responses depending on whether or not the PIN is entered and whether or not the Multiplex mode is enabled (see [AT+CMUX](#)).

Table 2.1: Current configuration on ASC0 / MUX channel 1 (example)

PIN authentication done	No PIN authentication
ACTIVE PROFILE: E1 Q0 V1 X4 &C1 &D2 &S0 \Q0 \V1 S0:000 S3:013 S4:010 S5:008 S6:000 S7:060 S8:000 S10:002 S18:000 +CBST: 7,0,1 +CRLP: 61,61,78,6 +CR: 0 +FCLASS: 0 +CRC: 0 +CMGF: 0 +CSDH: 0 +CNMI: 0,0,0,0,1 +ICF: 3 +IFC: 0,0 +ILRR: 0 +IPR: 57600 +CMEE: 2 ^SMGO: 0,0 +CSMS: 0,1,1,1 ^SACM: 0,"000000","000000" ^SLCC: 0 ^SCKS: 0,1 ^SSET: 0 +CREG: 0,1 +CLIP: 0,2 +CAOC: 0 +COPS: 0,0,"operator" +CGSMS: 3 OK	ACTIVE PROFILE: E1 Q0 V1 X4 &C1 &D2 &S0 \Q0 \V1 S0:000 S3:013 S4:010 S5:008 S6:000 S7:060 S8:000 S10:002 S18:000 +CBST: 7,0,1 +CRLP: 61,61,78,6 +CR: 0 +FCLASS: 0 +ICF: 3 +IFC: 0,0 +ILRR: 0 +IPR: 57600 +CMEE: 2 ^SCKS: 0,1 ^SSET: 0 OK

Table 2.2: Current configuration on ASC1 and MUX channels 2 and 3 (example)

PIN authentication done	No PIN authentication
<p>ACTIVE PROFILE: E1 Q0 V1 X4 &C1 &D0 &S0 \Q0 S0:000 S3:013 S4:010 S5:008 +CR: 0 +CRC: 0 +CMGF: 0 +CSDH: 0 +CNMI: 0,0,0,0,1 +ICF: 3 +IFC: 0,0 +ILRR: 0 +IPR: 57600 +CMEE: 2 ^SMGO: 0,0 +CSMS: 0,1,1,1 ^SACM: 0,"000000","000000" ^SLCC: 0 ^SCKS: 0,1 ^SSET: 0 +CREG: 0,1 +CLIP: 0,2 +CAOC: 0 +COPS: 0,0,"operator" +CGSMS: 3 OK</p>	<p>ACTIVE PROFILE: E1 Q0 V1 X4 &C1 &D0 &S0 \Q0 S0:000 S3:013 S4:010 S5:008 +CR: 0 +ICF: 3 +IFC: 0,0 +ILRR: 0 +IPR: 57600 +CMEE: 2 ^SCKS: 0,1 ^SSET: 0 +CGSMS: 3 OK</p>

2.3 AT&W Stores current configuration to user defined profile

AT&W stores the currently set parameters to a user defined profile in the non-volatile memory.

Syntax

```
Exec Command
AT&W[<value>]
Response(s)
OK
ERROR/+CME ERROR <err>
```

Reference(s)	PIN	ASC0	ASC1	USB	MUX1	MUX2	MUX3	Charge	→	Last
V.250	<input type="radio"/>	<input checked="" type="radio"/>	<input checked="" type="radio"/>	<input checked="" type="radio"/>	<input checked="" type="radio"/>	<input checked="" type="radio"/>	<input checked="" type="radio"/>	<input type="radio"/>	<input checked="" type="radio"/>	<input type="radio"/>

Parameter Description

<value> ^(num)	
[0]	Number of profile

Notes

- The user defined profile will be restored automatically after power-up. Use ATZ to restore user profile and AT&F to restore factory settings. Until the first use of AT&W, ATZ works as AT&F.
- User defined profiles in multiplex mode:
AT&W stores the current setting of each channel to the user profile, no matter on which of the three channels the command is executed. Each channel may have an individual profile.
- A list of parameters stored to the user profile can be found in Section 22.5, AT Command Settings storable with AT&W.

2.4 ATQ Set result code presentation mode

This parameter setting determines whether or not the TA transmits any result code to the TE. Information text transmitted in response is not affected by this setting.

Syntax

Exec Command	
ATQ[<n>]	
Response(s)	
If <n>=0: OK	
If <n>=1: (none)	
Reference(s)	PIN ASC0 ASC1 USB MUX1 MUX2 MUX3 Charge ↗ Last
V.250	<input type="radio"/> <input checked="" type="radio"/> <input checked="" type="radio"/> <input checked="" type="radio"/> <input checked="" type="radio"/> <input checked="" type="radio"/> <input checked="" type="radio"/> <input checked="" type="radio"/> <input type="radio"/> <input checked="" type="radio"/> <input type="radio"/>

Parameter Description

<n> ^{(num)(&W)(&V)}	
[0] ^(&F)	DCE transmits result code
1	Result codes are suppressed and not transmitted

Note

- If Java is running, the firmware will ignore the command. Responses will be invalid or result to "ERROR". See also Java Users Guide, section 3.5.4 Configuring a serial interface using AT commands.

2.5 ATV Set result code format mode

This command determines the contents of header and trailer transmitted with AT command result codes and information responses. Possible responses are described in Section 2.5.1, [Verbose and numeric result codes](#).

Syntax

Exec Command	ATV[<value>]
Response(s)	OK ERROR
Reference(s)	V.250

Parameter Description

<value>^{(num)(&W)(&V)}

[0]	Information response: <text><CR><LF> Short result code format: <numeric code><CR>
1(&F)	Information response: <CR><LF><text><CR><LF> Long result code format: <CR><LF><verbose code><CR>

2.5.1 Verbose and numeric result codes

Verbose format	Numeric format	Meaning
OK	0	Command executed, no errors
CONNECT	1	Link established
RING	2	Ring detected
NO CARRIER	3	Link not established or disconnected
ERROR	4	Invalid command or command line too long
NO DIALTONE	6	No dial tone, dialling impossible, wrong mode
BUSY	7	Remote station busy
CONNECT 2400/RLP	47	Link with 2400 bps and Radio Link Protocol
CONNECT 4800/RLP	48	Link with 4800 bps and Radio Link Protocol
CONNECT 9600/RLP	49	Link with 9600 bps and Radio Link Protocol
CONNECT 14400/RLP	50	Link with 14400 bps and Radio Link Protocol
ALERTING		Alerting at called phone
DIALING		Mobile phone is dialing

2.6 ATX Set CONNECT result code format and call monitoring

ATX determines whether or not the TA detects the presence of dial tone and busy signal and whether or not TA transmits particular result codes.

Syntax

Exec Command																					
ATX[<value>]																					
Response(s)																					
OK ERROR																					
Reference(s)	<table border="1"> <tr> <th>PIN</th> <th>ASC0</th> <th>ASC1</th> <th>USB</th> <th>MUX1</th> <th>MUX2</th> <th>MUX3</th> <th>Charge</th> <th>→</th> <th>Last</th> </tr> <tr> <td>○</td> <td>●</td> <td>●</td> <td>●</td> <td>●</td> <td>●</td> <td>●</td> <td>○</td> <td>●</td> <td>○</td> </tr> </table>	PIN	ASC0	ASC1	USB	MUX1	MUX2	MUX3	Charge	→	Last	○	●	●	●	●	●	●	○	●	○
PIN	ASC0	ASC1	USB	MUX1	MUX2	MUX3	Charge	→	Last												
○	●	●	●	●	●	●	○	●	○												
V.250																					

Parameter Description

<value> ^{(num)(&W)(&V)}	
[0]	CONNECT result code only returned, dial tone and busy detection are both disabled.
1	CONNECT <text> result code only returned, dial tone and busy detection are both disabled.
2	CONNECT <text> result code returned, dial tone detection is enabled, busy detection is disabled.
3	CONNECT <text> result code returned, dial tone detection is disabled, busy detection is enabled.
4(&F)	CONNECT <text> result code returned, dial tone and busy detection are both enabled.

2.7 ATIV Set CONNECT result code format

Syntax

Exec Command																					
AT\V[<value>]																					
Response(s)																					
OK ERROR																					
Reference(s)	<table border="1"> <tr> <td>PIN</td> <td>ASC0</td> <td>ASC1</td> <td>USB</td> <td>MUX1</td> <td>MUX2</td> <td>MUX3</td> <td>Charge</td> <td>→</td> <td>Last</td> </tr> <tr> <td><input type="radio"/></td> <td><input checked="" type="radio"/></td> <td><input type="radio"/></td> <td><input checked="" type="radio"/></td> <td><input checked="" type="radio"/></td> <td><input type="radio"/></td> <td><input type="radio"/></td> <td><input type="radio"/></td> <td><input checked="" type="radio"/></td> <td><input type="radio"/></td> </tr> </table>	PIN	ASC0	ASC1	USB	MUX1	MUX2	MUX3	Charge	→	Last	<input type="radio"/>	<input checked="" type="radio"/>	<input type="radio"/>	<input checked="" type="radio"/>	<input checked="" type="radio"/>	<input type="radio"/>	<input type="radio"/>	<input type="radio"/>	<input checked="" type="radio"/>	<input type="radio"/>
PIN	ASC0	ASC1	USB	MUX1	MUX2	MUX3	Charge	→	Last												
<input type="radio"/>	<input checked="" type="radio"/>	<input type="radio"/>	<input checked="" type="radio"/>	<input checked="" type="radio"/>	<input type="radio"/>	<input type="radio"/>	<input type="radio"/>	<input checked="" type="radio"/>	<input type="radio"/>												
V.250																					

Parameter Description

<value> ^{(num)(&W)(&V)}	
[0]	CONNECT <text> result code returned without RLP trailer
1(&F)	CONNECT <text> result code returned with RLP trailer

Notes

- For circuit switched data calls only.
- Output only if [ATX](#) parameter is set with value > 0.

2.8 ATZ Set all current parameters to user defined profile

[ATZ](#) sets all current parameters to the user profile stored with [AT&W](#). If a connection is in progress, it will be terminated.

All defined GPRS contexts which are not activated or not online will be undefined (see [AT+CGDCONT](#), [AT+CGQREQ](#) and [AT+CGQMIN](#) command).

The user defined profile is stored to the non-volatile memory.

Syntax

Exec Command	
ATZ[<value>]	
Response(s)	
OK	
Reference(s)	PIN ASC0 ASC1 USB MUX1 MUX2 MUX3 Charge → Last
V.250	<input type="radio"/> <input checked="" type="radio"/> <input checked="" type="radio"/> <input checked="" type="radio"/> <input checked="" type="radio"/> <input checked="" type="radio"/> <input checked="" type="radio"/> <input checked="" type="radio"/> <input type="radio"/> <input checked="" type="radio"/> <input type="radio"/>

Parameter Description

<value> ^(num)	
[0]	Reset to user profile

Notes

- First the profile will be set to factory default (see [AT&F](#)). If there is a valid user profile (stored with [AT&W](#)), this profile will be loaded afterwards.
- Any additional commands on the same command line may be ignored. A delay of 300 ms is required before next command is sent, otherwise "OK" response may be corrupted.

2.9 AT+CFUN Set phone functionality

The [AT+CFUN](#) command serves to control the functionality level of the ME. It can be used to reset the ME, to choose one of the SLEEP modes or to return to full functionality.

Intended for power saving, SLEEP mode reduces the functionality of the ME to a minimum and thus minimizes the current consumption. SLEEP mode falls in two categories:

- NON-CYCLIC SLEEP mode `<fun>=0`
- and CYCLIC SLEEP modes, selectable as `<fun>= 7 or 9`.

NON-CYCLIC SLEEP mode permanently blocks the serial interface. The benefit of the CYCLIC SLEEP mode is that the serial interface remains accessible and that, in intermittent wake-up periods, characters can be sent or received without terminating the selected mode. This allows the ME to wake up for the duration of an event and, afterwards, to resume power saving. Please refer to Section 2.9.1, [Wake up the ME from SLEEP mode](#) for a summary of all SLEEP modes and the different ways of waking up the module.

For CYCLIC SLEEP mode both the ME and the application must be configured to use hardware flow control. This is necessary since the CTS signal is set/reset every 0.9-2.7 seconds in order to indicate to the application when the UART is active. The default setting of hardware flow control is `AT\Q0` which must be altered to `AT\Q3`. For use after restart you are advised to add it to the user profile saved with `AT&W`.

If both interfaces ASC0 and ASC1 are connected, hardware flow control must be set in either application.

SLEEP mode management if Java is started: The Java Virtual Machine remains active, but also enters the SLEEP mode. AT commands can be sent from the Java application to the serial interface, no matter which SLEEP mode was selected. This allows you to control the ME even if it is in NON-CYCLIC SLEEP mode

The [AT+CFUN](#) test command returns the values of the supported parameters.

The [AT+CFUN](#) read command returns the current functionality value.

The [AT+CFUN](#) write command can be used to reset the ME, to choose one of the SLEEP modes or to return to full functionality.

Syntax

<p>Test Command</p> <p>AT+CFUN=?</p> <p>Response(s)</p> <p>+CFUN: (list of supported <code><fun>s</code>) , (list of supported <code><rst>s</code>)</p> <p>OK</p>	
<p>Read Command</p> <p>AT+CFUN?</p> <p>Response(s)</p> <p>+CFUN: <code><fun></code></p> <p>OK</p>	
<p>Write Command</p> <p>AT+CFUN=[<code><fun></code> [, <code><rst></code>]]</p> <p>Response(s)</p> <p>OK</p> <p>ERROR</p> <p>+CME ERROR</p>	
<p>Reference(s)</p> <p>GSM 07.07</p>	

Unsolicited Result Codes

URC 1

`^SYSSTART`

Indicates that the ME has been started and is ready to operate. If autobauding is active (`AT+IPR=0`) the URC is not generated.

If the ME is configured to enter the Airplane mode after restart or reset the following URC is received on boot-up: "`^SYSSTART AIRPLANE MODE`". In this mode, only the AT commands listed in Section 22.4, [Availability of AT Commands Depending on Operating Mode of ME](#) can be used. For details please refer to the `AT^SCFG` command, parameter `<mapos>`.

URC 2

`^SYSSTART CHARGE-ONLY MODE`

Indicates that the ME has entered the CHARGE-ONLY mode. This occurs if the charger is connected while the ME is in POWER DOWN mode. If autobauding is active (`AT+IPR=0`) the URC is not generated. In CHARGE-ONLY mode the ME is neither registered to the GSM network nor are the serial interfaces fully accessible. Only the AT commands listed in Section 22.4, [Availability of AT Commands Depending on Operating Mode of ME](#) can be used. For further details on charging refer to the Hardware Interface Description [2].

Parameter Description

<code><fun></code> ^(num)	
0	<p>NON-CYCLIC SLEEP mode: In this mode, the AT interface is not accessible. Consequently, after setting <code><fun>=0</code>, do not send further characters. Otherwise these characters remain in the input buffer and may delay the output of an unsolicited result code. Due to the fact that the serial interface is disabled, this mode cannot be used if a Remote SIM Access (RSA) connection is ongoing (reason: during RSA connections the SIM communication is routed via a serial channel). The first wake-up event stops power saving and takes the ME back to full functionality level <code><fun>=1</code>.</p>
[1] ^(&F)	<p>Full functionality. If the ME is in one of the CYCLIC SLEEP modes you can issue <code>AT+CFUN=1</code> to stop power saving and return to full functionality. If the ME is NON-CYCLIC SLEEP mode, <code><fun>=1</code> can also be sent by the Java application. Keep in mind that, unlike the reset command described below, this action does not restart the ME but only changes the level of functionality. See parameter <code><rst></code> for details on the reset.</p>
7	<p>CYCLIC SLEEP mode: In this mode, the serial interface is shortly enabled while CTS is active. If characters are recognized on the serial interface, the ME stays active for 2 seconds after the last character was sent or received. ME exits SLEEP mode only, if <code>AT+CFUN=1</code> is entered.</p>
9	<p>CYCLIC SLEEP mode: In this mode, the serial interface is shortly enabled while CTS is active. If characters are recognized on the serial interface, the ME stays active after the last character was sent or received for at least the time, which can be configured by <code>AT^SCFG="PowerSaver/Mode9/Timeout",<psm9to></code> (temporary wakeup). In contrast to SLEEP mode 7 assertion of RTS can also be used to temporarily wake up the ME. In this case too, activity time is at least the time set with <code>AT^SCFG="PowerSaver/Mode9/Timeout",<psm9to></code>. RTS can be activated either from ASC0 or ASC1. ME exits SLEEP mode only, if <code>AT+CFUN=1</code> is entered.</p>

`<rst>(num)`

The parameter can only be used if the serial interface is enabled.

Due to the command syntax, you need to enter parameter `<fun>`, followed by `<rst>`, where `<fun>` is only a placeholder and has no effect. See examples below.

- | | |
|-----|---|
| [0] | Placeholder for <code><fun></code> as stated above. |
| 1 | ME resets and restarts to full functionality. After reset and restart, PIN 1 authentication is necessary (<code>AT+CPIN</code>). If autobauding is enabled, it is recommended to wait 3 to 5 seconds before entering the first AT command. For details on autobauding refer to Section 4.9.1, Autobauding . |

Notes

- If both serial interfaces ASC0 and ASC1 are connected, any functionality level set with `AT+CFUN` takes effect on both of them. In Multiplex mode, the CFUN profile is shared by all multiplexer channels.
- If the ME is in Multiplexer mode, it is not recommended to activate SLEEP mode with `AT+CFUN=<fun>`. The best approach to properly control SLEEP mode in this case is to issue the PSC messages described in [6], Section "Power saving control".
- When a circuit-switched call is in progress, `<fun>`=7 or 9 can be activated without terminating the call. However, setting `<fun>`=0 during a circuit-switched call immediately disconnects this call.
- To check whether power saving is on, you can query the status with the read command `AT+CFUN?` only if the module is in full functionality mode or in CYCLIC SLEEP mode. If available, you can also take advantage of the status LED controlled by the SYNC pin (see `AT^SSYNC` and [2]). With `AT^SSYNC` you can select different modes of LED signalization during SLEEP modes (see Section 19.6.1, [ME status indicated by status LED patterns](#) for details). However, the module can wake up temporarily from power saving without leaving its CYCLIC SLEEP mode (without changing `+CFUN "<fun>"`), e.g. for a network scan after a loss of radio coverage, or after receipt of serial data during CYCLIC SLEEP mode. During this "temporary wakeup state" the LED will operate as if the ME was in full functionality mode.
- Recommendation: In NON-CYCLIC SLEEP mode, you can set an RTC alarm to wake up the ME and return to full functionality. This is a useful approach because, in this mode, the AT interface is not accessible.

2.9.1 Wake up the ME from SLEEP mode

A wake-up event is any event that causes the ME to draw more current. Depending on the selected mode, the wake-up event either switches the SLEEP mode off and takes the ME back to full functionality `AT+CFUN=1`, or activates the ME temporarily without terminating the selected SLEEP mode.

Definitions of the state transitions described in Table 2.3:

- Quit: ME exits SLEEP mode.
- Temporary: ME becomes active temporarily for the duration of the event and the mode-specific follow-up time after the last character was sent or received on the serial interface.
- No effect: Event is not relevant in the selected SLEEP mode. The ME does not wake up.

Table 2.3: Wake-up events in NON-CYCLIC and CYCLIC SLEEP modes

Event	Selected mode: <code><fun></code> =0	Selected mode: <code><fun></code> =7 or 9
Ignition line	No effect	No effect
/RTS0 or /RTS1 activation	Quit	Mode 7: No effect (RTS is only used for flow control) Mode 9: Temporary
Unsolicited Result Code (URC)	Quit	Temporary
Incoming voice or data call	Quit	Temporary

Event	Selected mode: <fun>=0	Selected mode: <fun>=7 or 9
Any AT command (incl. outgoing SMS, voice or data call)	From Java: Yes Without Java: Not possible (UART disabled)	Temporary
Incoming SMS (AT+CNMI is set to 0,0 (this is the default setting))	No effect	No effect
Incoming SMS (AT+CNMI is set to 1,1)	Quit	Temporary
GPRS data transfer	From Java: Yes Without Java: Not possible (UART disabled)	Temporary
RTC alarm line	Quit	Temporary
AT+CFUN=1	From Java: Yes Without Java: Not possible (UART disabled)	Quit
Java terminates	Quit	Temporary

2.10 AT^SMSO Switch off mobile station

[AT^SMSO](#) initiates the power-off procedure. High level of the module's PWR_IND pin and the URC "[^SHUTDOWN](#)" notify that the procedure has completed and the module has entered the POWER DOWN mode. Therefore, be sure not to disconnect the operating voltage until PWR_IND is high or until the URC "[^SHUTDOWN](#)" is displayed. Otherwise, you run the risk of losing data. For further details on how to turn off the module see the [\[2\]](#).

Syntax

Test Command	
AT^SMSO=?	
Response(s)	
OK	
Exec Command	
AT^SMSO	
Response(s)	
^SMSO: MS OFF	
OK	
Reference(s)	
SIEMENS	
	PIN ASC0 ASC1 USB MUX1 MUX2 MUX3 Charge → Last
	○ ● ● ● ● ● ● ○ ● ●

Unsolicited Result Code

[^SHUTDOWN](#)

Indicates that the power-off procedure is finished and the module will be switched off in less than 1 second.

Notes

- Do not send any other AT command after [AT^SMSO](#).
- If [AT^SMSO](#) is entered on one of the Multiplexer channels the ME closes the Multiplexer channels, terminates the Multiplexer and deactivates all other functions. Then, the URC "[^SHUTDOWN](#)" will be issued on the physical serial interface (ASC0). The URC will be transmitted at the bit rate last activated on ASC0 for use with the Multiplex driver.
- If both interfaces ASC0 and ASC1 are connected the URC appears on both of them.

2.11 AT+GCAP Request complete TA capabilities list

AT+GCAP returns a list of additional capabilities.

Syntax

Test Command	
AT+GCAP=?	
Response(s)	
OK	
Exec Command	
AT+GCAP	
Response(s)	
+GCAP: <name>	
OK	
Reference(s)	
V.250	
	PIN ASC0 ASC1 USB MUX1 MUX2 MUX3 Charge → Last
	<input type="radio"/> <input checked="" type="radio"/> <input checked="" type="radio"/> <input checked="" type="radio"/> <input checked="" type="radio"/> <input checked="" type="radio"/> <input checked="" type="radio"/> <input checked="" type="radio"/> <input type="radio"/> <input checked="" type="radio"/> <input type="radio"/>

Parameter Description

<name> ^(str)
e.g.: +CGSM,+FCLASS

Note

- +CGSM: The response text shows which GSM commands of the ETSI standard are supported.

2.12 AT+CMEE Mobile Equipment Error Message Format

AT+CMEE controls the format of the error result codes that indicates errors related to TC65 functionality. Format can be selected between plain "ERROR" output, error numbers or verbose "+CME ERROR: <err>" and "+CMS ERROR: <err>" messages.

Possible error result codes are listed in Table 2.4, General "CME ERROR" Codes (GSM 07.07), Table 2.5, GPRS related "CME ERROR" Codes (GSM 07.07) and Table 2.7, SMS related "CMS ERROR" Codes (GSM 07.05).

In multiplex mode (refer AT+CMUX) the setting applies only to the logical channel where selected. The setting on the other channels may differ.

Syntax

<p>Test Command</p> <pre>AT+CMEE=?</pre> <p>Response(s)</p> <pre>+CMEE: (list of supported<errMode>s) OK</pre>	
<p>Read Command</p> <pre>AT+CMEE?</pre> <p>Response(s)</p> <pre>+CMEE: <errMode> OK</pre>	
<p>Write Command</p> <pre>AT+CMEE=<errMode></pre> <p>Response(s)</p> <pre>OK ERROR +CME ERROR: <err></pre>	
<p>Reference(s)</p> <p>GSM 07.07</p>	<p>PIN ASC0 ASC1 USB MUX1 MUX2 MUX3 Charge → Last</p> <p><input type="radio"/> <input checked="" type="radio"/> <input checked="" type="radio"/> <input checked="" type="radio"/> <input checked="" type="radio"/> <input checked="" type="radio"/> <input checked="" type="radio"/> <input type="radio"/> <input checked="" type="radio"/> <input type="radio"/></p>

Parameter Description

<errMode> ^{(num)(&W)(&V)}	
0(&F)(D)	Disable result code, i.e. only "ERROR" will be displayed.
1	Enable error result code with numeric values.
2	Enable error result code with verbose (string) values.

Example

To obtain enhanced error messages it is recommended to choose <errMode>=2.

```
AT+CMEE=2
OK
```

2.12.1 CME/CMS Error Code Overview

Table 2.4: General "CME ERROR" Codes (GSM 07.07)

<err> Code	Text (if AT+CMEE=2)
0	phone failure
1	no connection to phone
2	phone-adaptor link reserved
3	Operation not allowed
4	Operation not supported
5	PH-SIM PIN required
6	PH-FSIM PIN required
7	PH-FSIM PUK required
10	SIM not inserted
11	SIM PIN required
12	SIM PUK required
13	SIM failure
14	SIM busy
15	SIM wrong
16	Incorrect password
17	SIM PIN2 required
18	SIM PUK2 required
20	Memory full
21	invalid index
22	not found
23	Memory failure
24	text string too long
25	invalid characters in text string
26	dial string too long
27	invalid characters in dial string
30	no network service
31	Network timeout
32	Network not allowed emergency calls only
40	Network personalization PIN required
41	Network personalization PUK required
42	Network subset personalization PIN required
43	Network subset personalization PUK required
44	service provider personalization PIN required
45	service provider personalization PUK required
46	Corporate personalization PIN required
47	Corporate personalization PUK required
48	Master Phone Code required
100	unknown
132	service option not supported

<err> Code	Text (if AT+CMEE=2)
133	requested service option not subscribed
134	service option temporarily out of order
256	Operation temporary not allowed
257	call barred
258	phone is busy
259	user abort
260	invalid dial string
261	ss not executed
262	SIM blocked
263	Invalid Block

Table 2.5: GPRS related "CME ERROR" Codes (GSM 07.07)

<err> Code	Text (if AT+CMEE=2)
103	Illegal MS
106	Illegal ME
107	GPRS services not allowed
111	PLMN not allowed
112	Location area not allowed
113	Roaming not allowed in this location area
148	unspecified GPRS error
149	PDP authentication failure
150	invalid mobile class

Table 2.6: GPRS related "CME ERROR" Codes (SIEMENS)

<err> Code	Text (if AT+CMEE=2)
588	GPRS - feature not supported
594	GPRS - invalid address length
595	GPRS - invalid character in address string
596	GPRS - invalid cid value
607	GPRS - missing or unknown APN
625	GPRS - pdp type not supported
630	GPRS - profile (cid) not defined
632	GPRS - QOS not accepted
633	GPRS - QOS validation fail
643	GPRS - unknown PDP address or type
644	GPRS - unknown PDP context
646	GPRS - QOS invalid parameter

Table 2.7: SMS related "CMS ERROR" Codes (GSM 07.05)

<err> Code	Text (if AT+CMEE=2)
1	Unassigned (unallocated) number
8	Operator determined barring
10	Call barred

<err> Code	Text (if AT+CMEE=2)
21	Short message transfer rejected
27	Destination out of service
28	Unidentified subscriber
29	Facility rejected
30	Unknown subscriber
38	Network out of order
41	Temporary failure
42	Congestion
47	Resources unavailable, unspecified
50	Requested facility not subscribed
69	Requested facility not implemented
81	Invalid short message transfer reference value
95	Invalid message, unspecified
96	Invalid mandatory information
97	Message type non-existent or not implemented
98	Message not compatible with short message protocol state
99	Information element non-existent or not implemented
111	Protocol error, unspecified
127	Interworking, unspecified
128	Telematic interworking not supported
129	Short message Type 0 not supported
130	Cannot replace short message
143	Unspecified TP-PID error
144	Data coding scheme (alphabet) not supported
145	Message class not supported
159	Unspecified TP-DCS error
160	Command cannot be actioned
161	Command unsupported
175	Unspecified TP-Command error
176	TPDU not supported
192	SC busy
193	No SC subscription
194	SC system failure
195	Invalid SME address
196	Destination SME barred
197	SM Rejected-Duplicate SM
198	TP-VPF not supported
199	TP-VP not supported
208	D0 SIM SMS storage full
209	No SMS storage capability in SIM
210	Error in MS
211	Memory Capacity Exceeded

<err> Code	Text (if AT+CMEE=2)
212	SIM Application Toolkit Busy
213	SIM data download error
255	Unspecified error cause
300	ME failure
301	SMS service of ME reserved
302	Operation not allowed
303	Operation not supported
304	Invalid PDU mode parameter
305	Invalid text mode parameter
310	SIM not inserted
311	SIM PIN required
312	PH-SIM PIN required
313	SIM failure
314	SIM busy
315	SIM wrong
316	SIM PUK required
317	SIM PIN2 required
318	SIM PUK2 required
320	Memory failure
321	Invalid memory index
322	Memory full
330	SMSC address unknown
331	no network service
332	Network timeout
340	NO +CNMA ACK EXPECTED
500	Unknown error
512	User abort
513	unable to store
514	invalid status
515	invalid character in address string
516	invalid length
517	invalid character in pdu
518	invalid parameter
519	invalid length or character
520	invalid character in text
521	timer expired
522	Operation temporary not allowed

2.13 AT+CSCS Select TE character set

The [AT+CSCS](#) write command informs the TA which character set `<chset>` is used by the TE. This enables the TA to convert character strings correctly between TE and ME character sets. See also Section 1.5, [Supported character sets](#).

Note that when the TA-TE interface is set to 8-bit operation and the used TE alphabet is 7-bit, the highest bit will be set to zero.

Syntax

<p>Test Command</p> <p>AT+CSCS=?</p> <p>Response(s)</p> <p>+CSCS: (list of supported<chset>s)</p> <p>OK</p>	
<p>Read Command</p> <p>AT+CSCS?</p> <p>Response(s)</p> <p>+CSCS: <chset></p> <p>OK</p>	
<p>Write Command</p> <p>AT+CSCS=[<chset>]</p> <p>Response(s)</p> <p>OK</p>	
<p>Reference(s)</p> <p>GSM 07.07, GSM 11.11</p>	<p>PIN ASC0 ASC1 USB MUX1 MUX2 MUX3 Charge → Last</p> <p><input type="radio"/> <input checked="" type="radio"/> <input checked="" type="radio"/> <input checked="" type="radio"/> <input checked="" type="radio"/> <input checked="" type="radio"/> <input checked="" type="radio"/> <input checked="" type="radio"/> <input type="radio"/> <input checked="" type="radio"/> <input type="radio"/></p>

Parameter Description

<code><chset></code> ^(str)	
"GSM" ^(&F)	GSM default alphabet (GSM 03.38 subclause 6.2.1); Note: This setting may cause software flow control problems since the codes used to stop and resume data flow (XOFF = decimal 19, XON = decimal 17) are interpreted as normal characters.
"UCS2"	16-bit universal multiple-octet coded character set (ISO/IEC10646 [32]); UCS2 character strings are converted to hexadecimal numbers from 0000 to FFFF; e.g. "004100620063" equals three 16-bit characters with decimal values 65, 98 and 99, \$(AT R97)\$

2.14 AT^SCFG Extended Configuration Settings

AT^SCFG can be used to query and configure various settings of the TC65.

The AT^SCFG read command returns a list of all supported parameters and their current values.

The AT^SCFG write command queries a configuration parameter (if no value is entered) or sets its value(s).

Input of parameter names is always coded in GSM character set, parameter values are expected to be given as specified via AT+CSCS.

The following error messages may be returned by the AT^SCFG write commands:

- "+CME ERROR: operation temporary not allowed"
Change of parameter value(s) temporarily not allowed.
- "+CME ERROR: invalid index"
Invalid parameter name or value(s).
- "+CME ERROR: invalid characters in text string"
Character set conversion of parameter value(s) failed.
- "+CME ERROR: incorrect password"
A given password was not correct.
- "+CME ERROR: memory failure"
Could not allocate necessary memory or storing a parameter failed.
- "+CME ERROR: operation not allowed"
Change of parameter value(s) not allowed
- "+CME ERROR: unknown"
Other error

Syntax

Test Command

AT^SCFG=?

Response(s)

^SCFG: "AutoExec" , (list of supported <AutoExecCmd>), (list of supported <AutoExecType>), (list of supported <AutoExecIndex>), (list of supported <AutoExecMode>), (max. string length of <AutoExecATC>), (time range of <AutoExecPeriod>)

^SCFG: "GPRS/ATS0/withAttach", (list of supported <gs0aa>s)

^SCFG: "GPRS/AutoAttach", (list of supported <gaa>s)

^SCFG: "GPRS/RingOnIncomingData", (list of supported <groid>s)

^SCFG: "MEopMode/Airplane", (list of supported <map>s)

^SCFG: "MEopMode/Airplane/OnStart", (list of supported <mapos>s)

^SCFG: "PowerSaver/Mode9/Timeout", (list of supported <psm9to>s)

^SCFG: "Radio/Band", (list of supported <rpb>s), (list of supported <rba>s)

^SCFG: "Radio/OutputPowerReduction", (list of supported <ropr>s)

^SCFG: "URC/CallStatus/CI EV", (list of supported <succ>s)

^SCFG: "URC/CallStatus/SLCC", (list of supported <sucs>s)

^SCFG: "URC/Datamode/Ringline", (list of supported <udri>s)

^SCFG: "URC/Ringline", (list of supported <uri>s)

^SCFG: "URC/Ringline/ActiveTime", (list of supported <urat>s)

^SCFG: "Userware/Autostart", (list of supported <ua>s)

^SCFG: "Userware/Autostart/AppName", (list of supported <uaa>length)

^SCFG: "Userware/Autostart/Delay", (list of supported <uad>s)

^SCFG: "Userware/Passwd", (list of supported <upwd>length)

OK

Read Command

AT^SCFG?

Response(s)

```
^SCFG: "AutoExec", <AutoExecCmd>, <AutoExecType>, <AutoExecIndex>, <AutoExecMode>,
<AutoExecATC>[, <AutoExecPeriod>, <AutoExecPeriodTimeLeft>]
^SCFG: "GPRS/ATS0/withAttach", <gs0aa>
^SCFG: "GPRS/AutoAttach", <gaa>
^SCFG: "GPRS/RingOnIncomingData", <groid>
^SCFG: "MEopMode/Airplane", <map>
^SCFG: "MEopMode/Airplane/OnStart", <mapos>
^SCFG: "PowerSaver/Mode9/Timeout", <psm9to>
^SCFG: "Radio/Band", <rbc>, <rba>
^SCFG: "Radio/OutputPowerReduction", <ropr>
^SCFG: "URC/CallStatus/ClEV", <succ>
^SCFG: "URC/CallStatus/SLCC", <sucs>
^SCFG: "URC/Datamode/Ringline", <udri>
^SCFG: "URC/Ringline", <uri>
^SCFG: "URC/Ringline/ActiveTime", <urat>
^SCFG: "Userware/Autostart", <ua>
^SCFG: "Userware/Autostart/AppName", <uaa>
^SCFG: "Userware/Autostart/Delay", <uad>
^SCFG: "Userware/Passwd"
OK
```

Write Command

Automatic AT command execution

```
AT^SCFG="AutoExec", <AutoExecCmd>, <AutoExecType>, <AutoExecIndex>[, <AutoExecMode>,
<AutoExecATC>[, <AutoExecPeriod>]]
```

Response(s)

```
^SCFG: "AutoExec", <AutoExecCmd>, <AutoExecType>, <AutoExecIndex>, <AutoExecMode>,
<AutoExecATC>[, <AutoExecPeriod>, <AutoExecPeriodTimeLeft>]
OK
ERROR
+CME ERROR
```

Write Command

GPRS **ATS0** with automatic attach

```
AT^SCFG="GPRS/ATS0/withAttach"[, <gs0aa>]
```

Response(s)

```
^SCFG: "GPRS/ATS0/withAttach", <gs0aa>
OK
ERROR
+CME ERROR
```

Write Command

Automatic GPRS attach

```
AT^SCFG="GPRS/AutoAttach"[, <gaa>]
```

Response(s)

```
^SCFG: "GPRS/AutoAttach", <gaa>
OK
ERROR
+CME ERROR
```

Write Command

Ring on incoming GPRS IP data packets

```
AT^SCFG="GPRS/RingOnIncomingData"[, <groid>]
```

Response(s)

```
^SCFG: "GPRS/RingOnIncomingData", <groid>
```

OK

ERROR

+CME ERROR

Write Command

Enable/disable Airplane mode during operation

```
AT^SCFG="MEopMode/Airplane"[, <map>]
```

Response(s)

```
^SCFG: "MEopMode/Airplane", <map>
```

OK

ERROR

+CME ERROR

Write Command

Airplane mode upon ME restart

```
AT^SCFG="MEopMode/Airplane/OnStart"[, <mapos>]
```

Response(s)

```
^SCFG: "MEopMode/Airplane/OnStart", <mapos>
```

OK

ERROR

+CME ERROR

Write Command

Query/Set timeout value for power saving mode 9

```
AT^SCFG="PowerSaver/Mode9/Timeout"[, <psm9to>]
```

Response(s)

```
^SCFG: "PowerSaver/Mode9/Timeout", <psm9to>
```

OK

ERROR

+CME ERROR

Write Command

Radio Output Power Reduction

```
AT^SCFG="Radio/OutputPowerReduction"[, <ropr>]
```

Response(s)

```
^SCFG: "Radio/OutputPowerReduction", <ropr>
```

OK

ERROR

+CME ERROR

Write Command

Radio band selection

```
AT^SCFG="Radio/Band"[, <rbp>][, <rba>]
```

Response(s)

```
^SCFG: "Radio/Band", <rbp>, <rba>
```

OK

ERROR

+CME ERROR

Write Command

Configuration of URC "+CIEV: call" Call Status Indication

```
AT^SCFG="URC/CallStatus/CIEV"[, <succ>]
```

Response(s)

```
^SCFG: "URC/CallStatus/CIEV", <succ>
```

OK

ERROR

+CME ERROR

Write Command

Configuration of URC "^SLCC" Call Status Indication

```
AT^SCFG="URC/CallStatus/SLCC"[, <sucs>]
```

Response(s)

```
^SCFG: "URC/CallStatus/SLCC", <sucs>
```

OK

ERROR

+CME ERROR

Write Command

URC indication in datamode via Ring line:

```
AT^SCFG="URC/Datamode/Ringline"[, <udri>]
```

Response(s)

```
^SCFG: "URC/Datamode/Ringline", <udri>
```

OK

ERROR

+CME ERROR

Write Command

URC indication via Ring line:

```
AT^SCFG="URC/Ringline"[, <uri>]
```

Response(s)

```
^SCFG: "URC/Ringline", <uri>
```

OK

ERROR

+CME ERROR

Write Command

Duration of active RING line for URC indications:

```
AT^SCFG="URC/Ringline/ActiveTime"[, <urat>]
```

Response(s)

```
^SCFG: "URC/Ringline/ActiveTime", <urat>
```

OK

ERROR

+CME ERROR

Write Command

Userware autostart status:

```
AT^SCFG="Userware/Autostart"[, <upwd>, <ua>]
```

Response(s)

```
^SCFG: "Userware/Autostart"[, <ua>]
```

OK

ERROR

+CME ERROR

Write Command

Userware autostart application:

```
AT^SCFG="Userware/Autostart/AppName"[, <upwd>, <uaa>]
```

Response(s)

```
^SCFG: "Userware/Autostart/AppName"[, <uaa>]
```

OK

ERROR

+CME ERROR

Write Command

Userware autostart delay:

```
AT^SCFG="Userware/Autostart/Delay"[, <upwd>, <uad>]
```

Response(s)

```
^SCFG: "Userware/Autostart/Delay"[, <uad>]
```

OK

ERROR

+CME ERROR

Write Command

Userware configuration password:

```
AT^SCFG="Userware/Passwd"[, <upwd>old, <upwd>new, <upwd>new]
```

Response(s)

```
^SCFG: "Userware/Passwd"
```

OK

ERROR

+CME ERROR

PIN ASC0 ASC1 USB MUX1 MUX2 MUX3 Charge → Last

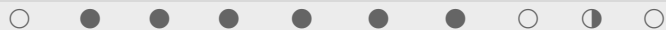

Unsolicited Result Codes

URC 1

```
^SCFG: "AutoExec", <AutoExecState>, <AutoExecType>, <AutoExecIndex>, <AutoExecMode>, <AutoExecATC>
```

If the event specified with <AutoExecType> occurs and the related AT command line is executed this URC is issued.

URC 2

```
^SYSSTART AIRPLANE MODE
```

This URC is issued each time the Airplane mode is activated, no matter whether Airplane mode is set with parameter <map>="on" or <mapos>="on". The URC notifies the user that only the AT commands supported in Airplane mode are accessible. After leaving the Airplane mode the URC "**^SYSSTART**" indicates that the ME has returned to Normal mode and the full set of AT commands is accessible again.

Parameter Description

<AutoExecCmd>^{(str)(+CSCS)}

AutoExec Command

This parameter serves to switch the Autoexec function on or off.

If it is switched off (<AutoExecCmd>=0), parameters following <AutoExecIndex> are ignored and all settings at the given index are restored to their default values.

Value will be saved while switching off the TC65 via AT commands (e.g. AT+CFUN or AT^SMSO) and restored on next power up.

“0“ Disable automatic execution of the AT command(s) specified with <AutoExecATC> at a given <AutoExecIndex>.

“1“ Enable automatic execution of the AT command(s) specified with <AutoExecATC> at a given <AutoExecIndex>. Not allowed for <AutoExecType>=0 (DTR line activation) while multiplex mode is active, refer to AT+CMUX.

<AutoExecType>^{(str)(+CSCS)}

AutoExec Event Type

This parameter selects the kind of event used to automatically launch the AT command(s) specified with <AutoExecATC>.

Value will be saved while switching off the TC65 via AT commands (e.g. AT+CFUN or AT^SMSO) and restored on next power up.

“0“ Autoexec activity is driven by ASC0 DTR line activation (OFF-ON transition).

“1“ Autoexec activity is timer driven. To specify the time span use <AutoExecPeriod>.

<AutoExecIndex>^{(str)(+CSCS)}

AutoExec Command Index

This parameter specifies the command storage index. The following table shows the index ranges supported for each variant of <AutoExecType>.

Value will be saved while switching off the TC65 via AT commands (e.g. AT+CFUN or AT^SMSO) and restored on next power up.

<AutoExecType> value	<AutoExecType> event	Valid Indices
0	Autoexec activity is driven by ASC0 DTR line activation	0
1	Autoexec activity is timer driven.	0-2

<AutoExecMode>^{(str)(+CSCS)}

AutoExec Command Mode

0...255

This parameter specifies details regarding the behavior of the TC65 when the AT command starts to be executed.

Value is interpreted as a bit field, unused bits are reserved for future use (RFU) and shall be set to 0.

When a call is released by an Autoexec activity, no release indication may be issued on the first logical channel. If during a data call the TC65 temporarily enters command mode via +++ no AT command will be executed if <AutoExecMode> specifies 'Ignore ongoing calls'.

Value will be saved while switching off the TC65 via AT commands (e.g. AT+CFUN or AT^SMSO) and restored on next power up.

Bit	Mask _{hex}	Mask _{dec}	Control
D ₀	0x00	0	00: Ignore ongoing calls
D ₁	0x01	1	01: Wait until all calls have ended
	0x02	2	10: Dismiss any ongoing call
	0x03	3	11: RFU
D ₂	0x04	4	0: One shot action
			1: Periodic action (for "AutoExec/Period" only)
D ₃	0x08	8	RFU
D ₄	0x10	16	RFU
D ₅	0x20	32	RFU
D ₆	0x40	64	RFU
D ₇	0x80	128	RFU

`<AutoExecATC>(str)(+CSCS)`

AutoExec AT command String

This parameter specifies the AT command(s) to be launched automatically. Each AT command is executed in the same way as if it were entered online, this means that command concatenation is possible if supported by the given commands. If serial multiplex mode is activated ([AT+CMUX](#)) the first logical channel is used, i.e. CSD calls (data or fax) could be set up. If the TC65 is busy on the serial channel command execution will be delayed until ongoing action is finished.

The first two characters of the automatically launched AT command shall be "at".

Please refer to examples below.

Value will be saved while switching off the TC65 via AT commands (e.g. [AT+CFUN](#) or [AT^SMSO](#)) and restored on next power up.

`<AutoExecPeriod>(str)(+CSCS)`

AutoExec Command Period

Parameter specifies the period after which `<AutoExecATC>` will be executed. Format is "hh:mm:ss", where characters indicate hours, minutes and seconds. This parameter applies to `<AutoExecType>=1` only.

Value will be saved while switching off the TC65 via AT commands (e.g. [AT+CFUN](#) or [AT^SMSO](#)) and restored on next power up.

When using this feature with running java applications, please consider the minimum time for the execution of [AT+CFUN](#) or [AT^SMSO](#) is 15 seconds.

000:00:05...240:00:00

`<AutoExecPeriodTimeLeft>(str)(+CSCS)`

AutoExec Command Period Left

This parameter shows the amount of time left until `<AutoExecATC>` will be executed. Format is "hh:mm:ss", where characters indicate hours, minutes and seconds. This parameter applies to `<AutoExecType>=1` only.

Due to the internal activity and network signaling an execution delay of several seconds may occur for the overall procedure.

000:00:00...240:00:00

`<AutoExecState>(str)(+CSCS)`

AutoExec Command Status

This parameter is part of the Autoexec URC which is presented when a scheduled Autoexec activity is being performed.

"1"

The value 1 indicates that the Autoexec activity specified with `<AutoExec-ATC>` is currently executed.

<gs0aa>^{(str)(+CSCS)}

GPRS ATSO with Attach

This parameter can be used to control the behaviour of [ATSO](#).
Parameter is global for all interfaces, volatile and will not be reset by [AT&F](#).

- | | |
|---------------------|--|
| “on” ^(P) | When the ATSO=<n> (<n> >0) command is received, the MT will attempt to perform a GPRS attach. |
| “off” | When the ATSO=<n> (<n> >0) command is received, the MT will not attempt to perform a GPRS attach. |

<gaa>^{(str)(+CSCS)}

GPRS with AutoAttach

This parameter can be used to control whether the ME will perform a GPRS attach immediately after registering to the network or not. If the setting is changed to "enabled" and the ME is not attached yet, it will not initiate an attach immediately but after the next registration to the network.
Parameter is global for all interfaces, non volatile and will not be reset by [AT&F](#).

- | | |
|---------------------------|------------------------------|
| “disabled” ^(D) | GPRS auto attach is disabled |
| “enabled” | GPRS auto attach is enabled |

<groid>^{(str)(+CSCS)}

Ring on incoming GPRS IP data packets

This parameter can be used to control the behaviour of the RING line for incoming IP packets in GPRS online mode.
Parameter is local for the interface, volatile and will not be reset by [AT&F](#).

- | | |
|----------------------|---|
| “on” | If the ME is in power saving mode 7 or 8 (see AT+CFUN) and hardware flow control is in use (AT\Q3) and the RTS line is inactive and there are incoming IP packets for a GPRS context which is online, then the RING line will be activated once, for a time which is configured by the parameter "URC/Ringline/ActiveTime" (<urat>). The RING line to be used can be configured with the parameter "URC/Ringline" (<uri>). |
| “off” ^(P) | RING line is not activated for incoming IP packets. |

<map>^{(str)(+CSCS)}

MEopMode/Airplane: Enable/disable Airplane mode during operation

The two parameters [<map>](#) and [<mapos>](#) can be used to enable/disable the Airplane mode. Airplane mode shuts down the radio part of the ME (PA and receiver), causes the ME to log off from the GSM/GPRS network and disables all AT commands whose execution requires a radio connection. A list of AT commands supported during Airplane mode can be found in Section [22.4, Availability of AT Commands Depending on Operating Mode of ME](#). The benefit of Airplane mode is that, at locations where no RF emission is allowed (typically airplanes, hospitals etc.), the subscriber can continue using network-independent features rather than powering off the entire device (e.g. a PDA or smartphone).

If the subscriber tries to use an AT command not available in Airplane mode the response "+CME ERROR: Unsupported AT command" is returned.

Parameter [<map>](#) allows entering or leaving the Airplane mode any time during operation, eliminating the need to enter the SIM PIN again. It can be used no matter whether the parameter [<mapos>](#) is "on" or "off".

Parameter [<map>](#) is global for all interfaces, volatile and will not be reset by [AT&F](#).

- | | |
|----------------------|---|
| “on” | Activates Airplane mode and shuts down the radio part of the ME. The URC " ^SYSSTART AIRPLANE MODE " appears. |
| “off” ^(P) | Deactivates Airplane mode, wakes up the radio part of the ME and restores access to network-dependent AT commands. The URC " ^SYSSTART " appears. |

<mapos>^{(str)(+CSCS)}

MEopMode/Airplane: Airplane mode upon ME restart

There are two ways to enter Airplane mode upon restart: One is using [AT^SCFG](#) with <mapos> as described below.

Another approach is configuring the ME to restart into Airplane mode at a scheduled time. In this case, use the [AT+CALA](#) command, set an alarm time and then switch the ME off. When the alarm time is reached the ME wakes up to Airplane mode, no matter whether <mapos> was set "on" or "off".

Parameter <mapos> is global for all interfaces, non volatile and will not be reset by [AT&F](#).

"on" Causes the ME to enter the Airplane mode each time the ME is restarted or reset.

After restart or reset, the URC "[^SYSSTART AIRPLANE MODE](#)" appears and parameter <map> is "on". The SIM PIN can be entered using the [AT+CPIN](#) command. This enables the ME to read data from the SIM and give access to SIM PIN dependent AT commands which are available in Airplane mode, such as phonebook commands or several SMS commands. To notify the user when SIM data are accessible it is recommended to activate the "[^SSIM READY](#)" URC and store its presentation mode to the user profile with [AT&W](#).

To return from Airplane mode to Normal mode set the parameter <map> to "off" as described above. If PIN authentication was already done, the ME will try now to register to the GSM network.

"off"^(P) Airplane mode will not be activated after ME restart or reset.

<psm9to>^{(str)(+CSCS)}

Power saving mode 9 timeout

This parameter can be used to query or configure the wake up time for power saving mode 9 (see [AT+CFUN](#) with parameter <fun>=9). The granularity of the timeout value is 100ms (i.e. a value of 10 equal 1 second). The minimum timeout value that can be applied is 5, but accuracy is only guaranteed for timeout values greater than 20. Parameter is global for the ME, volatile and will not be reset by [AT&F](#).

5...20^(P)...36000

<rba>^{(str)(+CSCS)}

Allowed radio band(s)

The parameters <rba>, <rbb> and <rbc> allow the subscriber to set and query preferences for selecting frequency bands.

Before changing <rba> or <rbb> ensure that no network activity occurs. The write command cannot be executed when making a call, sending or receiving short messages or when the mobile is not registered, but searching for a network. Therefore, to keep track of the module's registration state when changing the band configuration, it is recommended to activate the "[+CREG](#)" first (see Section 8.4, [AT+CREG](#)). For example, the URC "["+CREG": 2](#)" indicates that the ME is in network search mode. In this mode any attempt to change the band parameters will be rejected with ERROR.

Execution of the write command causes the ME to deregister from and re-register to the network, no matter whether the selected <rbb> or <rba> setting really changes. In this case too, it is useful to have the "[+CREG](#)" enabled.

The status of the SIM PIN authentication remains unchanged, eliminating the need to enter the SIM PIN again after the change.

The parameter <rba> determines the maximum range of the bands allowed. The value may be one of the single bands listed below or all valid combinations from the values 1, 2, 4 and 8. Thus, the value range of <rba> is "1".."15". To select or deselect a band calculate the sum of the values of all desired bands and enter the resulting value. For example, for 1800 MHz (2) and 850 MHz (8) please enter the value (10).

Parameter <rba> is global for the ME, non-volatile and will not be reset by [AT&F](#).

"1" GSM 900 MHz

"2" GSM 1800 MHz

"4" GSM 1900 MHz

"8"	GSM 850 MHz
"3"	GSM 900 MHz + GSM 1800 MHz
"5"	GSM 900 MHz + GSM 1900 MHz
"10"	GSM 850 MHz + GSM 1800 MHz
"12"	GSM 850 MHz + GSM 1900 MHz
"15"	all bands

`<rbp>`^{(str)(+CSCS)}

Preferred radio band(s)

The parameter `<rbp>` may be one of the single bands or one of the four dualband combinations listed below. All preferred bands must be contained in the range of allowed bands (see `<rba>`), otherwise the write command will return ERROR. Invalid combinations will neither be accepted, resulting in "+CME ERROR: invalid index". To give priority to a certain single band or band combination and suppress all others simply select the same value both for `<rbp>` and `<rba>`.

`<rbp>` primarily serves to trigger the network search, i.e. it is only used one time for searching and selecting a network. As the currently used band depends on the availability of the allowed networks the value indicated by `<rbc>` may be different from `<rbp>`. Also, next time a network search is necessary, for example after restart, the ME will first try to reselect the network last used, which may be different from the value of `<rbp>` last given. Therefore, the setting of `<rbp>` will not be saved.

The value range of `<rbp>` is "1...15". To select or deselect a band calculate the sum of the values of all desired bands and enter the resulting value. For example, for GSM 1800 MHz (2) and GSM 850 MHz (8) please enter the value (10).

"1"	GSM 900 MHz
"2"	GSM 1800 MHz
"4"	GSM 1900 MHz
"8"	GSM 850 MHz
"3"	GSM 900 MHz + GSM 1800 MHz
"5"	GSM 900 MHz + GSM 1900 MHz
"10"	GSM 850 MHz + GSM 1800 MHz
"12"	GSM 850 MHz + GSM 1900 MHz

`<rbc>`^{(str)(+CSCS)}

Currently selected radio band(s)

The band(s) indicated with `<rbc>` are all allowed bands found at a location area. This means, if prompted to select a network the ME will search for these networks only. The value can be either a single band or a dualband combination.

`<rbc>` is only a response parameter returned either after sending the read command `AT^SCFG?` or writing `AT^SCFG="Radio/Band"`.

In addition to `<rbc>` and to allow the subscriber to be notified whenever the selected band changes it is recommended to activate the "+CIEV" (see Section 3.3, `AT^SIND`).

"1"	GSM 900 MHz
"2"	GSM 1800 MHz
"4"	GSM 1900 MHz
"8"	GSM 850 MHz
"3"	GSM 900 MHz + GSM 1800 MHz
"5"	GSM 900 MHz + GSM 1900 MHz
"10"	GSM 850 MHz + GSM 1800 MHz
"12"	GSM 850 MHz + GSM 1900 MHz

<ropr>^{(str)(+CSCS)}

Radio Output Power Reduction

According to Release 99 (V5), output power reduction for multiple TX slots is a feature recommended to be integrated in every mobile station. For compliance with this recommendation all TC65 modules are capable of a nominal reduction ranging from 3.0dB for 2TX, 4.8dB for 3Tx to 6dB for 4TX. As this feature is not mandatory for mobile stations, it is possible to lower or even deactivate the maximum output power reduction, particularly when the application is designed such that high output power and heat dissipation are of no great concern. Therefore, you can use [AT^SCFG](#) to specify the following output power reduction profiles, allowing you to increase or maximize the module's performance.

Parameter is global for all interfaces, non volatile and will not be reset by [AT&F](#).

"0"	Full Power at GMSK (0dB reduction for 1TX, 2TX, 3TX and 4TX)
"1"	Medium Reduction at GMSK (0dB for 1TX and 2TX, 1.8dB for 3TX and 3dB reduction 4TX)
"2"	Medium Reduction at GMSK (1TX 0dB, 2TX 3dB, 3TX 4.8dB and 4TX 6dB reduction)
"3" ^(P)	Maximal Reduction at GMSK (1TX 0dB, 2TX 3dB, 3TX 4.8dB and 4TX 6dB reduction)

<succ>^{(str)(+CSCS)}

CIEV Call Status Indication

This parameter can be used to control the behaviour of URC "+CIEV: call". See also [AT+CIND](#), [AT+CMER](#) and Section 7.1, [Call Status Information](#).

Parameter is global for all interfaces and will not be reset by [AT&F](#).

"restricted" ^(P)	URC "+CIEV: call" will be issued only when a Call Status transition ends in state "active" or "unknown" (see Section 7.1, Call Status Information) for a call in the list of active calls.
"verbose"	URC "+CIEV: call" will be issued when any state transition (including transitions beginning or ending in state "unknown") occurs in the list of active calls, or when a traffic channel is established.

<sucs>^{(str)(+CSCS)}

SLCC Call Status Indication

This parameter can be used to control the behaviour of URC "^SLCC". See also [AT^SLCC](#) and Section 7.1, [Call Status Information](#).

Parameter is global for all interfaces and will not be reset by [AT&F](#).

"restricted"	URC "^SLCC" will be issued only when a Call Status transition ends in state "active" or "unknown" (see Section 7.1, Call Status Information) for a call in the list of active calls
"verbose" ^(P)	URC "^SLCC" will be issued when any state transition (including transitions beginning or ending in state "unknown") occurs in the list of active calls, or when a traffic channel is established.

<uri>^{(str)(+CSCS)}

URC RING line

This parameter can be used to control the behaviour of the RING line to indicate URCs (both for idle interfaces and, if configured by the parameter "URC/Datamode/Ringline", if link is reserved) and, if configured, the indicator for incoming IP packets (see parameter "GPRS/RingOnIncomingData" (<groid>)).

Parameter is local for the interface, volatile and will not be reset by [AT&F](#).

"off"	URC is not indicated by RING.
-------	-------------------------------

"local" ^(P)	URC will be indicated by an activated RING line of the interface on which the URC appears
"asc0"	URC is indicated by an activated RING0 line.

<udri>^{(str)(+CSCS)}

URC Datamode RING line

This parameter specifies whether RING or BREAK is used for the signaling of URCs when the TA-TE link is reserved (e.g. during circuit-switched data calls, fax connections, in GPRS data mode or during the execution of an AT command).

Parameter is global for all interfaces, volatile and will not be reset by [AT&F](#).

"off" ^(P)	URC will be indicated by BREAK
"on"	URC is indicated by an active RING line for a time which is configured by the parameter "URC/Ringline/ActiveTime" (<urat>). The RING line which will be used, can be configured by the parameter "URC/Ringline" (<uri>).

<urat>^{(str)(+CSCS)}

URC RING line Active Time

This parameter can be used to control how long the RING line is activated to indicate URCs (both for idle interfaces and, if configured by the parameter "URC/Datamode/Ringline" (<udri>), if link is reserved) and, if configured by the parameter "GPRS/RingOnIncomingData", to indicate incoming GPRS IP data packets (<groid>).

Parameter is global for all interfaces, volatile and will not be reset by [AT&F](#).

"0"	RING line will be activated for a time between 4.6 and 9.2 ms.
"1"	RING line will be activated for about 100ms.
"2" ^(P)	RING line will be activated for about 1s.

<ua>^{(str)(+CSCS)}

Userware Autostart

Specifies if the userware is started automatically on power on.

If autostart is enabled, it is no longer possible to use the multiplexer (see [AT+CMUX](#)).

Parameter is global, stored non-volatile in ME and not reset by [AT&F](#).

"0" ^(D)	Userware autostart disabled
"1"	Userware autostart enabled

<uaa>^{(str)(+CSCS)}

Userware Autostart AppName

Specifies the absolute path of the userware (the jar/jad file containing the desired application) to be started automatically on power on. The local flash file system is identified by: "A:", directory separator is "/" (002Fh). The underline character "_" (005Fh) will not be supported.

Parameter is global, stored non-volatile in ME and not reset by [AT&F](#).

<uad>^{(str)(+CSCS)}

Userware Autostart Delay

Specifies the delay time (in 100ms) when the userware is started automatically after power on.

Parameter is global, stored non-volatile in ME and not reset by [AT&F](#).

0^(D)...10000

<upwd>^{(str)(+CSCS)}

Userware Password

Password is required to change values of userware parameters. It is allowed to have an empty password (this is the value on delivery of the module). Parameter must be enclosed in quotation marks, regardless whether the password is given or empty. See example below.

Parameter is global, stored non-volatile in ME and not reset by AT&F.

CAUTION: Be careful not to lose the password. There is no way to reset or recover a forgotten password or to obtain a new password from the manufacturer.

“(D)

Notes

- Any changes to parameters of the Autoexec function will be saved and restored on next power-up only when the ME is switched off via AT commands (e.g. AT+CFUN or AT^SMSO).
- Please keep in mind, that each time the ME is restarted the timers of all autoexec actions configured with <AutoExecType>=1 and <AutoExecPeriod> will be reinitialized and restarted. As a result, an autoexec action configured at a time later then a scheduled automatic restart would never be executed.
- Be careful using <AutoExecType>=1 with small period values and shutdown or reset AT commands, since only little time remains to change these settings again after TC65 restart.
- If <AutoExecATC> uses AT commands containing secret data, this information may be retrieved with AT^SCFG?. For instance, this applies if using AT+CPIN.
- Parameters "GPRS/ATSO/withAttach" (<gs0aa>) and "GPRS/RingOnIncomingData" (<groid>) are available only for modules supporting GPRS.
- The Userware/Autostart mechanism takes effect also in ALARM-MODE and CHARGE-ONLY-MODE.
- If the Java application starts, all current calls will be terminated.

Examples

EXAMPLE 1

Enable sending of a short message (SMS) on next DTR activation (OFF-ON transition). Sent SMS is assumed to be stored at first location of storage selected with AT+CPMS and AT^SSMSS, i.e. SMS may be sent either from SIM or ME storage.

Also refer to AT+CMSS and AT+CMGW. Since SMS transmission and ongoing calls are possible at the same time there is no need to wait until all calls have ended (<AutoExecMode>=0).

AT+CMGF=1	Enable SMS text mode.
OK	
AT+CNMI=1,1	Enable "+CMTI:" URC to be indicated when a short message is received.
OK	
AT+CMGD=1	Delete first SMS location.
OK	
AT+CMGW="01522400045",145	Start writing a short message.
>Test-SMS to be sent from storage!	Enter the text of the message. Finish with CTRL-Z.
+CMGW: 1	Confirms that message is stored to first location.
OK	
AT^SCFG="AutoExec",1,0,0,0,"AT+CMSS=1"	Enable execution on next DTR activation.
^SCFG: "AutoExec","1","0","0","0","at+cmss=1"	
^SCFG: "AutoExec","0","1","0","0","","","000:00:00","000:00:00"	
^SCFG: "AutoExec","0","1","1","0","","","000:00:00","000:00:00"	
^SCFG: "AutoExec","0","1","2","0","","","000:00:00","000:00:00"	
OK	

If a DTR activation has occurred the ME issues the URC "^SCFG: " followed by the response of the executed command; the message reference in this case:

```
^SCFG:"AutoExec",0,0,1,0,"AT+CMSS=1"
OK
+CMSS: 16
```

Confirms that AT+CMSS=1 has been issued.

EXAMPLE 2

Configure TC65 to perform a reset every 10 hours. The execution of the reset command shall be deferred until after any calls have ended.
For details regarding software controlled power down refer to [AT+CFUN](#) and [AT^SMSO](#).

```
AT^SCFG="AutoExec",1,1,2,5,"AT+CFUN=0,1","010:00:00"
...
OK
```

After ten hours:

```
^SCFG:"AutoExec",1,1,2,5,"AT+CFUN=0,1"
OK
SYSSTART
```

Confirms that AT+CFUN=0,1 has been issued.
TC65 has restarted. Remember that the "**^SYSSTART**" URC will not appear if autobauding is enabled.

EXAMPLE 3

Switch off the ME after three minutes without restarting it.
For details regarding software controlled power down refer to [AT+CFUN](#) and [AT^SMSO](#).

```
AT^SCFG="AutoExec",1,1,2,0,"AT^SMSO","000:03:00"
...
OK
```

After three minutes:

```
^SCFG:"AutoExec",0,1,2,0,"AT^SMSO"
^SMSO: MS OFF
^SHUTDOWN
```

Indicates that AT^SMSO was successfully executed.
The ME enters the POWER DOWN mode.

EXAMPLE 4

Deactivate a timer-driven Autoexec function configured at [<AutoExecIndex>](#) 2 (such as the periodic automatic reset or the automatic switch-off functions configured in the preceding examples):

```
AT^SCFG="AutoExec",0,1,2
...
OK
```

EXAMPLE 5

Usage of "URC/Ringline" and "URC/Datamode/Ringline":

```
AT+CSCS="GSM"
OK
AT^SCFG?
...
^SCFG:"URC/Datamode/Ringline","off"
^SCFG:"URC/Ringline","local"
...
OK
AT^SCFG="URC/Datamode/Ringline","on"
^SCFG:"URC/Datamode/Ringline","on"
OK
AT^SCFG="URC/Ringline","asc0"
^SCFG:"URC/Ringline","asc0"
```

Switch to GSM character set.

Query all parameters.

While the TA-TE link is reserved URCs will be indicated by BREAK.

URCs on this interface will be indicated by Ring line associated to the interface (e.g. RING0 for ASC0).

While the TA-TE link is reserved URCs will be indicated by an activated "local" Ring line.

URCs on *this* interface will be indicated by an activated RING0 no matter whether or not the TA-TE link is reserved.

```
OK
AT^SCFG="URC/Datamode/Ringline","off"
^SCFG:"URC/Datamode/Ringline","off"

OK
AT^SCFG="URC/Ringline"
^SCFG:"URC/Ringline","off"
OK
```

URCs on *this* interface will be indicated by an activated RING0 if the TA-TE link is *not* reserved and by BREAK if the TA-TE link is reserved.

Disable any Ring line indication for URCs on this interface.

EXAMPLE 6

Usage of parameter `<upwd>`:

We assume that no password was configured so far (password is empty).

```
AT^SCFG="Userware/Autostart","", "1"          Correct password specification
^SCFG: "Userware/Autostart", "1"
OK
AT^SCFG="Userware/Autostart",, "1"            Incorrect password specification
+CME ERROR: invalid index
```

EXAMPLE 7

Usage of parameter `<upwd>`:

We assume that no password was configured so far (password is empty).

```
AT^SCFG="Userware/Autostart/AppName", "", "a:/smsclip-  Correct password specification.
info.jar"
^SCFG: "Userware/Autostart/AppName", "a:/smsclipinfo.jar"
OK
AT^SCFG="Userware/Autostart/AppName",, "a:/smsclip-  Incorrect password specification.
info.jar"
+CME ERROR: invalid index
```

2.15 AT^SM20 Set M20 compatibility mode

M20 is an earlier, widely used SIEMENS GSM engine. The `AT^SM20` command selects different modes of responses returned upon execution of the commands `ATD` and sms commands like e.g. `AT+CMGW`. Please note that the `AT^SM20` command has no effect on any other features and is not intended to adjust other differences between M20 and TC65.

Syntax

<p>Test Command</p> <pre>AT^SM20=?</pre> <p>Response(s)</p> <pre>OK</pre>	
<p>Read Command</p> <pre>AT^SM20?</pre> <p>Response(s)</p> <pre>^SM20:<CallMode>, <CmgwMode></pre> <pre>OK</pre>	
<p>Write Command</p> <pre>AT^SM20=<CallMode>[, <CmgwMode>]</pre> <p>Response(s)</p> <pre>OK</pre>	
<p>Reference(s)</p> <p>SIEMENS</p>	

Parameter Description

<p><code><CallMode></code>^(num)</p> <p>Call setup response mode Applies only to voice calls.</p> <p>0</p> <p>1(&F)</p>	<p>Set compatibility to Siemens mobile phones. ME will return "OK" immediately after attempting a call with the <code>ATD</code> command. In case of failure, additional call release indications, such as "NO DIAL TONE", "NO CARRIER", "BUSY" will follow.</p> <p>Default call setup mode, compatible to M20. ME will return "OK" in case of a successful connection, otherwise one of the call release indications "NO DIAL TONE", "NO CARRIER", "BUSY" are indicated.</p>
<p><code><CmgwMode></code>^(num)</p> <p>Response mode for sending and writing short messages Applies to the sms commands like e.g. <code>AT+CMGS</code> and <code>AT+CMGW</code> command.</p> <p>0</p> <p>1(&F)</p>	<p>Set compatibility to Siemens mobile phones. ME will return +CMS ERROR: <code><err></code> when writing or sending of short messages fails.</p> <p>Default mode for sending and writing short messages, compatible to M20. ME will return "OK", no matter whether or not sms command was successfully executed.</p>

3. Status Control Commands

The AT Commands described in this chapter allow the external application to obtain various status information from the TC65.

3.1 AT+CMER Mobile Equipment Event Reporting

This command controls details of the "+CIEV" URC presentation related to AT^SIND and AT+CIND. If registered via these commands the URCs are sent whenever a value of the related indicator changes.

In addition, AT+CMER controls "^SLCC" URCs related to AT^SLCC. For details refer to [Call Status Information](#), AT^SLCC and AT^SCFG, parameter <sucs>.

The read command returns the URC presentation mode <mode> and among others, the indicator event reporting status <ind>.

The write command enables and disables the presentation of "+CIEV: <indDescr>, <indValue>₁ [, <indValue>₂] [, <indValue> [, ...]]" URCs. <indDescr> refers to the name of a "+CIEV" indicator and <indValue> is the new value of this indicator. After AT+CMER has been switched on, URCs for all registered indicators will be issued. See examples provided in Section 3.2, AT+CIND and Section 3.3, AT^SIND.

Syntax

<p>Test Command</p> <p>AT+CMER=?</p> <p>Response(s)</p> <p>+CMER: (list of supported <mode>s), (list of supported <keyp>s), (list of supported <disp>s), (list of supported <ind>s), (list of supported <bfr>s)</p> <p>OK</p>	
<p>Read Command</p> <p>AT+CMER?</p> <p>Response(s)</p> <p>+CMER: <mode>, <keyp>, <disp>, <ind>, <bfr></p> <p>OK</p>	
<p>Write Command</p> <p>AT+CMER=[<mode>[, <keyp>[, <disp>[, <ind>[, <bfr>]]]]]</p> <p>Response(s)</p> <p>OK</p> <p>ERROR</p> <p>+CME ERROR</p>	
<p>Reference(s)</p> <p>GSM 07.07</p>	

Unsolicited Result Code

+CIEV: <indDescr>, <indValue>₁ [, <indValue>₂] [, <indValue> [, ...]]

A value of an indicator has changed. For more details see AT^SIND.

Parameter Description

<mode>^(num)	
0(&F)	Discard "+CIEV" and "^SLCC" URCs.
1	Discard "+CIEV" and "^SLCC" URCs when TA-TE link is reserved, e.g. in online data mode. Otherwise they are forwarded directly to the TE.
2	Buffer "+CIEV" and "^SLCC" URCs in the TA while TA-TE link is reserved, e.g. in online data mode, and flush them to the TE afterwards. Otherwise they are forwarded directly to the TE.
3	Forward "+CIEV" and "^SLCC" URCs directly to the TE. If TC65 is in online data mode, URCs are signaled via sending BREAK (100ms) and stored in a buffer. Once it is back in command mode e.g. after +++ was entered, all URCs stored in the buffer will be output.
<keyp>^(num)	
0(&F)	Keypad event reporting is not supported by TC65.
<disp>^(num)	
0(&F)	Display event reporting is not supported by TC65.
<ind>^(num)	
0(&F)	Disable indicator event reporting.
2	Enable indicator event reporting.
<bfr>^(num)	
0(&F)	TA buffer of URCs defined within this command is cleared when <mode> 1..3 is entered.
<indDescr>^(str)	
Name of indicator; for a list of all supported indicators please refer to AT+CIND and AT^SIND .	
<indValue>^(num)	
Value of indicator; for a list of all values for the supported indicators please refer to AT+CIND and AT^SIND .	

Note

- If the ME operates on different instances (MUX channels 1, 2, 3 or ASC0/ASC1) avoid different settings for routing and indicating SMS. For example, if messages shall be routed directly to one instance of the TE (set with [AT+CNMI](#), [AT^SSDA](#)), it is not possible to activate the presentation of URCs with [AT+CMER](#) or [AT+CNMI](#) on another instance. Any attempt to activate settings that conflict with existing settings on another interface, will result in CME ERROR, or accordingly CMS ERROR.

3.2 AT+CIND Indicator control

The **AT+CIND** command controls the presentation of Indicator Event Reports related to various functions such as battery charge level, signal quality, service availability, sound generation, indication of unread short messages, full SMS storage, call in progress or roaming activities.

Use of **AT+CIND** has become outdated. Rather we recommend the more powerful **AT^SIND** command which is easier to use and provides additional indicators. All indicators provided by **AT+CIND** can be handled with **AT^SIND** as well.

AT+CIND supports two ways to get the values related to indicators:

- One approach is to query the current status of each indicator by using the read command **AT+CIND?**. It returns the status no matter whether the indicator has been registered with the write command **AT+CIND=[<mode>[,<mode>[,...]]]**.
- The other way is an event-driven notification based on the "+CIEV" URCS. In this case, the ME will automatically send a message to the application, whenever the value of an indicator changes. The application should be designed to react adequately when receiving a URC.
The presentation of these URCS depends on two settings:
 - The indicators must be registered with the write command **AT+CIND=[<mode>[,<mode>[,...]]]**. When the ME is switched on all of them are in registered mode. Any indicator can be excluded if deregistered with **<mode>=0**. To register or deregister an indicator the **AT+CIND** write command requires to type the value **<mode>=1** or **0** exactly at the position where the indicator is located in the list. This is not necessary with **AT^SIND** which allows to specify indicators by name. See examples below.
 - The presentation of the registered indicators must be enabled with **AT+CMER**.

Syntax

<p>Test Command</p> <pre>AT+CIND=?</pre> <p>Response(s)</p> <pre>+CIND: (<indDescr>, list of supported <indValue>s)[, (<indDescr>, list of supported <indValue>s)[, ...]]</pre> <p>OK</p>																					
<p>Read Command</p> <pre>AT+CIND?</pre> <p>Response(s)</p> <pre>+CIND: <indValue>[, <indValue>[, ...]]</pre> <p>OK ERROR +CME ERROR: <err></p>																					
<p>Write Command</p> <pre>AT+CIND=<mode>[, <mode>[, ...]]</pre> <p>Response(s)</p> <pre>OK ERROR +CME ERROR: <err></pre>																					
<p>Reference(s)</p> <p>GSM 07.07</p>	<table border="1"> <tr> <td>PIN</td> <td>ASC0</td> <td>ASC1</td> <td>USB</td> <td>MUX1</td> <td>MUX2</td> <td>MUX3</td> <td>Charge</td> <td>→</td> <td>Last</td> </tr> <tr> <td><input type="radio"/></td> <td><input checked="" type="radio"/></td> <td><input checked="" type="radio"/></td> <td><input checked="" type="radio"/></td> <td><input checked="" type="radio"/></td> <td><input checked="" type="radio"/></td> <td><input checked="" type="radio"/></td> <td><input type="radio"/></td> <td><input checked="" type="radio"/></td> <td><input type="radio"/></td> </tr> </table>	PIN	ASC0	ASC1	USB	MUX1	MUX2	MUX3	Charge	→	Last	<input type="radio"/>	<input checked="" type="radio"/>	<input checked="" type="radio"/>	<input checked="" type="radio"/>	<input checked="" type="radio"/>	<input checked="" type="radio"/>	<input checked="" type="radio"/>	<input type="radio"/>	<input checked="" type="radio"/>	<input type="radio"/>
PIN	ASC0	ASC1	USB	MUX1	MUX2	MUX3	Charge	→	Last												
<input type="radio"/>	<input checked="" type="radio"/>	<input checked="" type="radio"/>	<input checked="" type="radio"/>	<input checked="" type="radio"/>	<input checked="" type="radio"/>	<input checked="" type="radio"/>	<input type="radio"/>	<input checked="" type="radio"/>	<input type="radio"/>												

Parameter Description

<indValue>^(num)
Integer type value, which shall be in range of corresponding **<indDescr>**

<indDescr>^(str)

String values and their <indValue> ranges.

More indications are available via [AT^SIND](#). Therefore use of [AT^SIND](#) for control of all indications is recommended.

The following indications are accessible via [AT+CIND](#):

"battchg"	Battery charge level 0..4 or 5 if no measuring is performed, e.g because no battery is connected. Also refer to AT^SBC .
"signal"	Signal quality (0..7) The indicated value is the bit error rate of the signal received. Bit errors are estimated values. See also AT+CSQ .
"service"	Service availability (0-1) 0: Not registered to any network 1: Registered to home network or, if "roam"=1 then registered to another network
"sounder"	Sounder activity (0-1) Reports every event that causes the ME to generate a tone. Value 1 means for example: Incoming call - ME is ringing. Note that the URC " +CIEV: sounder " will be output only if ringing tones are activated with AT^SRTC . Waiting call - ME generates waiting call tone (if call waiting is enabled). Outgoing call - ME generates Call Progress tone. Outgoing call - ME generates BUSY tone. The value changes to 0 when the tone stops.
"message"	Unread short message at memory location <mem1> (0-1); refer to AT+CPMS
"call"	Call in progress (0-1). Indicator value is "1" if at least one call is in state "active" or "held". Depending on the parameter <succ> selected with AT^SCFG the indicator "call" will be issued <ul style="list-style-type: none"> • when a state transition ends in state "active" or state "unknown", if <succ>="restricted", • when any state transition (including transitions beginning or ending in state "unknown") occurs in the list of active calls or when a traffic channel is established, if <succ>="verbose". Also refer to Section 7.1, Call Status Information .
"roam"	Roaming indicator (0-1) 0: Registered to home network or not registered 1: Registered to other network
"smsfull"	A short message memory storage in the MT has become full (1) or memory locations are available (0), i.e. range is (0-1)
"rsi"	Received signal (field) strength (0..5) 0: signal strength <= -112 dbm 1-4: signal strength in 15 dbm steps 5: signal strength >= -51 dbm Received signal (field) strength can also be obtained with AT+CSQ . However, the signal strength is scaled to value range 0..31 by this command.

<mode>^(num)

0	Indicator is deregistered. The indicator will not be presented as " +CIEV " URC, but can be queried with AT+CIND? .
[1] ^{(&F)(P)}	Indicator is registered, indicator event report allowed.

Notes

- Due to its restrictive value range, indicator "call" does not clearly reflect specific call states (such as alerting, active, held etc.), but rather serves to trigger the application to retrieve the new call status from the list of current calls with the AT commands [AT^SLCC](#), [AT+CLCC](#) or [AT^SCNI](#).
- If [AT^SCFG](#) setting `<succ>="verbose"`, indicator "call" will be issued also when a traffic channel is established, or when a call enters states "terminating" or "dropped" (see [Call Status Information](#)). In these cases, the relevant information about the cause of the display is available only from AT command [AT^SLCC](#).

Examples

EXAMPLE 1

<code>^SYSSTART</code>	
<code>AT+CPIN=9999</code>	
<code>OK</code>	
<code>AT+CIND?</code>	
<code>+CIND: 5,0,1,0,0,0,0,0</code>	The battery is either full or no battery is connected to the ME. The bit error rate of the signal quality is not available (since there is no call in progress). The ME is registered to its home network.
<code>OK</code>	
<code>AT+CMER=2,0,0,2</code>	Now activate the Indicator Event Report with AT+CMER .
<code>OK</code>	
<code>+CIEV: battchg,5</code>	
<code>+CIEV: signal,0</code>	
<code>+CIEV: service,1</code>	
<code>+CIEV: sounder,0</code>	
<code>+CIEV: message,0</code>	
<code>+CIEV: call,0</code>	
<code>+CIEV: roam,0</code>	
<code>+CIEV: smsfull,0</code>	
<code>+CIEV: rssi,5</code>	Full receive signal strength.
<code>ATD0123456;</code>	Make a call.
<code>OK</code>	
<code>+CIEV: sounder,1</code>	A set of "+CIEV" URCs is received.
<code>+CIEV: call,1</code>	
<code>+CIEV: sounder,0</code>	
<code>+CIEV: call,0</code>	Called party hangs up.
<code>NO CARRIER</code>	
<code>AT+CIND=,,,0,,0</code>	Deregister the indicators "sounder" and "call".
<code>OK</code>	
<code>ATD0123456;</code>	Dial the same call.
<code>OK</code>	This time, no URCs are displayed.
<code>NO CARRIER</code>	Called party hangs up.

EXAMPLE 2

Deactivation of indicator "sounder" via [AT+CIND](#)

<code>AT+CIND?</code>	Query the current status of indicators.
<code>+CIND: 5,0,1,0,1,0,0,0,4</code>	
<code>OK</code>	
<code>AT+CIND=,,,0</code>	To deactivate indicator "sounder" (= fourth item in list of indicators).
<code>OK</code>	

EXAMPLE 3

Deactivation of indicator "sounder" via [AT^SIND](#)

<code>AT^SIND="sounder",0</code>	To deactivate indicator "sounder".
<code>^SIND: sounder,0,0</code>	
<code>OK</code>	

3.3 AT^SIND Extended Indicator Control

Designed for extended event indicator control [AT^SIND](#)

- offers greater flexibility than the standard command [AT+CIND](#),
- offers several extra indicators,
- can show the current status of all indicators supported by [AT+CIND](#) and [AT^SIND](#),
- can be used to register or deregister the indicators of both commands,
- displays all indicator event reports via "+CIEV" URCs.

Presentation mode of the generated URCs is controlled via [AT+CMER](#).

The [AT^SIND](#) read command provides a list of all indicators supported by [AT+CIND](#) and [AT^SIND](#). Each indicator is represented with its registration mode and current value.

The [AT^SIND](#) write command can be used to select a single indicator in order to modify its registration and to view the current value.

Syntax

Test Command

AT^SIND=?

Response(s)

```
^SIND: (<indDescr>, list of supported <indValue>s)[, (<indDescr>, list of supported <indValue>s)[,
...]], (list of supported <mode>s)
OK
```

Read Command

AT^SIND?

Response(s)

```
^SIND: <indDescr>, <mode>, <indValue>
[^SIND: <indDescr>, <mode>, <indValue>]
...
OK
ERROR
+CME ERROR: <err>
```

Write Command

AT^SIND=<indDescr>, <mode>

Response(s)

```
^SIND: <indDescr>, <mode>, <indValue>
```

In case of: <indDescr>="eons" and <mode>=2

```
^SIND: <indDescr>, <mode>, <indValue>, <eonsOperator>, <servProvider>
```

In case of: <indDescr>="nitz" and <mode>=2

```
^SIND: <indDescr>, <mode>, <nitzUT>, <nitzTZ>, <nitzDST>
```

OK

ERROR

+CME ERROR: <err>

Reference(s)

SIEMENS

PIN ASC0 ASC1 USB MUX1 MUX2 MUX3 Charge → Last

○ ● ● ● ● ● ● ○ ● ○

Unsolicited Result Codes

URC 1

Format of the standard indicator:

+CIEV: `<indDescr>`, `<indValue>`

Value related to an indicator has changed.

URC 2

Format of the "adnread" indicator issued when accessing the ADN phonebook records stored on the SIM:

+CIEV: `<indDescr>`, `<adnEntry>`, `<adnNumber>`, `<adnType>`, `<adnText>`

+CIEV: `<indDescr>`, "READY"

One URC is issued for every used Abbreviated Dialing Number (ADN) phonebook record. After the last record of the ADN phonebook was read, a URC with "READY" tag signals end of processing.

URC 3

Format of the Voice Message indicator, if the number of waiting messages is delivered by the network:

+CIEV: `<indDescr>`, `<indValue>`, `<vmCounter>`

If the number of waiting messages is not delivered the standard indicator applies.

URC 4

Format of the "eons" indicator

+CIEV: `<indDescr>`, `<indValue>`, `<eonsOperator>`, `<servProvider>`

One URC is issued for each new LAI (Location Area Information) broadcast by the network.

URC 5

Format of the "nitz" indicator:

+CIEV: `<indDescr>`, `<nitzUT>`, `<nitzTZ>`, `<nitzDST>`

Parameter Description

`<indDescr>`^(str)

String values and their `<indValue>` ranges.

All indicators supported by `AT+CIND` are accessible with this command, too. A detailed description of these indicators can be found there.

The following indicators are accessible via `AT^SIND` only:

"audio"	Activity of the built-in audio unit. 0 Audio unit not active. 1 Value 1 means for example: Outgoing voice call: Indicator appears when dialing starts. Incoming voice call: Indicator appears prior to the RING result code.
"vmwait1"	Voice Message Waiting Indication for line 1 0 The value 0 notifies that no new voice message is available, and is provided by the service center to clear the voice message indication after the subscriber has retrieved all voice messages. 1 The value 1 notifies the subscriber that the mailbox contains one or several messages. "vmwait1" and "vmwait2" indicate the receipt of a special short message with a Voice Message Waiting Indicator. The service must be provisioned by the operator. The numbers 1 or 2 in "vmwait1" and "vmwait2" are related to the two lines of the Alternate Line Service (ALS), also defined in CPHS Phase 2 standard. For further details refer to the <code>AT^SALS</code> command. The presentation mode of the indicator varies with the operator: If more than one message are waiting, some operators only indicate the first one, others deliver the indicator each time a new voice message is put into the mailbox.

After the subscriber has retrieved all voice messages the service center automatically sends another message indication which provides the value 0.

Some operators may also send the number of waiting voice messages along with the indication. In this case, the number will be displayed by the TC65 as part of the URC. For example, "+CIEV: vmwait1,1,5" notifies that five new voice messages are waiting. However, it should be noted that neither the read command `AT^SIND?` nor the write command `AT^SIND=<mode>,2` display the number of waiting messages.

The "vmwait" indicators do not apply if a network provider signals new voice mail(s) via standard SMS. In this case the indicator "message" will be displayed (see `AT+CIND`).

"vmwait2"

Voice Message Waiting Indication for line 2

0 See description of "vmwait1".

1 See description of "vmwait1".

"ciphcall"

Ciphering Status Change Indication

0 Current call or SMS is not ciphered.

1 Current call or SMS is ciphered.

As stated in GSM specifications 02.07 and 02.09 the ciphering indicator feature allows the TC65 to detect that ciphering is not switched on and to indicate this to the user.

The ciphering indicator feature may be disabled by the home network operator setting data in the "administrative data" field (EF_{AD}) in the SIM, as defined in GSM 11.11.

If this feature is not disabled by the SIM, then whenever a connection is in place, which is, or becomes unenciphered, an indication shall be given to the user. This enables the user's decision how to proceed.

Read command returns valid ciphering status only if a call is in progress or active.

If EF_{AD} setting disables the ciphering indicator feature read command always indicates a ciphered link and no URC presentation will take place.

The following restrictions apply if the same serial channel is used for `AT^SIND` "ciphcall" indication and for the action triggering this URC. In general, the recommended solution is to use a dedicated channel for all status signalling via URCs.

- If an unciphered mobile originated SMS is performed, `AT^SIND` "ciphcall" URCs on the same serial channel will be issued after the related "OK" and indicate the ciphering state at *this* time. Because the SMS is already sent at this time, two URCs will be issued on this channel, but both are indicating that ciphering is enabled.
- If an unciphered mobile originated data call is performed, `AT^SIND` "ciphcall" URCs on the same serial channel will be issued after the interface is no longer blocked by the call (call is released or temporarily stopped) and indicate the ciphering state at *this* time.

"adnread"

Abbreviated Dialing Number (ADN) Phonebook Read Indication

0 Phonebook reading is not finished.

1 Phonebook reading is finished.

Every time after entering the `AT+CPIN` the module starts reading the ADN phonebook. This can be used to enable the TE to output the phonebook records as URCs. The advantage is that the user does not need to wait until the phonebook read command `AT+CPBR` is accessible after entering the SIM PIN (depending on the SIM card this may take up to 30 seconds without RSA or 2 minutes with RSA).

If `<mode>=1` all used ADN phonebook records stored on the SIM will be output as URCs after SIM PIN authentication has been performed successfully. A URC with "READY" tag issued at the end of the list indicates that TC65 has finished reading the phonebook.

Note that the settings of `AT^SIND` and `AT+CMER` will be restored to their default values when restarting the TC65. Therefore it is recommended that the set-

tings be enabled before entering the SIM PIN. This can be done, for example, after rebooting the TC65.

“eons“

Enhanced Operator Name String (EONS) Indication

The Enhanced Operator Name String indicator feature allows the TC65 to output various operator names for different PLMN identities via URC. It also allows the output of a different operator name based on a subset of the registered network by using a range of Location Area Codes (LACs) or a single LAC.

The presentation of the "eons" indicator is determined by network activity. For example, the indicator appears every time a location update occurs or a NITZ information is sent, no matter whether or not the status of the EONS information has changed. This means that the same EONS information may be reported several times.

The EONS tables are stored in the SIM card and will be read at power-up.

Following are the SIM Elementary Files that are affected by the introduction of EONS feature in the SIM card:

EF_{SST} (SIM Service Table) - describes which features are active.

EF_{OPL} (Operator PLMN List) - contains the PLMN identification and location ID together with the index of the corresponding PNN record

EF_{PNN} (PLMN Network Name) - contains the full and short form version of the network name for the registered PLMN

If the Operator Name Source is CPHS Operator Name String long and short form, refer to <indValue>, the following two SIM Elementary Files will be used:

EF_{ONString} (Operator Name String) - contains the name of the PLMN operator who issued the SIM.

EF_{OPShort} (Operator Name Short form) - contains a short form of the name of the PLMN operator who issued the SIM.

“nitz“

Network Identity and Time Zone indication

This indicator shows the time relevant information elements of an MM Information (MMI) or GMM Information (GMMI) message received from the network (see GSM 24.008, ch. 9.2.15a and 9.4.19). The network usually sends a NITZ indicator when the mobile attaches to the network, when it enters a location area with different time zone or when a daylight change occurs.

A NITZ indicator may consist of the following parameters: Universal Time (UT), local Time Zone (TZ), Daylight Saving Time (DST). All information elements of MMI/GMMI are optional and therefore, the presentation of the parameters <nitzUT>, <nitzTZ>, <nitzDST> varies with the network. For example, the network may send all three parameters UT, TZ, DST, or only UT and TZ or only TZ.

UT is indicated in usual date/time format and represents the current world time (GMT) at the moment when sent.

TZ is given as a positive (east) or negative (west) offset from UT in units of 15 minutes.

DST shows the number of hours added to the local TZ because of daylight saving time (summertime) adjustment. Usually DST is 1 hour but it can be also 2 hours in certain locations.

Example for time and time zone with DST:

+CIEV: nitz,"04/07/23,13:39:20",-28,1

In this example TZ is -28, showing a time offset of -7 hours (west) to Universal Time/GMT (which never changes for DST). DST is 1 which indicates that one hour was added to TZ because of Daylight Saving Time. If a network does not send the DST parameter the TZ value would be -32 (8 hours west) as would be done in winter:

+CIEV: nitz,"04/11/23,13:39:20",-32

Please be aware that despite the last NITZ value can be looked up again via "AT^SIND=nitz,2" the returned values may be out of date. Especially the UT value is obsolete because there is no internal NITZ clock and therefore no con-

tinuation of UT.

NITZ values are lost when the module detaches from network. Also when a manual network selection fails and the module automatically falls back to the previous network the NITZ values cannot be recalled. Nevertheless an indicated time zone is valid until a new MMI/GMMI will trigger another NITZ indication.

“band“

Currently selected frequency band or band combination.

1...14 Identical with `<rbc>` of `AT^SCFG`. The value indicates the bands(s) currently available for network selection, depending on the network configuration either a single band or a dualband combination. The URC appears whenever the status of the currently available band(s) changes, for example after using the `AT^SCFG` command to change the "Radio/Band" parameters `<rba>` or `<rbbp>`. Please see `AT^SCFG` for further detail about the feature "Radio/Band" selection.

`<indValue>`^(num)

Integer type value in the range stated above for the corresponding `<indDescr>`.

Notes specific to the EONS feature:

If the indicator is "eons", the `<indValue>` is a type associated to the operator name according to GSM 22.101 [26]. This type depends on the source of the operator name.

Priority of types associated to the operator names is defined as follows (the type listed first has the highest priority). If a type cannot be indicated the next one will be used.

- | | |
|---|--|
| 0 | Not registered. |
| 1 | EF-OPL and EF-PNN (alphanumeric format, can contain up to 24 characters.) |
| 2 | Operator Name String in long and short format according to Common PCN Handset Specification (CPHS) [27] (alphanumeric format, can contain up to 16 characters). |
| 3 | Name information received by the NITZ service long and short form (alphanumeric format, can contain up to 16 characters). The short form will be displayed only if EF _{OPShort} from CPHS is available. |
| 4 | Any operator name stored internal to the ME (alphanumeric format, can contain up to 16 characters). |
| 5 | Broadcast MCC-MNC (numeric format which consists of a 3-digit country code plus a 2- or 3-digit network code). |

If the type is 2, 4 or 5, `AT+COPS` with the appropriate `<mode>` displays the same operator name.

`<mode>`^(num)

- | | |
|---|--|
| 0 | Indicator is deregistered, i.e. no such indicator event report (URC) will be issued. <code><mode>=0</code> is power-up and factory default of indicators defined by <code>AT^SIND</code> only. |
| 1 | Indicator is registered. <ul style="list-style-type: none"> • Indicator event reports are controlled via <code>AT+CMER</code>. • All indicators can be registered or deregistered via <code>AT^SIND</code>, but different default settings apply: Power-up and factory default of the indicators supported by <code>AT+CIND</code> is <code><mode>=1</code>, while, as stated above, indicators defined by <code>AT^SIND</code> only are set to <code><mode>=0</code>. |
| 2 | Query the registration status and the current value of a single indicator type. |

`<adnEntry>`^(num)

ADN phonebook record number on the SIM.

`<adnNumber>`^(str)

Phone number, for further details see `AT+CPBR`.

<adnType>^(num)

Address type, for further details see [AT+CPBR](#).

- | | |
|-----|---|
| 145 | Dialing string <adnNumber> includes international access code character '+'.
Dialing string <adnNumber> contains printable non-alphabetic non-digit characters saved with the number string. |
| 209 | |
| 129 | otherwise |

<adnText>^(str)

Text assigned to a phone number. For further details see [AT+CPBR](#).

<vmCounter>

If delivered by the network: Number of new voice messages sent as part of the Voice Message Waiting Indicator. Refer to <indDescr>.

<eonsOperator>

Operator in format which depends on the type associated to the operator name. Refer to <indValue>.

<servProvider>^(str)

Service Provider Name according to the status settings (SIM Service No. 17) in the SIM Service Table (SST) of the SIM.

<nitzUT>

Universal Time delivered as part of the "nitz" Indicator. Refer to <indDescr>.

<nitzTZ>

Time Zone delivered as part of the "nitz" Indicator. Refer to <indDescr>.

<nitzDST>

Adjustment for Daylight Saving Time as part of the "nitz" Indicator. Refer to <indDescr>.

Example

Activation and use of indicator "audio":

AT^SIND="audio",1	You register the indicator "audio".
^SIND: audio,1,0	
OK	
AT+CMER=2,,2	You activate the Indicator Event Report with AT+CMER .
OK	A set of all registered URCs is presented. (Please note that the example includes the indicators registered due to the power-up default settings of AT+CIND .)
+CIEV: battchg,5	
+CIEV: signal,99	
+CIEV: service,1	
+CIEV: sounder,0	
+CIEV: message,1	
+CIEV: call,0	
+CIEV: roam,0	
+CIEV: smsfull,0	
+CIEV: rssi,4	

```
+CIEV: audio,0
ATD030123456           You make a call.
OK
+CIEV: audio,1
+CIEV: sounder,1
+CIEV: call,1
+CIEV: signal,0
+CIEV: sounder,0
ATH                   You hang up.
OK
+CIEV: call,0
+CIEV: rssi,3
+CIEV: audio,0
+CIEV: signal,99
+CIEV: rssi,4
```

3.4 AT+CEER Extended Error Report

AT+CEER returns an extended error report regarding the reason of the last

- call release
- failure to set up a call (both mobile originated or terminated)
- failure to modify a call by using Supplementary Services
- failed attempt to activate, register, query, deactivate or deregister a Supplementary Service
- unsuccessful GPRS attach or unsuccessful PDP context activation
- GPRS detach or PDP context deactivation

The release cause report is presented in numeric format. Default output in case of a none-error-situation is +CEER: 0,0,0. A description associated with each number can be found in the tables given in the following sub-clauses and the relevant GSM specifications.

The first parameter <locationID> serves to locate the other two parameters. Depending on the failure or release cause either <reason> or <ssRelease> are applicable, i.e. if <reason> ≠ 0, then <ssRelease> = 0. Vice versa, if <reason> = 0, then <ssRelease> may be ≠ 0.

AT+CEER is not available for data calls, please use AT+SI18=1 instead.

Syntax

<p>Test Command</p> <p>AT+CEER=?</p> <p>Response(s)</p> <p>OK</p> <p>ERROR</p> <p>+CME ERROR</p>	
<p>Exec Command</p> <p>AT+CEER</p> <p>Response(s)</p> <p>+CEER: <locationID>, <reason>, <ssRelease></p> <p>OK</p> <p>ERROR</p> <p>+CME ERROR</p>	
<p>Reference(s)</p> <p>GSM 07.07</p>	

Parameter Description

<locationID>^(num)

Location ID as number code. Location IDs are listed in Section 3.4.1, Cause Location ID for the extended error report. Each ID is related with another table that contains a list of <reason>s or <ssRelease>s.

<reason>^(num)

Reason for last call release as number code. The number codes are listed in several tables, sorted by different categories in the following subclauses. The tables can be found proceeding from the Location ID given in Section 3.4.1, Cause Location ID for the extended error report.

<ssRelease>^(num)

Release cause for last Supplementary Service call (listed in Section 3.4.5, GSM Release cause for Supplementary Service Call) or last call related use of a Supplementary Service (listed in Section SIEMENS release cause for Call-related Supplementary Services (CRSS)).

Examples

EXAMPLE 1

<pre>ATD"01751223344"; NO CARRIER AT+CEER +CEER: 8,21,0 OK</pre>	<p>A mobile originated call is rejected by the remote party. Call setup is terminated with NO CARRIER. To check the cause, the caller enters AT+CEER. The Location ID 8 in Section 3.4.1 points to Section 3.4.4, where 21 = "Call rejected". 0 = "No error" as value of <ssRelease> stands for parameter is not applicable.</p>
--	--

EXAMPLE 2

The user attempts to set up a multiparty call, though there are only two parties involved in the present conversation:

<pre>ATD"01751223344"; OK AT+CHLD=2 OK AT+CHLD=3 +CME ERROR: operation temporary not allowed AT+CEER +CEER: 22,0,2 OK</pre>	<p>The Location ID 22 in Section 3.4.1 points to Section SIEMENS release cause for Call-related Supplementary Services (CRSS), where 2 = "Initial conditions not fulfilled (one active, one held call)". 0 = "No error" as value of <reason> stands for parameter is not applicable.</p>
---	--

EXAMPLE 3

The user attempts to activate call barring. Activation is denied by the network since the password is blocked after previous failures to enter the password.

<pre>AT+clck=oi,1,"0000",3; +CME ERROR: incorrect password AT+CEER +CEER: 35,0,43 OK</pre>	<p>The Location ID 35 in Section 3.4.1 points to Section 3.4.5, where 43 = "NumberOfPWAttemptsViolation" may mean that a wrong password has been entered for more than 3 times. 0 = "No error" as value of <reason> stands for parameter is not applicable.</p>
--	---

3.4.1 Cause Location ID for the extended error report

ID	Description
0	No error (default)
2	GSM cause for L3 Radio Resource Sublayer (GSM 04.08 annex F)
4	GSM cause for L3 Mobility Management (GSM 04.08 annex G)
6	GSM cause for L3 Mobility Management via MMR-SAP (GSM 04.08 annex G)
8	GSM cause for L3 Call Control (GSM 04.08 10.5.4.11 and annex H)
12	GSM cause for L3 SMS CP Entity
14	GSM cause for L3 SMS RL Entity
16	GSM cause for L3 SMS TL Entity
21	GSM cause for L3 Call-related Supplementary Services
34	Network cause for Supplementary Services (GSM 04.08 10.5.4.11 and annex H)
35	Supplementary Services network error (GSM 04.80 3.6.6)
48	GSM cause for GPRS Mobility Management (GSM 04.08 annex G.6)

ID	Description
50	GSM cause for Session Management (GSM 04.08 annex I)
128	Supplementary Services general problem (GSM 04.80 3.6.7)
129	Supplementary Services invoke problem (GSM 04.80 3.6.7)
130	Supplementary Services result problem (GSM 04.80 3.6.7)
131	Supplementary Services error problem (GSM 04.80 3.6.7)
241	SIEMENS cause for GPRS API
243	SIEMENS cause for PPP/IP-Stack

3.4.2 GSM release cause for L3 Radio Resource (RR)

Number	Description
0	Normal event
1	Abnormal release, unspecified
2	Abnormal release, channel unacceptable
3	Abnormal release, timer expired
4	Abnormal release, no activity on the radio path
5	Pre-emptive release
8	Handover impossible, timing advance out of range
9	Channel mode unacceptable
10	Frequency not implemented
65	Call already cleared
95	Semantically incorrect message
96	Invalid mandatory information
97	Message type non-existent or not implemented
98	Message type not compatible with protocol state
100	Conditional information element error
101	No cell allocation available
111	Protocol error unspecified

3.4.3 GSM release cause for Mobility Management (MM)

Number	Description
Causes related to MS identification	
2	IMSI unknown in HLR
3	Illegal MS
4	IMSI unknown in VLR
5	IMEI not accepted
6	Illegal ME
Cause related to subscription options	
11	PLMN not allowed

Number	Description
12	Location Area not allowed
13	Roaming not allowed in this location area
Causes related to PLMN specific network failures and congestion	
17	Network failure
22	Congestion
Causes related to nature of request	
32	Service option not supported
33	Requested service option not subscribed
34	Service option temporarily out of order
38	Call cannot be identified
Causes related to invalid messages	
95	Semantically incorrect message
96	Invalid mandatory information
97	Message type non-existent or not implemented
98	Message not compatible with protocol state
99	Information element non-existent or not implemented
100	Conditional information element error
101	Messages not compatible with protocol state
111	Protocol error, unspecified
Causes related GPRS	
7	GPRS services not allowed
8	GPRS services not allowed in combination with non-GPRS services
9	MS identity cannot be identified by the network
10	Implicitly detached
14	GPRS services not allowed in current PLMN
16	MSC temporarily unreachable

3.4.4 GSM release cause for L3 Call Control (CC)

Number	Description
0	No error
Normal class	
1	Unassigned (unallocated) number
3	No route to destination
6	Channel unacceptable
8	Operator determined barring
16	Normal call clearing
17	User busy
18	No user responding
19	User alerting, no answer
21	Call rejected

Number	Description
22	Number changed
25	Pre-emption
26	Non-selected user clearing
27	Destination out of order
28	Invalid number format (incomplete number)
29	Facility rejected
30	Response to STATUS ENQUIRY
31	Normal, unspecified
Resource unavailable class	
34	No circuit/channel available
38	Network out of order
41	Temporary failure
42	Switching equipment congestion
43	Access information discarded
44	Requested circuit/channel not available
47	Resource unavailable, unspecified
Service or option not available class	
49	Quality of service unavailable
50	Requested facility not subscribed
55	Incoming calls barred within the CUG
57	Bearer capability not authorized
58	Bearer capability not presently available
63	Service or option not available, unspecified
Service or option not implemented	
65	Bearer service not implemented
68	ACM equal or greater than ACMmax
69	Requested facility not implemented
70	Only restricted digital information bearer capability is available
79	service or option not implemented, unspecified
Invalid message (e.g. parameter out of range) class	
81	Invalid transaction identifier value
87	User not member of CUG
88	Incompatible destination
91	Invalid transit network selection
95	Semantically incorrect message
Protocol error (e.g. unknown message) class	
96	Invalid mandatory information
97	Message type non-existent or not implemented
98	Message type not compatible with protocol state
99	Information element non-existent or not implemented
100	Conditional information element error
101	Message not compatible with protocol

Number	Description
102	Recovery on timer expiry
111	Protocol error, unspecified
Interworking class	
127	Interworking, unspecified

3.4.5 GSM Release cause for Supplementary Service Call

Number	Description
0	No error (default)
1	UnknownSubscriber
9	IllegalSubscriber
10	BearerServiceNotProvisioned
11	TeleserviceNotProvisioned
12	IllegalEquipment
13	CallBarred
15	CUGReject
16	IllegalSSOperation
17	SSErrorStatus
18	SSNotAvailable
19	SSSubscriptionViolation
20	SSIncompatibility
21	FacilityNotSupported
27	AbsentSubscriber
29	ShortTermDenial
30	LongTermDenial
34	SystemFailure
35	DataMissing
36	UnexpectedDataValue
37	PWRegistrationFailure
38	NegativePWCheck
43	NumberOfPWAttemptsViolation
71	UnknownAlphabet
72	USSDBusy
126	MaxNumsOfMPTYCallsExceeded
127	ResourcesNotAvailable
General Problem Codes	
300	Unrecognized Component
301	Mistyped Component
302	Badly Structured Component
Invoke Problem Codes	
303	Duplicate Invoke ID

Number	Description
304	Unrecognized Operation
305	Mistyped Parameter
306	Resource Limitation
307	Initiating Release
308	Unrecognized Linked ID
309	Linked Response Unexpected
310	Unexpected Linked Operation
Return Result Problem Codes	
311	Unrecognize Invoke ID
312	Return Result Unexpected
313	Mistyped Parameter
Return Error Problem Codes	
314	Unrecognized Invoke ID
315	Return Error Unexpected
316	Unrecognized Error
317	Unexpected Error
318	Mistyped Parameter

3.4.6 GSM cause for L3 Protocol module or other local cause

Number	Description
2	No detailed cause

3.4.7 SIEMENS release cause for GPRS API

Number	Description
0	Regular deactivation of the call
1	Action temporarily not allowed
2	Wrong connection type
3	Specified data service profile invalid
4	PDP type or address is unknown
5	FDN Check was not successful; GPRS Attach and PDP Context Activation blocked
255	Undefined

3.4.8 SIEMENS release cause for PPP/IP-Stack

Number	Description
0	Regular call deactivation
1	LCP stopped
255	Undefined

3.5 ATS18 Extended call release report

ATS18 controls the presentation of extended call release reports for circuit switched fax and data calls. Extended call release reports related to voice calls are controlled via AT+CEER.

The call release report is presented in numeric format and shows as follows:

+CAUSE: <locationID>:<reason>

If enabled the message will be reported every time a fax or data call is released or fails to be established.

Syntax

Read Command	
ATS18?	
Response(s)	
<n>	
OK	
Write Command	
ATS18=<n>	
Response(s)	
OK	
ERROR	
Reference(s)	
V.250	

PIN	ASC0	ASC1	USB	MUX1	MUX2	MUX3	Charge	→	Last
<input type="radio"/>	<input checked="" type="radio"/>	<input type="radio"/>	<input checked="" type="radio"/>	<input checked="" type="radio"/>	<input type="radio"/>	<input type="radio"/>	<input type="radio"/>	<input checked="" type="radio"/>	<input type="radio"/>

Parameter Description

<n>^{(num)(&W)(&V)}

An odd number enables the presentation of the extended call release report. Any even number disables this feature.

0(&F)...255

<locationID>^(num)

Location ID as number code, see also <locationID> of AT+CEER.

Location IDs are listed in Section 3.4.1, Cause Location ID for the extended error report. Each ID is related to another table that contains a list of <reason>s.

<reason>^(num)

Reason for last call release as number code (see also <reason> of AT+CEER).

<reason> numbers and the associated descriptions are listed in several tables, sorted by different categories at AT+CEER. The tables can be found proceeding from the Location IDs listed in Section 3.4.1, Cause Location ID for the extended error report.

Examples

EXAMPLE 1

ATS18=1	Enables the presentation of extended call release reports.
OK	
ATD03012345678	Now, a mobile originated data call fails.
+CAUSE: 8:17	An extended error report is output, followed by the result code BUSY.
BUSY	The Location ID 8 stated in Section 3.4.1 points to Section 3.4.4, with 17 = "User busy".

EXAMPLE 2

ATS18=1	Enables the presentation of extended call release reports.
OK	
ATD03012345678	Now, a mobile originated data call is set up.
CONNECT 9600/RLP	
Hello,	
+++	Call ends after remote party hung up.
+CAUSE: 8:16	Normal call release is reported, followed by the result code NO CARRIER.
NO CARRIER	The Location ID 8 stated in Section 3.4.1 points to Section 3.4.4, with 16 = "Normal call clearing".

3.6 AT+CPAS Mobile equipment activity status

The `AT+CPAS` execute command indicates the activity status of the ME.

Syntax

Test Command AT+CPAS=? Response(s) +CPAS: (list of supported<pas>s) OK	Exec Command AT+CPAS Response(s) +CPAS: <pas> OK	Reference(s) GSM 07.07	PIN ASC0 ASC1 USB MUX1 MUX2 MUX3 Charge ↗ Last ○ ● ● ● ● ● ● ○ ● ○
--	--	---------------------------	---

Parameter Description

<pas> ^(num)	
0	Ready
3	Incoming call (ringing)
4	Call in progress or call hold

3.7 AT+WS46 Select wireless network

Syntax

Test Command

```
AT+WS46=?
```

Response(s)

```
+WS46: (list of supported<n>s)  
OK
```

Read Command

```
AT+WS46?
```

Response(s)

```
<n>  
OK
```

Write Command

```
AT+WS46=<n>
```

Response(s)

```
OK  
ERROR  
+CME ERROR
```

Reference(s)

GSM 07.07

PIN ASC0 ASC1 USB MUX1 MUX2 MUX3 Charge  Last

Parameter Description

<n>^(num)

12 GSM digital cellular

4. Serial Interface Control Commands

The AT Commands described in this chapter allow the external application to determine various settings related to the TC65's serial interface.

4.1 AT\Q Flow control

Syntax

Exec Command	
AT\Q[<n>]	
Response(s)	
OK	
If RTS/CTS flow control is not supported by interface and <n> is 2 or 3: ERROR	
Reference(s)	PIN ASC0 ASC1 USB MUX1 MUX2 MUX3 Charge ↗ Last
SIEMENS	<input type="radio"/> <input checked="" type="radio"/> <input checked="" type="radio"/> <input checked="" type="radio"/> <input type="radio"/> <input type="radio"/> <input type="radio"/> <input type="radio"/> <input type="radio"/> <input checked="" type="radio"/> <input type="radio"/>

Parameter Description

<n> ^{(num)(&W)(&V)}	
[0] ^(&F)	Disable flow control
1	XON/XOFF software flow control
2	Only CTS by DCE (TA)
3	RTS/CTS hardware flow control Recommended for the following procedures: incoming or outgoing data calls, fax calls, MUX mode. Often, the initialization routine of Fax programs includes enabling RTS/CTS handshake, eliminating the need to issue AT\Q3 once again.

Notes

- When using XON/XOFF flow control (AT\Q1) in online mode, +++ should not be used while the data transmission is paused with XOFF. Before entering the command mode with +++ the paused transmission should be resumed using the XON character.
- For compatibility reasons, the AT\Q command can be used in Multiplex mode, though the settings will not take effect. However, be aware that whenever you use the AT\Q write command in Multiplex mode and then save the current configuration to the user profile with AT&W, the changed AT\Q setting will become active after restart.
- Flow control can also be set using AT+IFC.

4.2 AT&C Set circuit Data Carrier Detect (DCD) function mode

The **AT&C** command determines how the state of circuit 109 (DCD) relates to the detection of received line signal from the distant end.

Syntax

Exec Command	
AT&C[<value>]	
Response(s)	
OK	
Reference(s)	PIN ASC0 ASC1 USB MUX1 MUX2 MUX3 Charge → Last
V.250	<input type="radio"/> <input checked="" type="radio"/> <input type="radio"/> <input checked="" type="radio"/> <input checked="" type="radio"/> <input checked="" type="radio"/> <input checked="" type="radio"/> <input checked="" type="radio"/> <input type="radio"/> <input checked="" type="radio"/> <input type="radio"/>

Parameter Description

<value> ^{(num)(&W)(&V)}	
[0]	DCD line is always ON
1 ^(&F)	DCD line is ON in the presence of data carrier only

4.3 AT&D Set circuit Data Terminal Ready (DTR) function mode

The **AT&D** determines how the TA responds when circuit 108/2 (DTR) is changed from ON to OFF during data mode.

Syntax

Exec Command																					
AT&D[<value>]																					
Response(s)																					
OK																					
Reference(s)	<table border="1"> <tr> <td>PIN</td> <td>ASC0</td> <td>ASC1</td> <td>USB</td> <td>MUX1</td> <td>MUX2</td> <td>MUX3</td> <td>Charge</td> <td>→</td> <td>Last</td> </tr> <tr> <td><input type="radio"/></td> <td><input checked="" type="radio"/></td> <td><input type="radio"/></td> <td><input checked="" type="radio"/></td> <td><input checked="" type="radio"/></td> <td><input checked="" type="radio"/></td> <td><input checked="" type="radio"/></td> <td><input type="radio"/></td> <td><input checked="" type="radio"/></td> <td><input type="radio"/></td> </tr> </table>	PIN	ASC0	ASC1	USB	MUX1	MUX2	MUX3	Charge	→	Last	<input type="radio"/>	<input checked="" type="radio"/>	<input type="radio"/>	<input checked="" type="radio"/>	<input checked="" type="radio"/>	<input checked="" type="radio"/>	<input checked="" type="radio"/>	<input type="radio"/>	<input checked="" type="radio"/>	<input type="radio"/>
PIN	ASC0	ASC1	USB	MUX1	MUX2	MUX3	Charge	→	Last												
<input type="radio"/>	<input checked="" type="radio"/>	<input type="radio"/>	<input checked="" type="radio"/>	<input checked="" type="radio"/>	<input checked="" type="radio"/>	<input checked="" type="radio"/>	<input type="radio"/>	<input checked="" type="radio"/>	<input type="radio"/>												
V.250																					

Parameter Description

<value> ^{(num)(&W)(&V)}	Description
[0]	TA ignores status of DTR.
1	ON->OFF on DTR: Change to command mode while retaining the connected call.
2(&F)	ON->OFF on DTR: Disconnect data call, change to command mode. During state DTR = OFF auto-answer is off.

4.4 AT&S Set circuit Data Set Ready (DSR) function mode

The [AT&S](#) command determines how the TA sets circuit 107 (DSR) depending on the communication state of the TA interfacing TE.

Syntax

Exec Command	
AT&S[<value>]	
Response(s)	
OK	
Reference(s)	PIN ASC0 ASC1 USB MUX1 MUX2 MUX3 Charge ↗ Last
V.250	<input type="radio"/> <input checked="" type="radio"/> <input type="radio"/> <input checked="" type="radio"/> <input checked="" type="radio"/> <input checked="" type="radio"/> <input checked="" type="radio"/> <input checked="" type="radio"/> <input type="radio"/> <input checked="" type="radio"/> <input type="radio"/>

Parameter Description

<value> ^{(num)(&W)(&V)}	
[0] ^(&F)	DSR line is always ON
1	TA in command mode: DSR is OFF. TA in data mode: DSR is ON.

4.5 ATE Enable command echo

The [ATE](#) command determines whether or not the TA echoes characters received from TE during command state.

Syntax

Exec Command	
ATE[<value>]	
Response(s)	
OK	
Reference(s)	PIN ASC0 ASC1 USB MUX1 MUX2 MUX3 Charge ↗ Last
V.250	<input type="radio"/> <input checked="" type="radio"/> <input checked="" type="radio"/> <input checked="" type="radio"/> <input checked="" type="radio"/> <input checked="" type="radio"/> <input checked="" type="radio"/> <input checked="" type="radio"/> <input type="radio"/> <input checked="" type="radio"/> <input type="radio"/>

Parameter Description

<value> ^{(num)(&W)(&V)}	
[0]	Echo mode off
1 ^(&F)	Echo mode on

Notes

- In case of using the command without parameter, <value> is set to 0.
- When a Java application is running there is no echo available, existing settings are ignored and attempts to change the settings are disregarded.

4.6 AT+ICF Serial Interface Character Framing

The command `AT+ICF` controls the serial interface character framing format and parity used for receiving and transmitting.

The following settings are supported:

- 7 bits, even parity, 1 stop bit (`AT+ICF=5,1`)
- 7 bits, odd parity, 1 stop bit (`AT+ICF=5,0`)
- 8 bits, even parity, 1 stop bit (`AT+ICF=2,1`)
- 8 bits, no parity, 1 stop bit (`AT+ICF=3`)
- 8 bits, odd parity, 1 stop bit (`AT+ICF=2,0`)
- 8 bits, no parity, 2 stop bits (`AT+ICF=1`)

Syntax

<p>Test Command</p> <pre>AT+ICF=?</pre> <p>Response(s)</p> <pre>+ICF: (list of supported <format>s), (list of supported <parity>s) OK</pre>	
<p>Read Command</p> <pre>AT+ICF?</pre> <p>Response(s)</p> <pre>+ICF: <format>[, <parity>] OK</pre>	
<p>Write Command</p> <pre>AT+ICF=[<format>][, <parity>]</pre> <p>Response(s)</p> <pre>OK ERROR</pre>	
<p>Reference(s)</p> <p>V.250</p>	

Parameter Description

<code><format></code> ^{(num)(&W)(&V)}	
Specifies the character format used for receiving and transmitting.	
1	8 data 0 parity 2 stop
2	8 data 1 parity 1 stop
[3]	8 data 0 parity 1 stop
5	7 data 1 parity 1 stop
<code><parity></code> ^{(num)(&W)(&V)}	
Specifies the method of calculating the parity bit, if a parity bit is supported by <code><format></code> . If <code><format></code> does not support parity, this parameter has to be omitted.	
0	odd
1	even

Notes

- If **AT+ICF** modes 7E1 or 7O1 are set, the parity bit will by default not be transmitted over the air. If the remote party expects the parity bit to be transmitted, additional settings are required via **AT^STPB**.
- When using a bit rate of 300 bps there must be a delay of 500ms before entering the next command. At bit rates of 1200 bps the delay must be 300ms. For higher bit rates use of the default delay is sufficient.
- TC65's autobaud feature detects the bit rate currently used by the TE. However, this detection suffers some limitations described in Section 4.9.1, **Autobauding**. If autobauding is enabled, the **AT+ICF** read command does not show the current character framing, but the character framing that will be used when autobauding is disabled.
- For compatibility reasons, the command can be used in Multiplex mode, though the settings will not take effect. Please note that changes made on multiplex channel 1 will be saved with **AT&W** and will become active when restarting the ME after **AT^SMSO**.
- To start the multiplexer it is necessary to set the character framing to 8 bits, no parity and 1 stop bit.
- If a **<format>** is selected without parity (e.g. **<format>=3**) and you try to activate a format with parity (e.g. **<format>=2**), you need to explicitly set the parameter **<parity>** (e.g. **AT+ICF=2,1**). Otherwise you will get '+CME ERROR: invalid index'. This is because for **<format>=3**, the parameter **<parity>** is set to the internal value 'no parity' which is not supported by **<format>=2**. (Remember that if an optional parameter is omitted for which no default is stated in this specification, the value of the parameter remains unchanged).

4.7 AT+IFC Set Flow Control separately for data directions

The command `AT+IFC` can be used to set or query the data flow control separately for each data direction. In contrast to this, flow control settings made with `AT\Q` are valid in both data directions.

Syntax

<p>Test Command</p> <pre>AT+IFC=?</pre> <p>Response(s)</p> <pre>+IFC: (list of supported <TEflowcontrol>s), (list of supported <TAflowcontrol>s) OK</pre>	
<p>Read Command</p> <pre>AT+IFC?</pre> <p>Response(s)</p> <pre>+IFC: <TEflowcontrol>, <TAflowcontrol> OK</pre>	
<p>Write Command</p> <pre>AT+IFC=<TEflowcontrol>, <TAflowcontrol></pre> <p>Response(s)</p> <pre>OK ERROR</pre>	
<p>Reference(s)</p> <p>V.250</p>	

Parameter Description

`<TEflowcontrol>`^{(num)(&W)}

Specifies the method used by the TE when receiving data from the TA.

- | | |
|-----|--|
| [0] | none |
| 1 | XON/XOFF, terminate flow control in the Cellular Engine |
| 2 | RTS line |
| 3 | XON/XOFF, evaluate flow control in the Cellular Engine and pass it through (over the air) to the opposite TE |

`<TAflowcontrol>`^{(num)(&W)}

Specifies the method used by the TA when receiving data from the TE.

- | | |
|-----|----------|
| [0] | none |
| 1 | XON/XOFF |
| 2 | CTS line |

Notes

- When using XON/XOFF flow control (`AT+IFC=1,x` or `AT+IFC=3,x`) in data mode, `+++` should not be used while the data transmission is paused with XOFF. Before entering the command mode with `+++` the paused transmission should be resumed using the XON character.
- For compatibility reasons, the `AT+IFC` command can be used in Multiplex mode, though the settings will not take effect. However, be aware that whenever you use the `AT+IFC` write command in Multiplex mode and then save the current configuration to the user profile with `AT&W`, the changed `AT+IFC` setting will become active after restart.

4.8 AT+ILRR Set TE-TA local rate reporting

The command [AT+ILRR](#) controls whether or not the intermediate result code "[+ILRR](#)" is transmitted from the TA to the TE while a connection is being set up. The result code indicates the local rate. It is issued before the final result code of the connection, e.g. CONNECT, is transmitted to the TE.

Syntax

<p>Test Command</p> <pre>AT+ILRR=?</pre> <p>Response(s)</p> <pre>+ILRR: (list of supported <value>s) OK</pre>	
<p>Read Command</p> <pre>AT+ILRR?</pre> <p>Response(s)</p> <pre>+ILRR: <value> OK</pre>	
<p>Write Command</p> <pre>AT+ILRR=<value></pre> <p>Response(s)</p> <pre>OK ERROR +CME ERROR</pre>	
<p>Reference(s)</p> <pre>V.250</pre>	

Intermediate Result Code

[+ILRR](#): [<rate>](#)

Indicates local port rate setting upon connection setup.

Parameter Description

<value> ^{(num)(&W)(&V)}	
0(&F)	Disables reporting of local port rate
1	Enables reporting of local port rate

<rate> ^(num)	
0	Autobauding (see Section 4.9.1, Autobauding). Not supported on ASC1. Not usable with Java.
300	
600	
1200	
2400	
4800	
9600	

14400
19200
28800
38400
57600
115200
230400
460800

4.9 AT+IPR Set fixed local rate

The command [AT+IPR](#) can be used to set or query the TE-TA interface bit rate.

Syntax

<p>Test Command</p> <pre>AT+IPR=?</pre> <p>Response(s)</p> <pre>+IPR: (list of supported auto-detectable <rate>s) , (list of supported fixed-only <rate>s) OK</pre>	
<p>Read Command</p> <pre>AT+IPR?</pre> <p>Response(s)</p> <pre>+IPR: <rate> OK</pre>	
<p>Write Command</p> <pre>AT+IPR=<rate></pre> <p>Response(s)</p> <pre>OK ERROR +CME ERROR</pre>	
<p>Reference(s)</p> <p>V.250</p>	

Command Description

The test command returns the values of the supported automatically detectable bit rates and the values of the supported fixed bit rates.

The read command returns the current bit rate of the interface.

The write command specifies the bit rate to be used for the interface. When you set a fixed-rate, make sure that both TE (DTE) and TA (DCE) are configured to the same rate. When you select autobauding, the TA will automatically recognize the bit rate currently used by the TE.

The setting is stored in the non-volatile memory and will be used whenever the engine is powered up again. However, in case of autobaud mode ([AT+IPR=0](#)) the detected TA bit rate will not be saved and, therefore, needs to be resynchronized after restarting the GSM engine (see Section [4.9.1, Autobauding](#)).

Parameter Description

<code><rate></code> ^{(num)(&V)}	
bit rate per second (bps)	
0 ^(D)	Activates autobauding. Not supported on ASC1. Not usable with Java. See Section 4.9.1, Autobauding for further details.
300	
600	
1200	
2400	
4800	
9600	

14400
19200
28800
38400
57600
115200
230400
460800

Notes

- Factory default is autobauding enabled ([AT+IPR=0](#)) on ASC0 and 57600bps on ASC1. It will not be restored with [AT&F](#).
- The current setting of [AT+IPR](#) will be preserved when you download firmware (i.e. a firmware update does not restore the factory setting) or in the event of power failure.
- Generally, [AT+IPR](#) should be used as a standalone command. If nevertheless combinations with other commands on the same command line cannot be avoided, there are several constraints to be considered:
 - Avoid combinations with the AT commands listed in Section 1.4.2, [Combining AT commands on the same command line](#).
 - Take into account, that a delay of 100ms is required between the response to the last command (e.g. OK) and the next command on the same line.
 - When you enter [AT+IPR=0](#), autobauding will be activated after the response to the last command is received.
 - When local echo is active ([ATE1](#)) and you enter [AT+IPR=x](#) with other commands you may encounter the following problem: if switching to the new bit rate takes effect while a response is being transmitted, the last bytes may be sent with the new bit rate and thus, not properly transmitted. The following commands will be correctly sent at the new bit rate.
- In order to account for greater amounts of data it is recommended to choose a minimum bit rate of 2400 bps. If the ME is operated in Multiplex mode we suggest a minimum bit rate of 4800bps.
- A selected bit rate takes effect after the write commands returns OK (except for Multiplex mode).
- In Multiplex mode, the write command [AT+IPR=<rate>](#) will not change the bit rate currently used, but the new bit rate will be stored and becomes active, when the module is restarted.
- If Java is running, the firmware will ignore any settings made with [AT+IPR](#). Responses to the read, write or test command will be invalid or deliver "ERROR". See also "TC65 Java User's Guide" [3], Section "Configuring serial interface".

4.9.1 Autobauding

To take advantage of autobaud mode specific attention must be paid to the following requirements:

- Synchronization between TE and TA
Ensure that TE and TA are correctly synchronized and the bit rate used by the TE is detected by the TA. To allow the bit rate to be synchronized simply use an "AT" or "at" string. This is necessary
 - after you have activated autobauding
 - when you start up the GSM engine while autobauding is enabled. It is recommended to wait 3 to 5 seconds before sending the first AT character. Otherwise undefined characters might be returned.

If you want to use autobauding and autoanswer at the same time, you can easily enable the TE-TA synchronization, when you activate autobauding first and then configure the autoanswer mode ([ATS0](#) ≠ 0).
- Restrictions on autobauding operation
 - The serial interface shall be used with 8 data bits, no parity and 1 stop bit (factory setting), e.g. 2 stop bits are not supported for autobaud mode.

- The command [A/](#) cannot be used.
 - Only the strings "AT" or "at" can be detected (neither "At" nor "aT").
 - The second serial interface ASC1 does not support autobauding.
 - If autobauding is enabled you cannot activate multiplex mode, see [AT+CMUX](#).
 - Autobauding cannot be used if the ME operates with Java
 - URCs that may be issued before the ME detects a new bit rate (by receiving the first AT character) will be sent at the previously detected bit rate or, after ME restart, at 57600 bps.
 - It is not recommended to switch to autobauding from a bit rate that cannot be detected by the the autobaud mechanism (e.g. 300 bps). Responses to [AT+IPR=0](#) and any commands on the same line might be corrupted.
 - When autobauding is switched on:
 - + only data length, parity and baud rate are automatically detected
 - + if using 1 stop bit, [AT+ICF=1](#) should not be used, because it uses 2 stop bits
 - + if using 2 stop bits, no combination of [AT+ICF](#) should be used, which uses 1 stop bit
 - Autobauding and bit rate after restart
The most recently detected bit rate is stored when the ME is powered down (with [AT^SMSO](#)). Therefore, each time the module is restarted the correct bit rate must be found as described above. Unless the bit rate is determined, the following constraints apply:
 - An incoming CSD call or a network initiated GPRS request cannot be accepted. This must be taken into account when autobauding and autoanswer mode ([ATS0 ≠ 0](#)) are enabled at the same time, especially if SIM PIN 1 authentication is done automatically and the setting [ATS0 ≠ 0](#) is stored to the user profile with [AT&W](#).
 - Until the bit rate is found, URCs generated after restart will be output at 57600 bps. This applies only to user defined URCs, such as "+CREG", "CCWA", "^SCKS" etc. The URCs "^SYSSTART", "^SYSSTART CHARGE-ONLY MODE" and "^SYSSTART AIRPLANE MODE" will not be indicated when autobauding is enabled.
- Note: To avoid any problems caused by undetermined bit rates in the direction from TA to TE we strongly recommend to configure a fixed bit rate rather than autobauding.
- Autobauding and multiplex mode
If autobauding is active you cannot switch to multiplex mode (see [AT+CMUX](#)).

4.10 AT+CMUX Enter multiplex mode

All information provided in this section applies to the ASC0 interface only. The second interface ASC1 has no support of Multiplex mode.

Multiplex mode according to the ETSI TS 101 669 and GSM 07.10 enables one physical serial asynchronous interface to be partitioned into three virtual channels. This allows you to take advantage of up to 3 simultaneous sessions running on the serial interface. For example, you can send or receive data or make a call on the first channel, while the other two channels are free to control the module with AT commands.

The TC65 module incorporates an internal multiplexer and thus integrates all the functions needed to implement full-featured multiplex solutions. For the application on top, customers have the flexibility to create their own multiplex programs conforming to the multiplexer protocol. To help system integrators save the time and expense of designing multiplexer applications, SIEMENS AG offers WinMUX2k, a ready-to-use multiplex driver for Windows 2000 and Windows XP. Another approach is to develop customized solutions based on the sources of the WinMux2k driver.

Refer to [6] which provides a detailed description of the multiplex architecture and step-by-step instructions of how to install and configure the multiplex mode. The WinMUX2k driver and its source files can be supplied on request. Please contact your local distributor to obtain the latest installation software and user's guide.

Syntax

<p>Test Command</p> <p>AT+CMUX=?</p> <p>Response(s)</p> <p>+CMUX: (list of supported<mode>s)</p> <p>OK</p>																					
<p>Read Command</p> <p>AT+CMUX?</p> <p>Response(s)</p> <p>+CMUX: <mode></p> <p>OK</p> <p>ERROR</p> <p>+CME ERROR: <err></p>																					
<p>Write Command</p> <p>AT+CMUX=<mode></p> <p>Response(s)</p> <p>OK</p> <p>ERROR</p> <p>+CME ERROR: <err></p>																					
<p>Reference(s)</p> <p>GSM 07.07, GSM 07.10</p>	<table border="1"> <tr> <td>PIN</td> <td>ASC0</td> <td>ASC1</td> <td>USB</td> <td>MUX1</td> <td>MUX2</td> <td>MUX3</td> <td>Charge</td> <td>✈</td> <td>Last</td> </tr> <tr> <td><input type="radio"/></td> <td><input checked="" type="radio"/></td> <td><input type="radio"/></td> <td><input checked="" type="radio"/></td> <td><input type="radio"/></td> <td><input type="radio"/></td> <td><input type="radio"/></td> <td><input type="radio"/></td> <td><input type="radio"/></td> <td><input checked="" type="radio"/></td> </tr> </table>	PIN	ASC0	ASC1	USB	MUX1	MUX2	MUX3	Charge	✈	Last	<input type="radio"/>	<input checked="" type="radio"/>	<input type="radio"/>	<input checked="" type="radio"/>	<input type="radio"/>	<input type="radio"/>	<input type="radio"/>	<input type="radio"/>	<input type="radio"/>	<input checked="" type="radio"/>
PIN	ASC0	ASC1	USB	MUX1	MUX2	MUX3	Charge	✈	Last												
<input type="radio"/>	<input checked="" type="radio"/>	<input type="radio"/>	<input checked="" type="radio"/>	<input type="radio"/>	<input type="radio"/>	<input type="radio"/>	<input type="radio"/>	<input type="radio"/>	<input checked="" type="radio"/>												

Parameter Description

<mode> ^(num)	
Multiplexer transparency mechanism	
0	Basic option
<subset> ^(num)	
Subparameters defined in GSM07.07 are adjusted for control and logical channels as follows	
0	UIH frames used only (control channel)

Notes

- The write command is used to enter the multiplex mode. The setup of the logical channels is initiated by the TE, i.e. the TE acts as initiator. This means that the TE shall ensure that logical channels are established before any further actions on the channels can be started.
- There is a timeout of five seconds, if the multiplexer protocol is enabled and no multiplexer control channel is established. The GSM engine returns to AT command mode.
- The parameter maximum frame size (N1) of [AT+CMUX](#) in GSM 07.10 is fixed to 98 bytes and cannot be changed. All other parameters are not available.
- If the ME is Java controlled the multiplexer mode is handled by the Java application. Therefore, the [AT+CMUX](#) write command returns "ERROR" if used from Java.
- If Java autostart is enabled with [AT^SCFG](#), it is not possible to activate Multiplex mode on ASC0.
- Multiplexer mode requires character framing to be set to 8 bits, no parity and 1 stop bit. The setting can be made using ([AT+ICF=3](#)).

4.10.1 Restrictions on Multiplex mode

When the serial interface ASC0 is in multiplex mode, data and fax calls can only be set up on logical channel 1. Due to this restriction, AT commands have a different behavior on channels 2+3 compared to channel 1. Several commands are not available, others return different responses. This section summarizes the concerned commands. For general rules and restrictions to be considered in Multiplex mode please refer to [\[6\]](#).

Table 4.1: Availability of AT Commands on Virtual Channels

Command	Behavior on channel 1	Behavior on channel 2+3
+++	not usable, but see note ²⁾	not usable, but see note ²⁾
AT+CBST	as described	not usable
AT+CRLP	as described	not usable
AT+CG... (GPRS commands)	as described	see note ³⁾
AT+F... (Fax commands)	as described	not usable
AT&S	as described	not usable
ATA	as described	no Data Calls
ATD	as described	no Data Calls
ATDI	as described	not usable
ATL	as described	not usable
ATM	as described	not usable
ATO	as described	not usable
ATS6 ¹⁾	as described	not usable
ATS7 ¹⁾	as described	not usable
ATS8 ¹⁾	as described	not usable
ATS10 ¹⁾	as described	not usable
ATS18 ¹⁾	as described	not usable

- 1) Siemens GSM engines support the registers S0 - S29. You can change S0,S3,S4,S5,S6,S7,S8,S10 and S18 using the related ATSn commands (see starting from [ATS0](#)). The other registers are read-only and for internal use only!
- 2) The applicability of the +++ escape sequence depends on the customer's external application based on the Multiplexer Protocol. Recommendations for implementing an appropriate modem status command (MSC) are provided in [\[6\]](#), Section "Escape Sequence".
- 3) PDP contexts can be defined on any channel, but are visible and usable only on the channel on which they are defined (thus it is not possible to define a context on channel 2 and activate it on channel 3). GPRS connections can be estab-

lished on two channels at a time.

Table 4.2: Summary of AT commands with Different Behavior in Multiplex Mode

Command	Description
AT\Q	It is recommended to use hardware flow control (AT\Q3). XON/XOFF flow control (AT\Q1) is not supported in Multiplex mode. See note regarding AT\Qn settings stored with AT&W if Multiplex mode is active.
AT&V	Different default configurations on channels 1, 2 and 3.
AT&W	Different user profiles can be stored on each channel.
AT+IPR	Before you start Multiplex mode, it is recommended to set the ME to 57600 bps (minimum should be 4800 bps). For GPRS we suggest to use 115200 bps or 230400 bps. In Multiplex mode, the write command AT+IPR=<rate> will not change the bit rate currently used, but the new bit rate will be stored and becomes active, when the module is restarted.
AT+IPR=0	Multiplex mode cannot be activated while autobauding is enabled.
AT+CALA	On each channel an individual <text> message can be stored. but only one time setting applies to all channels. This means an alarm <time> set on one of the channels overwrites the time setting on all remaining channels. Therefore, the total number of alarm events returned by the read command AT+CALA? will always be <n>=0, no matter whether individual text messages are stored. When the alarm is timed out and executed the ME sends the URC only on the channel where the most recent alarm setting was made. The alarm time will be reset to "00/01/01,00:00:00" on all channels.
AT+CMEE	Presentation mode can be separately configured for each channel.
AT+CNMA	If Multiplex mode is activated the +CNMI parameter will be set to zero on all channels, if one channel fails to acknowledge an incoming message within the required time.
AT+CNMI	Phase 2+ parameters can only be used on one channel. The parameter for <mt> and <ds> on the other channels have to be set to zero. If either a SM or a Status Report is not acknowledged, all +CNMI parameter will be set to zero on all channels.
AT+CFUN	If the ME is in Multiplexer mode, it is not recommended to activate SLEEP mode with AT+CFUN=<fun>. The best approach to properly control SLEEP mode in this case is to issue the PSC messages described in [6], Section "Power saving control (PSC)".
AT+CPMS	Parameter <mem3> will be the same on all instances, but the settings of <mem1> and <mem2> may vary on each instance.
AT^SSDA	If one instance is set to <da>=1 and <mt>=1, then all other instances must be configured for <mt>=0.

4.10.2 Second serial interface ASC1

The second serial interface ASC1 is intended as an auxiliary interface for applications which need multiple parallel access to the module (e.g. to query status information during a data call), but cannot use the GSM 07.10 multiplexing protocol. Therefore this interface offers limited functionality only.

- No DTR, DSR, DCD, RING signals. These hardware lines do not exist. As a result, AT commands controlling the behavior of these lines ([AT&D](#), [AT&C](#), [AT&S](#)) are not allowed and return ERROR.
- No presentation of ^SYSSTART URCs on ASC1. After restart or reset of the ME, either check that the URC has been sent on ASC0 or wait approximately 3 seconds before entering the first AT command on ASC1.
- No Autobauding. The hardware is not capable of automatically detecting the baudrate on this interface, so the AT command which selects autobauding ([AT+IPR=0](#)) is not allowed and returns ERROR.
- No CSD calls, so all related AT commands cannot be used and return ERROR.
- No fax calls, so all AT+F commands cannot be used and return ERROR.
- No GSM 07.10 Multiplexer. If issued on the second interface [AT+CMUX=0](#) returns ERROR.

ASC1 is disabled when the multiplexer is enabled on the first serial interface ASC0. Yet, both ASC1 and the multiplexer channel 2 are using the same parameters, and thus, the same user defined profile (if any). As a result, a user profile stored on multiplexer channel 2 takes effect on ASC1 after closing the multiplexer and starting up ASC1. Likewise, a user profile stored on ASC1 will be loaded on multiplexer channel 2.

This may be a problem when ASC1 is not connected, but flow control (for example [AT\Q1](#) or [AT\Q3](#)) is stored to the user profile on the multiplexer channel 2. In this case, flow control takes effect on ASC1, when the multiplexer is switched off. If then for example a large amount of URCs is generated, their transmission might be stopped due to the flow control. To avoid this problem we recommend that you do not activate flow control on multiplexer channel 2 when you set up a user profile with [AT&W](#).

4.11 AT^STPB Transmit Parity Bit (for 7E1 and 7O1 only)

This command is intended only for use with 7E1 and 7O1. In addition to the 7E1 or 7O1 settings made with [AT+ICF](#) the command [AT^STPB](#) specifies whether or not to transmit the parity bit over the air.

Syntax

<p>Test Command</p> <p>AT^STPB=?</p> <p>Response(s)</p> <p>^STPB: (list of supported <n>s)</p> <p>OK</p>	
<p>Read Command</p> <p>AT^STPB?</p> <p>Response(s)</p> <p>^STPB: <n></p> <p>OK</p>	
<p>Write Command</p> <p>AT^STPB=<n></p> <p>Response(s)</p> <p>OK</p> <p>ERROR</p> <p>+CME ERROR: unknown</p>	
<p>Reference(s)</p> <p>SIEMENS</p>	<p>PIN ASC0 ASC1 USB MUX1 MUX2 MUX3 Charge → Last</p> <p><input type="radio"/> <input checked="" type="radio"/> <input type="radio"/> <input checked="" type="radio"/> <input checked="" type="radio"/> <input type="radio"/> <input type="radio"/> <input type="radio"/> <input checked="" type="radio"/> <input type="radio"/></p>

Command Description

The test command returns the supported values of the parameter <n>.

The read command returns the current value of the parameter <n>.

The write command can be used to control the handling of the parity bit. If command fails, "+CME ERROR: unknown" will be returned.

Parameter Description

<n> ^{(num)&W}	
0(&F)	The parity bit will not be transmitted over the air and will be replaced with 0. This mode is the default setting if 7E1 or 7O1 is activated with AT+ICF .
1	In a data connection 8 bits will be transmitted, including the parity bit, i.e. the parity bit will be properly transmitted over the air. The setting shall be used if problems are encountered when TC65 is running in the default 7E1 or 7O1 mode enabled with AT+ICF . In this case, AT^STPB=1 shall be set in addition to the 7E1 or 7O1 settings selected with AT+ICF .

5. Security Commands

The AT Commands described in this chapter allow the external application to determine various security related settings.

5.1 AT+CPIN PIN Authentication

AT+CPIN controls network authentication of the TC65.

The read command returns an alphanumeric string indicating whether or not network authentication is required. The write command allows the TC65 to store the entered password. This may be for example the SIM PIN1 to register to the GSM network, or the SIM PUK1 to replace a disabled SIM PIN1 with a new one, or the PH-SIM PIN if the client has taken precautions for preventing damage in the event of loss or theft etc. If no PIN1 request is pending (for example if PIN1 authentication has been done and the same PIN1 is entered again) TC65 responds "+CME ERROR: operation not allowed"; no further action is required.

Syntax

<p>Test Command</p> <pre>AT+CPIN=?</pre> <p>Response(s)</p> <pre>OK</pre>	
<p>Read Command</p> <pre>AT+CPIN?</pre> <p>Response(s)</p> <pre>+CPIN: <code> OK ERROR +CME ERROR: <err></pre>	
<p>Write Command</p> <pre>AT+CPIN=<pin>[, <new pin>]</pre> <p>Response(s)</p> <pre>OK ERROR +CME ERROR: <err></pre>	
<p>Reference(s)</p> <pre>GSM 07.07</pre>	

Parameter Description

<pin>^(str)

Password (string type), usually SIM PIN1.

If the requested password was a PUK, such as SIM PUK1 or PH-FSIM PUK or another password, then **<pin>** must be followed by **<new pin>**.

<new pin>^(text)

If the requested code was a PUK: specify a new password or restore the former disabled password. See Section 5.1.1, [What to do if PIN or password authentication fails?](#) for more information about when you may need to enter the PUK.

<code>^(text)

SIM PIN authentication

READY	PIN has already been entered. No further entry needed.
SIM PIN	ME is waiting for SIM PIN1.
SIM PUK	ME is waiting for SIM PUK1 if PIN1 was disabled after three failed attempts to enter PIN1.
SIM PIN2	ME is waiting for PIN2. This is only applicable when an attempt to access a PIN2 related feature was acknowledged with +CME ERROR: 17 ("SIM PIN2 required"), for example when the client attempts to edit the FD phonebook). In this case the read command AT+CPIN? also prompts for SIM PIN2. Normally, the AT+CPIN2 command is intended for SIM PIN2.
SIM PUK2	ME is waiting for PUK2 to unblock a disabled PIN2. As above, this is only necessary when the preceding command was acknowledged with +CME ERROR: 18 ("SIM PUK2 required") and only if the read command AT+CPIN? also prompts for SIM PUK2. Normally, the AT+CPIN2 command is intended for SIM PUK2.
Phone security locks set by client or factory	
PH-SIM PIN	ME is waiting for phone-to-SIM card password if "PS" lock is active and the client inserts other SIM card than the one used for the lock. ("PS" lock is also referred to as phone or antitheft lock).
PH-SIM PUK	ME is waiting for Master Phone Code, if the above "PS" lock password was incorrectly entered three times.
PH-FSIM PIN	ME is waiting for phone-to-very-first-SIM card. Necessary when "PF" lock was set. When powered up the first time, ME locks itself to the first SIM card put into the card holder. As a result, operation of the mobile is restricted to this one SIM card (unless the PH-FSIM PUK is used as described below).
PH-FSIM PUK	ME is waiting for phone-to-very-first-SIM card unblocking password to be given. Necessary when "PF" lock is active and other than first SIM card is inserted.
PH-NET PUK	ME is waiting for network personalisation unblocking password
PH-NS PIN	ME is waiting for network subset personalisation password
PH-NS PUK	ME is waiting for network subset unblocking password
PH-SP PIN	ME is waiting for service provider personalisation password
PH-SP PUK	ME is waiting for service provider personalisation unblocking password
PH-C PIN	ME is waiting for corporate personalisation password
PH-C PUK	ME is waiting for corporate personalisation un-blocking password

Notes

- Caution: After entering a password with [AT+CPIN](#) all other commands that need access to data on the SIM card may be blocked for up to 20 seconds!
- Successful PIN authentication only confirms that the entered PIN was recognized and correct. The output of the result code OK does not necessarily imply that the mobile is registered to the desired network. Typical example: PIN was entered and accepted with OK, but the ME fails to register to the network. This may be due to missing network coverage, denied network access with currently used SIM card, no valid roaming agreement between home network and currently available operators etc. ME offers various options to verify the present status of network registration: For example, the [AT+COPS](#) command indicates the currently used network. With [AT+CREG](#) you can also check the current status and activate an unsolicited result code which appears whenever the status of the network registration changes (e.g. when the ME is powered up, or when the network cell changes).
- Wait 10 seconds after PIN input before using SMS related commands.

- `<pin>` and `<new pin>` can also be entered in quotation marks (e.g. "1234").
- To check the number of remaining attempts to enter the passwords use the `AT^SPIC` command.
- See `AT+CPWD` and `AT^SPWD` for information on passwords.
- See `AT+CLCK` and `AT^SLCK` for information on lock types.

5.1.1 What to do if PIN or password authentication fails?

PIN1 / PUK1:

After three failures to enter PIN 1, the SIM card is blocked (except for emergency calls). +CME ERROR: 12 will prompt the client to unblock the SIM card by entering the associated PUK (= PIN Unblocking Key / Personal Unblocking Key). After ten failed attempts to enter the PUK, the SIM card will be invalidated and no longer operable. In such a case, the card needs to be replaced. PIN1 consists of 4 to 8 digits, PUK1 is an 8-digit code only. To unblock a disabled PIN1 you have two options:

- You can enter `AT+CPIN=PUK1,new PIN1`.
- You can use the `ATD` command followed by the GSM code `**05*PUK*newPIN*newPIN#;`.

PIN2 / PUK2:

PIN2 prevents unauthorized access to the features listed in `AT+CPIN2`. The handling of PIN2 varies with the provider. PIN2 may either be a specific code supplied along with an associated PUK2, or a default code such as 0000. In either case, the client is advised to replace it with an individual code. Incorrect input of PUK2 will permanently block the additional features subject to PIN2 authentication, but usually has no effect on PIN1. PIN2 consists of 4 digits, PUK2 is an 8-digit code only.

To unblock a disabled PIN2 you have two options:

- You can enter `AT+CPIN2=PUK2,new PIN2`.
- You can use the `ATD` command followed by the GSM code `**052*PUK2*newPIN2*newPIN2#;`.

Phone lock:

If the mobile was locked to a specific SIM card (= "PS" lock or phone lock), the PUK that came with the SIM card cannot be used to remove the lock. After three failed attempts to enter the correct password, ME returns +CPIN: PH-SIM PUK (= response to read command `AT+CPIN?`), i.e. it is now waiting for the Master Phone Code. This is an 8-digit device code associated to the IMEI number of the mobile which can only be obtained from the manufacturer or provider. When needed, contact Siemens AG and request the Master Phone Code of the specific module.

There are two ways to enter the Master Phone code:

- You can enter `AT+CPIN=Master Phone Code`
- You can use the `ATD` command followed by the GSM code `*#0003*Master Phone Code#;`.

Usually, the Master Phone Code will be supplied by mail or e-mail. If the received number is enclosed in the *# codes typically used for the `ATD` option, it is important to crop the preceding *#0003* characters and the appended #.

Example: You may be given the string `*#0003*12345678#`. When prompted for the PH-SIM PUK simply enter 12345678.

If incorrectly input, the Master Phone Code is governed by a specific timing algorithm: $(n-1) * 256$ seconds (see table below). The timing should be considered by system integrators when designing an individual MMI.

Number of failed attempts	Time to wait before next input is allowed
1st failed attempt	No time to wait
2nd failed attempt	4 seconds
3rd failed attempt	3 * 256 seconds
4th failed attempt	4 * 256 seconds
5th failed attempt	5 * 256 seconds
6th failed attempt and so forth	6 * 256 seconds and so forth

SIM locks:

These are factory set locks, such as "PF", "PN", "PU", "PP", "PC". An 8-digit unlocking code is required to operate the mobile with a different SIM card, or to lift the lock. The code can only be obtained from the provider. Failure to enter the password is subject to the same timing algorithm as the Master Phone Code (see Table above).

Call barring:

Supported modes are "AO", "OI", "OX", "AI", "IR", "AB", "AG", "AC". If the call barring password is entered incorrectly three times, the client will need to contact the service provider to obtain a new one.

Related sections:

"`+CME ERROR: <err>`" values are specified at Section [2.12.1, CME/CMS Error Code Overview](#). For further instructions and examples see [AT+CLCK](#), [AT^SLCK](#), [AT+CPWD](#) and [AT^SPWD](#).

For a complete list of Star-Hash codes please refer Section [22.2, Star-Hash \(*#\) Network Commands](#).

5.2 AT+CPIN2 PIN2 Authentication

[AT+CPIN2](#) controls network authentication of the TC65.

The read command returns an alphanumeric string indicating whether or not network authentication is required. The write command allows the TC65 to store the entered password. This may be for example the SIM PIN2 to benefit from the features listed below, or the SIM PUK2 to replace a disabled PIN2 with a new one. Note that PIN2 can only be entered if PIN1 authentication was done.

If the TC65 is requesting SIM PUK2, use `<pin>` to enter the PUK2, followed by `<new pin>` to specify the new PIN2.

Syntax

<p>Test Command</p> <pre>AT+CPIN2=?</pre> <p>Response(s)</p> <pre>OK</pre>	
<p>Read Command</p> <pre>AT+CPIN2?</pre> <p>Response(s)</p> <pre>+CPIN2: <code> OK ERROR +CME ERROR: <err></pre>	
<p>Write Command</p> <pre>AT+CPIN2=<pin>[, <new pin>]</pre> <p>Response(s)</p> <pre>OK ERROR +CME ERROR: <err></pre>	
<p>Reference(s)</p> <pre>GSM 07.07</pre>	

Parameter Description

<code><pin></code> ^(str)	Password (string type), usually SIM PIN2 or, if requested, SIM PUK2.
<code><new pin></code> ^(str)	If the requested code was SIM PUK2: new password (PIN2). See Section 5.1.1, What to do if PIN or password authentication fails? for more information about when you may need to enter the PUK.
<code><code></code> ^(text)	
READY	ME is not pending for any password.
SIM PIN2	ME is waiting for SIM PIN2. This <code><code></code> is returned only when PIN2 authentication has not yet been done or has failed ("+CME ERROR:17").
SIM PUK2	ME is waiting for SIM PUK2. This <code><code></code> is returned only when PIN2 authentication has failed and ME is pending for SIM PUK2 (i.e. "+CME ERROR:18").

Note

- Functions accessible only after PIN2 authentication:
[AT+CACM](#): Accumulated call meter (ACM) reset or query
[AT+CAMM](#): Accumulated call meter maximum (ACMmax) set or query
[AT+CLCK](#): Facility lock to "FD" (Fixed dialing phonebook)
[AT^SLCK](#): Facility lock to "FD" (Fixed dialing phonebook)
[AT+CPWD](#): Change "P2"password
[AT^SPWD](#): Change "P2"password
[AT+CPUC](#): Price per unit and currency table
[AT+CPIN2](#): Enter SIM PIN2 or SIM PUK2 if requested.

For example, SIM PIN2 will be needed when you attempt to edit the "FD" phonebook and ME returns "+CME Error 17" or "+CPIN: SIM PIN2".

Once the required `<pin>` has been entered correctly, PIN2 authentication code changes to READY. After 300s, a repetition of the authentication process is required (PIN2 authentication code changes from READY to SIM PIN2).

Examples

EXAMPLE 1

Change PIN2

```
AT+CPWD="P2","0000","8888" (where "0000" = old PIN2 and "8888" = new PIN2)
OK
```

EXAMPLE 2

Unblock a disabled PIN2

```
AT+CPIN2?
+CPIN2: SIM PUK2
OK
AT+CPIN2=12345678,8888
PIN2 has been disabled, PUK2 must be entered
to define a new PIN2
where "12345678" is the PUK2, and "8888" the new
PIN2.
```

EXAMPLE 3

Write into "FD" phonebook

```
AT+CPBS="FD"
OK
AT+CPBW=2,"+493012345678",145,"Charly"
+CME ERROR 17
AT+CPIN2=8888
OK
AT+CPBW=2,"+493012345678",145,"Charly"
OK
access denied due to missing PIN2 authentication
```

5.3 AT^SPIC Display PIN counter

The `AT^SPIC` command can be used to find out whether the ME is waiting for a password and, if so, how many attempts are left to enter the password.

The execute command returns the number of attempts still available for entering the currently required password, for example the PIN, PUK, PH-SIM PUK etc.

The read command `AT^SPIC?` indicates which password the number of attempts stated by the execute command actually refers to. Also, the write command may be used to query the counter for a specific password: It indicates the number of attempts still available for entering the password identified by `<facility>`, for example the PIN, PIN2, PH-SIM PIN etc.

To check whether or not you need to enter a password use the read commands `AT+CPIN?`, `AT+CPIN2?` and `AT^SPIC?`. If the response to `AT+CPIN?` is "READY" the counter of the execute command `AT^SPIC` relates to PIN2. See [last example](#). If the responses to `AT+CPIN?` and `AT+CPIN2?` both read "READY", no password is currently required, and the referrer of the execute command `AT^SPIC` is explicitly undefined.

Syntax

Test Command																					
AT^SPIC=?																					
Response(s)																					
OK																					
Read Command																					
AT^SPIC?																					
Response(s)																					
^SPIC: <code><code></code>																					
OK																					
Exec Command																					
AT^SPIC																					
Response(s)																					
^SPIC: <code><counter></code>																					
OK																					
Write Command																					
AT^SPIC= <code><facility></code>																					
Response(s)																					
^SPIC: <code><counter></code>																					
OK																					
Reference(s)																					
SIEMENS																					
	<table border="1"> <thead> <tr> <th>PIN</th> <th>ASC0</th> <th>ASC1</th> <th>USB</th> <th>MUX1</th> <th>MUX2</th> <th>MUX3</th> <th>Charge</th> <th>→</th> <th>Last</th> </tr> </thead> <tbody> <tr> <td><input type="radio"/></td> <td><input checked="" type="radio"/></td> <td><input checked="" type="radio"/></td> <td><input checked="" type="radio"/></td> <td><input checked="" type="radio"/></td> <td><input checked="" type="radio"/></td> <td><input checked="" type="radio"/></td> <td><input type="radio"/></td> <td><input checked="" type="radio"/></td> <td><input type="radio"/></td> </tr> </tbody> </table>	PIN	ASC0	ASC1	USB	MUX1	MUX2	MUX3	Charge	→	Last	<input type="radio"/>	<input checked="" type="radio"/>	<input checked="" type="radio"/>	<input checked="" type="radio"/>	<input checked="" type="radio"/>	<input checked="" type="radio"/>	<input checked="" type="radio"/>	<input type="radio"/>	<input checked="" type="radio"/>	<input type="radio"/>
PIN	ASC0	ASC1	USB	MUX1	MUX2	MUX3	Charge	→	Last												
<input type="radio"/>	<input checked="" type="radio"/>	<input checked="" type="radio"/>	<input checked="" type="radio"/>	<input checked="" type="radio"/>	<input checked="" type="radio"/>	<input checked="" type="radio"/>	<input type="radio"/>	<input checked="" type="radio"/>	<input type="radio"/>												

Parameter Description

`<counter>`^(num)

Number of attempts left to enter the currently required password. This number will be counted down after each failure.

<facility>^(str)

Password for which the corresponding PIN counter is to be displayed.

"SC"	SIM PIN or SIM PUK. If the SIM PIN has been deactivated after three failed attempts, the counter for SIM PUK will be returned instead.
"PS"	"Phone code" or "device code" (cf. AT+CLCK and AT+CPWD). If incorrectly entered three times, the Master Phone Code is required to lift the lock and the number of remaining attempts for the master phonecode will be returned.
"P2"	SIM PIN2 or SIM PUK2. If the SIM PIN2 has been deactivated after three failed attempts, the counter for SIM PUK2 will be returned instead.
"PN"	Network Personalisation

<code>^(text)

Identification of the currently required password.

SIM PIN	ME is waiting for SIM PIN1.
SIM PUK	ME is waiting for SIM PUK1 if PIN1 was disabled after three failed attempts to enter PIN1.
SIM PIN2	ME is waiting for PIN2, when the attempt to access PIN2 requiring features was acknowledged with +CME ERROR:17 (e.g. if the user attempts to edit the FD phonebook).
SIM PUK2	ME is waiting for PUK2 to unblock a disabled PIN2. Necessary if preceding command was acknowledged with +CME ERROR:18.
PH-SIM PIN	ME is waiting for phone-to-SIM card password if "PS" lock is active and user inserts other SIM card than the one used for the lock. ("PS" lock is also referred to as phone or antitheft lock).
PH-SIM PUK	ME is waiting for Master Phone Code, if the above "PS" lock password was incorrectly entered three times.
PH-NET PUK	ME is waiting for network personalisation unblocking password

Notes

- Whenever the required password changes, <counter> changes to reflect that change. Please refer to the examples below.
- For passwords associated to the phone lock ("PS" lock set by user or factory) or other factory set locks, such as "PF", "PN", "PU", "PP", "PC" the number of attempts is subject to a timing algorithm explained in [AT+CPIN](#). If these passwords are incorrectly entered the counter first returns 3, 2 and 1 remaining attempt(s), but then gives the total number of attempts which amounts to 63 (see example below).
- See also Chapters [AT+CLCK](#), [AT+CPIN](#), [AT+CPIN2](#), [AT+CPWD](#), [AT^SLCK](#) for further information on locks and passwords.

Examples

EXAMPLE 1

The user fails to provide a correct SIM PIN three times. The counter decreases each time. After the counter reaches zero, the SIM PUK is required. After each failure to enter a correct SIM PUK, the counter decreases.

```
at+cpin?
+CPIN: SIM PIN
OK
at^spic
^SPIC: 3
OK
at+cpin=9999
+CME ERROR: incorrect password
```

Currently required password is PIN1.

3 attempts left.

```

at^spic
^SPIC: 2                                2 attempts left.
OK
at+cpin=9999
+CME ERROR: incorrect password
OK
at^spic
^SPIC: 1                                1 attempt left.
OK
at+cpin=9999
+CME ERROR: incorrect password
at+cpin?
+CPIN: SIM PUK
OK                                        Now required password is PUK 1.
at^spic
^SPIC: 10                               10 attempts left for PUK 1.
OK
at+cpin=01234567,1234
+CME ERROR: incorrect password
at^spic
^SPIC: 9                                9 attempts left for PUK 1.
OK

```

EXAMPLE 2

Though a mobile is locked to a specific SIM card (phone lock), the user attempts to operate it with another SIM card. The user correctly enters the SIM PIN of the SIM card currently inserted, but then fails to give the "PS" lock password (PH-SIM PUK):

```

at+cpin=9999
OK
at+cpin?
+CPIN: PH-SIM PIN                       ME is waiting for the phone lock password.
OK
at^spic
^SPIC: 3                                3 attempts left.
OK
at+cpin=4711
+CME ERROR: incorrect password
at^spic?
^SPIC: 2                                2 attempts left.
OK
at+cpin=4712
+CME ERROR: incorrect password
at^spic
^SPIC: 1                                1 attempt left.
OK
at^spic?
^SPIC: PH-SIM PIN                       Displayed counter refers to phone lock password.
OK

at+cpin=4713
+CME ERROR: incorrect password
at^spic
^SPIC: 63
OK
at^spic?
^SPIC: PH-SIM PUK                       Displayed counter refers to master phone code.
OK

```

```
at+cpin=4714
+CME ERROR: incorrect password
at^spic
^SPIC: 63
OK
```

EXAMPLE 3

This example shows that after successful SIM PIN1 authentication the counter of the `AT^SPIC` execute and read command refers to SIM PIN2, i.e. it does not reflect the status of SIM PIN1. This may be a problem if the user enters a wrong PIN1 and is not aware that the number of attempts left to enter SIM PIN1 is counted down.

<pre>+CREG: 0 at+cpin=1234 OK +CREG: 2 +CREG: 1 at+cpin? +CPIN: READY at^spic ^SPIC: 3 OK AT^SPIC? ^SPIC: SIM PIN2 OK at+clck="SC",0,456789 +CME ERROR: incorrect password at^spic ^SPIC: 3 at+clck="SC",0,456789 +CME ERROR: incorrect password at^spic ^SPIC: 3 at+clck="SC",0,456789 +CME ERROR: incorrect password +CREG: 0 at^spic ^SPIC: 10</pre>	<p>The mobile ist properly registered to the network.</p> <p>The <code>AT+CPIN?</code> read command confirms that SIM PIN1 authentication was successful.</p> <p>As SIM PIN1 authentication was successful, the counter relates to SIM PIN2 and correctly indicates that the user has 3 attempts to enter SIM PIN2.</p> <p>Likewise, the read command notifies that the ME is waiting for SIM PIN2.</p> <p>First attempt to enter a wrong SIM PIN1.</p> <p>SIM PIN1 authentication is still valid, and the counter relates to SIM PIN2.</p> <p>Second attempt to enter a wrong SIM PIN1.</p> <p>SIM PIN1 authentication is still valid, and the counter relates to SIM PIN2.</p> <p>Third attempt to enter a wrong SIM PIN1.</p> <p>SIM PIN1 authentication is no longer valid.</p> <p>This time, after the SIM PIN1 code has been disabled, the counter indicates the status of SIM PIN1 and notifies that 10 attempts are left to enter the SIM PUK.</p>
--	--

To avoid conflicts we recommend to use the `AT^SPIC` read and write commands rather than the execute command only. The read command clearly states the currently required password, and the write command may be used to get the counter for a specific `<facility>`, in this case for example "P2".

5.4 AT+CLCK Facility lock

AT+CLCK can be used to lock, unlock or interrogate a network or ME <facility>. The command can be aborted when network facilities are being set or interrogated.

Syntax

<p>Test Command</p> <pre>AT+CLCK=?</pre> <p>Response(s)</p> <pre>+CLCK: list of supported <facility>s OK</pre>	<p>Write Command</p> <pre>AT+CLCK=<facility>, <mode>[, <password>][, <class>]</pre> <p>Response(s)</p> <pre>if <mode> is not equal 2 and command successful: OK if <mode>= 2 and command successful: +CLCK: <status>[, <class>] [+CLCK: <status>[, <class>]] [+CLCK: ...] OK If error is related to ME functionality +CME ERROR</pre>
<p>Reference(s)</p> <pre>GSM 07.07, GSM 02.04, GSM 02.88, GSM 03.88, GSM 04.88</pre>	

Parameter Description

<facility> ^(str)	
Phone security locks set by client or factory	
Primarily intended for the client to take safety precautions, "SC", "PS" and "FD" can be configured individually. "PS" may also be factory set.	
Parameter <class> is not applicable to security locks.	
See examples below for further details.	
"SC"	SIM (lock SIM cards). SIM requests password upon ME power-up and when this lock command is issued. <password>: SIM PIN1.
"PS"	Phone locked to SIM card. ME requests password when other than current SIM card is inserted. "PS" lock is frequently referred to as "phone lock", or "device lock". Accordingly, the password may be called "phone code" or "device code". The "PS" password is not associated with the PUK of the SIM card. If incorrectly entered three times, the Master Phone Code is required to lift the lock. This is an 8-digit device code associated to the IMEI number of the mobile which can only be obtained from the manufacturer of the module. Once the Master Phone Code has been accepted, the mobile is operational, and the "PS" lock is no longer active. If needed it must be set once again.

“FD“

<password>: User defined password. It is needed before the first use of <facility> "PS" and, therefore, must first be specified with AT+CPWD or AT^SPWD, if it has not been predefined by factory settings. If set by factory (e.g. for a prepaid mobile), the password is supplied by the provider or operator.

SIM fixed dialling memory: If the mobile is locked to "FD", only the phone numbers stored to the "FD" memory can be dialled. (Capacity of FD phonebook depending on the SIM card).

<password>: SIM PIN 2.

If a lock on the SIM fixed dialling memory is active, the following applies:

- Outgoing voice, data or fax calls can be made only to numbers stored in "FD" phonebook.
Result code depends on the type of the call:
for voice calls, indication is "+CME Error 257: Call barred".
for data and fax calls, indication is "NO CARRIER".
- Access to defined Supplementary Services such as Call barring, Call waiting, Call forwarding, Call hold and Multiparty is possible only if the exact corresponding public MMI *# code for the desired service is stored in the fixed dialling number phone book, and used with ATD.
AT commands for supplementary service control are barred while "FD" lock is active.
Indication is "+CME Error 257: Call barred".
- Access to Unstructured Supplementary Services ("USSD") is possible only if the exact desired USSD string is stored in the fixed dialling number phone book, and used with ATD.
AT commands for USSD are barred while "FD" lock is active.
Indication is "+CME Error 257: Call barred".
- SMS can be sent only to phone numbers which are stored in the "fixed dialling numbers" phonebook "FD".
Indication is "+CMS Error 302: operation not allowed".
- GPRS commands can be used only if the "fixed dialling numbers" phonebook "FD" contains an entry with phone number "*99#". This single entry enables all GPRS commands, including AT commands and modem compatibility commands like "ATD*99***1#" or "ATD*98***1#".
Indication is "+CME Error 257: Call barred".

Factory defined SIM locks:

Typical examples of factory set SIM locks are prepaid phones or network locks, used to restrict the operation of a mobile to a specific provider or operator. The client should be aware that each of these lock types can only be unlocked if the associated password is available. For example, a mobile can be locked to accept only SIM cards from the respective provider, or even one single SIM card. Once a different SIM card is inserted the ME will prompt the client to enter a specific code. This is not the PUK of the SIM card, but usually an 8-digit code which needs to be requested from the provider.

The locks can only be set by the manufacturer and need to be agreed upon between the parties concerned, e.g. provider, operator, distributor etc. on the one side and the manufacturer on the other side. For details contact your local dealer or Siemens AG.

Parameter <class> is not applicable to SIM locks.

<password> and instructions for unlocking must be obtained from the network provider.

“PF“	lock Phone to the very First SIM card
“PN“	Network Personalisation
“PU“	Network subset Personalisation
“PP“	Service Provider Personalisation
“PC“	Corporate Personalisation

Supplementary Service Call Barring:

Supplementary Service "Call Barring" allows to specify conditions under which calls will be disallowed by the network.

The availability of the Supplementary Services varies with the network. To benefit from call barring the client will need to subscribe them, though a limited number of call barring types may be included in the basic tariff package.

When you attempt to set a <facility> or <class> which is not provisioned, not yet subscribed to, or not supported by the module, the setting will not take effect regardless of the response returned. The responses in these cases vary with the network (for example "OK", "+CME ERROR: Operation not allowed", "+CME ERROR: Operation not supported" etc.). To make sure check the extended error response with AT+CEER and the lock status with <mode>=2.

<password>: Network password supplied from the provider or operator. Usually there is one password which applies to all call barring options. For details contact your provider.

"AO"	BAOC (Bar All Outgoing Calls)
"OI"	BOIC (Bar Outgoing International Calls)
"OX"	BOIC-exHC (Bar Outgoing International Calls except to Home Country)
"AI"	BAIC (Bar All Incoming Calls)
"IR"	BIC-Roam (Bar Incoming Calls when Roaming outside the home country)
"AB"	All Barring services (applicable only for <mode>=0)
"AG"	All outGoing barring services (applicable only for <mode>=0)
"AC"	All inComing barring services (applicable only for <mode>=0)

<mode>^(num)

0	unlock
1	lock
2	query status

<status>^(num)

0	lock is inactive
1	lock is active

<password>^(str)

Password string used to lock and to unlock a <facility>. Length and authority for passwords depend on the <facility> in question and are therefore listed in the section on parameter <facility>. Passwords can be modified with AT+CPWD or AT^SPWD.

<class>^(num)

Integer or sum of integers each representing a class of information, i.e. a bearer service, telecommunication service or bearer service group as defined in "GSM 02.04".

1	voice
2	class 2 ("data") comprises all those individual data classes between 16 and 128, that are supported both by the network and the MS. This means, a setting made for class 2 applies to all individual data classes (if supported). In addition, you can assign a different setting to a specific class. For example, you can activate Call Forwarding for all data classes, but deactivate it for data class 64, "dedicated packet access".
4	fax
8	SMS
16	data circuit sync
32	data circuit async

64	dedicated packet access
128	dedicated PAD access
1...[7]...255	combination of some of the above classes. For example, the default setting 7 represents the sum of the integers 1, 2 and 4 (voice, data and fax). The value 255 covers all classes. If parameter "class" is omitted, the default value 7 is used.

Notes

- The **AT+CLCK** command offers the full range of **<class>** parameters according to the GSM specifications. However, when you attempt to use a service option which is not provisioned or not yet subscribed to, the setting will not take effect regardless of the response returned. The responses in these cases vary with the network (for example "OK", "Operation not allowed", "Operation not supported" etc.). To make sure check the extended error response with **AT+CEER** and the lock status with **<mode>=2**.
- The command has been implemented with the full set of **<class>** parameters according to GSM 07.07. For actual applicability of a desired Call barring service to a specific service or service group (a specific **<class>** value) please consult table A.1 of GSM 02.04.
- If an outgoing Fax or Data Call is rejected due to an active "call barring" supplementary service, the call will be terminated with result code NO CARRIER. Under the same conditions, an outgoing Voice call will be terminated with result code NO DIALTONE.
- If an invalid **<password>** is entered several times in succession, a delay incremented after each failed attempt will increase the time to wait before the input of the **<password>** is accepted. To avoid blocking the serial interface the running **AT+CLCK** command is aborted after a short timeout and returns CME ERROR 100 ("unknown"). If then the **AT+CLCK** command is issued once again execution is denied with CME ERROR 256 ("Operation temporary not allowed"). For details regarding the delay see Section 5.1.1, [What to do if PIN or password authentication fails?](#)
- If the user tries to set a lock although it is already active or, the other way round, tries to unlock an inactive lock, the response will be OK, but the **<password>** will not be checked or verified.
- In the airplane mode the write command version for the network related **<facility>** (AO, OI, OX, AI, IR, AB, AG and AC) is not supported. For remaining facilities the command is fully functional then.

Examples

EXAMPLE 1

Lock SIM card (**<facility>= "SC"**)

AT+CLCK="SC",1,"9999"	The "SC" parameter enables or disables the SIM PIN authentication (PIN 1) when you power up the GSM engine
OK	SIM card locked. As a result, SIM PIN 1 must be entered to enable ME to register to the GSM network.

AT+CLCK="SC",0,"9999"	Unlocks SIM card.
OK	When powered up, ME registers to the GSM network without requesting SIM PIN1. Note: Depending on the services offered by the provider, this feature is not supported by all SIM card types. If so, the command returns ERROR when you attempt to unlock the card.

To query the status of the SIM card lock:

AT+CLCK="SC",2	Query the status of SIM card lock.
+CLCK: 1	SIM card is locked. SIM PIN1 must be entered to enable ME to register to the GSM network.
OK	

EXAMPLE 2

Phone lock (<facility>="PS")

```
AT+CPIN?           Make sure that PIN1 authentication is valid.
OK
```

To lock the ME to the currently inserted SIM card, first specify a password for <facility> "PS":

```
AT+CPWD="PS", , "1234"   If "PS" lock has not been set before: enter new password.
OK
```

Optionally, if "PS" password was defined before, change existing password:

```
AT+CPWD="PS", "1234", "3333"  To replace existing "PS" password: Enter old and new password.
OK
```

Then, activate the Phone Lock:

```
AT+CLCK="PS", 1, "3333"     Locks the mobile to the current SIM card.
OK
```

To operate the mobile with the SIM card for which "PS" lock was activated:

```
AT+CPIN?
+CPIN: SIM PIN
OK
AT+CPIN="9999"
OK           No additional password is required for operation (SIM recognized by
            mobile).
```

To operate the mobile with other SIM card than the one used for the "PS" lock:
Enter SIM PIN of present card, followed by "PS" lock password.

```
AT+CPIN?
+CPIN: SIM PIN
OK
AT+CPIN="1111"
OK           PIN authentication accepted.
AT+CPIN?
+CPIN: PH-SIM PIN
OK           "PS" lock password is required.
AT+CPIN="3333"
OK           "PS" Lock password has been accepted. ME is fully operational now.
```

To deactivate the Phone Lock:

```
AT+CLCK="PS", 0, "3333"     Phone Lock password has to be provided again.
OK           Now the mobile can be used with any SIM card, without the need of the
            phone lock password.
```

5.5 AT^SLCK Facility lock

AT^SLCK provides the "Facility lock" function as defined for the GSM 07.07 command AT+CLCK. The command can be used to lock, unlock or interrogate a network or ME <facility>.

AT^SLCK is, in every respect, identical with AT+CLCK, except that the command syntax and response prefix is "SLCK" instead of "+CLCK". For further details please refer to AT+CLCK.

The command can be aborted when network facilities are being set or interrogated.

Syntax

Test Command

AT^SLCK=?

Response(s)

^SLCK: list of supported <facility>s

OK

Write Command

AT^SLCK=<facility>, <mode>[, <password>][, <class>]

Response(s)

if <mode> is not equal 2 and command successful:

OK

if <mode>= 2 and command successful:

^SLCK: <status>, <class>

[^SLCK: <status>, <class>]

[^SLCK: ...]

OK

If error is related to ME functionality

+CME ERROR

Reference(s)

SIEMENS, GSM 07.07, GSM 02.04,
GSM 02.88, GSM 03.88, GSM 04.88

PIN ASC0 ASC1 USB MUX1 MUX2 MUX3 Charge → Last

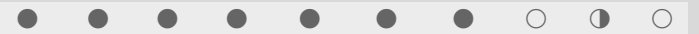

Note

- In the airplane mode the write command version for the network related <facility> (AO, OI, OX, AI, IR, AB, AG and AC) is not supported. For remaining facilities the command is fully functional then.

5.6 AT+CPWD Change Password

AT+CPWD allows to define a new password for a password protected <facility> lock function. Each password is a string of digits, the length of which varies with the associated <facility>. The test command returns a list of pairs which represent the available facilities and the maximum length of the associated password. See AT commands AT+CLCK and AT^SLCK for more information on the various lock features.

Specifically the command can be used to

- change PIN1 or PIN2,
- change the password supplied from your provider for the "call barring" supplementary service,
- set individual phone security passwords,
- enter the unblocking key (Master Phone Code) to restore a disabled "PS" password.

To delete a password use the following syntax: at+cpwd=<facility>,<old password>

Syntax

<p>Test Command</p> <pre>AT+CPWD=?</pre> <p>Response(s)</p> <pre>+CPWD: list of supported (<facility>, <password length>) OK</pre>	<p>Write Command</p> <pre>AT+CPWD=<facility>, <old password>[, <new password>]</pre> <p>Response(s)</p> <pre>New password has been registered for the facility lock function. OK If parameter <old password> was not correct: +CME ERROR 16 (+CME ERROR: incorrect password) If the password for the selected <facility> has been invalidated due to too many failed attempts: +CME ERROR ... If error is related to ME functionality: +CME ERROR</pre>
<p>Reference(s)</p> <p>GSM 07.07</p>	<p>PIN ASC0 ASC1 USB MUX1 MUX2 MUX3 Charge ↗ Last</p> <p>● ● ● ● ● ● ● ○ ● ○</p>

Parameter Description

<facility>^(str)

Phone security locks set by client or factory:

Primarily intended for the client to take safety precautions, passwords "SC" (SIM PIN) and "P2" (SIM PIN2) are usually predefined, but can be configured individually. The password for lock facility "PS" may also be factory set.

"SC"

SIM PIN. SIM requests password upon ME power-up and when this lock command is issued.

If incorrectly entered three times, the SIM PUK is required to perform authentication. Input of the SIM PUK password is possible only with AT command AT+CPIN or ATD. For further details please refer to Section 5.1.1, [What to do if PIN or password authentication fails?](#)

<password length>: 4 to 8 digits.

- “PS“
Phone locked to SIM card. ME requests password when other than current SIM card is inserted.
"PS" lock is frequently referred to as "phone lock", or "device lock". Accordingly, the password may be called "phone code" or "device code". The "PS" password is not associated with the PUK of the SIM card. It must be defined before the first use of <facility> "PS" with AT+CLCK.
<password length>: 4 digits.
If incorrectly entered three times, the Master Phone Code is required to lift the lock. This Unblocking procedure is performed with AT+CPWD using the following parameters: <facility>="PS", <old password>= Master Phone Code (to be obtained from the module manufacturer), and <new password>= the new phone code ("PS" password for lock facility), if desired.
Mind that successful PIN authentication is a prerequisite for use of AT command AT+CPWD. If Pin authentication has not been completed, input of the Master Phone code password is possible only with AT command AT+CPIN or ATD. For further detail please refer to Section 5.1.1, What to do if PIN or password authentication fails?.
Once the Master Phone Code has been accepted, the mobile is operational, and the "PS" lock is no longer active. If needed it must be set once again with AT+CLCK.
- “P2“
SIM PIN 2, e.g. required for authentication with facility lock "FD" (cf. AT+CLCK). If incorrectly entered three times, the SIM PUK 2 is required to perform authentication. Input of the SIM PUK 2 password is possible only with AT command AT+CPIN2 or ATD. For further detail please refer to Section 5.1.1, What to do if PIN or password authentication fails?.
<password length>: 4 to 8 digits.

Factory defined SIM locks:

Typical examples of factory set SIM locks are prepaid phones or network locks, used to restrict the operation of a mobile to a specific provider or operator. The client should be aware that each of these lock types can only be unlocked if the associated password is available. For example, a mobile can be locked to accept only SIM cards from the respective provider, or even one single SIM card. Once a different SIM card is inserted the ME will prompt the client to enter a specific code. This is not the PUK of the SIM card, but usually an 8-digit code which needs to be requested from the provider.

The locks can only be set by the manufacturer and need to be agreed upon between the parties concerned, e.g. provider, operator, distributor etc. on the one side and the manufacturer on the other side. For details contact your local dealer or Siemens AG.

- | | |
|------|---------------------------------------|
| “PF“ | Lock Phone to the very First SIM card |
| “PN“ | Network Personalisation |
| “PU“ | Network subset Personalisation |
| “PP“ | Service Provider Personalisation |
| “PC“ | Corporate Personalisation |

Supplementary Service Call Barring:

Supplementary Service "Call Barring" allows to specify conditions under which calls will be disallowed by the network.

The availability of the Supplementary Services varies with the network. To benefit from call barring the client will need to subscribe them, though a limited number of call barring types may be included in the basic tariff package.

<password length>: The Network Password needs to be supplied from the network provider or network operator. Usually there is one 4 digit password which applies to all call barring options. For details contact your provider.

- | | |
|------|---|
| “AO“ | BAOC (Bar All Outgoing Calls) |
| “OI“ | BOIC (Bar Outgoing International Calls) |
| “OX“ | BOIC-exHC (Bar Outgoing International Calls except to Home Country) |
| “AI“ | BAIC (Bar All Incoming Calls) |

"IR"	BIC-Roam (Bar Incoming Calls when Roaming outside the home country)
"AB"	All Barring services
"AG"	All outGoing barring services
"AC"	All inComing barring services

<password length>^(num)

4...8 Length of password. The range of permitted length for a password depends on the associated <facility>. It is available from the test command response, or in the description of parameter <facility>.

<old password>^(str)

Password specified for the facility.
Parameter <old password> can be ignored if no old password was allocated to the facility.
Take into account that a password may have already been set by factory, or that the service is subject to a password issued by the provider. See notes above or contact provider.

<new password>^(str)

New password. Mandatory, if <old password> was an unblocking key (such as the Master Phone Code).

Notes

- When changing PIN2 (<facility>="P2") it is recommended to check the new state of PIN2 by using the [AT+CPIN2](#) command.
- In the airplane mode the write command version for the network related <facility> (AO, OI, OX, AI, IR, AB, AG and AC) is not supported. For remaining facilities the command is fully functional then.

Examples

EXAMPLE 1

To change PIN2

```
AT+CPWD="P2", "0000", "8888"
OK
```

(where "0000" = old PIN2 and "8888" = new PIN2)
PIN2 Password has been changed to "8888"

EXAMPLE 2

To set password used to enable or disable barring of all outgoing calls:

```
AT+CPWD="AO", "0000", "3333"
OK
```

Requests the network to change the password for supplementary service "call barring".
Usually this request will affect all barring services, even though the request is issued for Supplementary Service BAOC ("Barring of all outgoing calls") only. Refer to the respective network provider for detail.

EXAMPLE 3

Handling of the "PS" lock password

```
AT+CMEE=2
AT+CPWD="PS", "1111", "2222"
OK
AT+CPWD="PS", "1111", "2222"
```

```
+CME ERROR: incorrect password
```

Enable text output of CME Error information (where "1111" = old password and "2222" = new password)
Password for facility "PS" is now "2222"
Repeat command to provoke error "incorrect password"
("1111" is no longer the correct password)

EXAMPLE 4

To specify a new "PS" lock password, after the old password was disabled (e.g. after three failed attempts to change the "PS" password): use the master phone code.

CAUTION: THIS TEST SHOULD BE PERFORMED ONLY IF THE CORRECT MASTER PHONE CODE FOR THE INDIVIDUAL ME USED IS DEFINITELY AVAILABLE! Otherwise the module used will be rendered useless until the correct master phone code is entered!:

```
AT+CPWD="PS", "12345678", "1111"
```

where 12345678 is the Master Phone Code and 1111 is the new password. You may also use [<new password>](#) to restore the former disabled password.

```
OK
```

Alternatively, without giving a new password:

```
AT+CPWD="PS", "12345678"
```

(where 12345678 is the Master Phone Code). Deactivates the present phone lock.

```
OK
```

5.7 AT^SPWD Change Password

The `AT^SPWD` command provides the same functions as `AT+CPWD`. The major difference between both commands is that, apart from the different prefixes "`^SPWD`" and "`+CPWD`", the `AT^SPWD` command includes one additional password dedicated to the "Customer SIM Lock". Please note that this feature is only supported by specifically pre-configured "TC65 modules and, therefore, not part of the standard "TC65 AT Command Set". Ordering information and a detailed description of the "Customer SIM Lock" feature can be requested from Siemens. All other functions and parameters of `AT^SPWD` are described in Section 5.6, `AT+CPWD`.

Each password is a string of digits the length of which varies with the associated facility. The test command returns a list of pairs which represent the available facilities and the maximum length of the associated password.

See also AT commands `AT+CLCK` and `AT^SLCK` for more information on the various lock features.

Syntax

```
Test Command
AT^SPWD=?
Response(s)
^SPWD: list of supported ( <facility>, <password length>)
OK

Write Command
AT^SPWD=<facility>, <old password>[, <new password>]
Response(s)
New password has been registered for the facility lock function.
OK
If parameter <old password> was not correct:
+CME ERROR 16 (+CME ERROR: incorrect password)
If the password for the selected <facility> has been invalidated due to too many failed attempts:
+CME ERROR ...
If error is related to ME functionality:
+CME ERROR
```

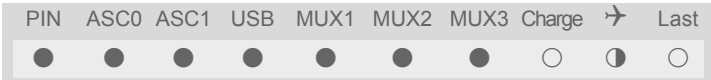

The facility lock status indicator bar shows the following facilities and their lock status:

Facility	Lock Status
PIN	Locked (●)
ASC0	Locked (●)
ASC1	Locked (●)
USB	Locked (●)
MUX1	Locked (●)
MUX2	Locked (●)
MUX3	Locked (●)
Charge	Not Locked (○)
Last	Not Locked (○)

Notes

- When changing the PIN2 (`<facility>="P2"`) it is recommended to check the new state of PIN2 using the `AT+CPIN2` command.
- In the airplane mode the write command version for the network related `<facility>` (AO, OI, OX, AI, IR, AB, AG and AC) is not supported. For remaining facilities the command is fully functional then.

6. Identification Commands

The AT Commands described in this chapter allow the external application to obtain various identification information related to the TC65 and linked entities.

6.1 ATI Display product identification information

The `ATI` execute command delivers a product information text.
The 'Revision' information consists of the following parts: Version xx and variant yy of software release.

Syntax

```
Exec Command
ATI
Response(s)
SIEMENS
TC65
REVISION xx.yy
OK
```

```
Exec Command
ATI[<value>]
Response(s)
OK
```

Reference(s)	PIN	ASC0	ASC1	USB	MUX1	MUX2	MUX3	Charge	✈	Last
V.250	<input type="radio"/>	<input checked="" type="radio"/>	<input checked="" type="radio"/>	<input checked="" type="radio"/>	<input checked="" type="radio"/>	<input checked="" type="radio"/>	<input checked="" type="radio"/>	<input type="radio"/>	<input checked="" type="radio"/>	<input type="radio"/>

Parameter Description

`<value>`^(num)
Values are not supported and only return OK.

6.2 AT+CGMI Request manufacturer identification

[AT+CGMI](#) returns a manufacturer identification text. See also: [AT+GMI](#).

Syntax

Test Command	
AT+CGMI=?	
Response(s)	
OK	
Exec Command	
AT+CGMI	
Response(s)	
SIEMENS	
OK	
Reference(s)	
GSM 07.07	

PIN	ASC0	ASC1	USB	MUX1	MUX2	MUX3	Charge	→	Last
<input type="radio"/>	<input checked="" type="radio"/>	<input checked="" type="radio"/>	<input checked="" type="radio"/>	<input checked="" type="radio"/>	<input checked="" type="radio"/>	<input checked="" type="radio"/>	<input type="radio"/>	<input checked="" type="radio"/>	<input type="radio"/>

6.3 AT+GMI Request manufacturer identification

[AT+GMI](#) returns a manufacturer identification text. See also: [AT+CGMI](#).

Syntax

Test Command	
AT+GMI=?	
Response(s)	
OK	
Exec Command	
AT+GMI	
Response(s)	
SIEMENS	
OK	
Reference(s)	
V.250	

PIN	ASC0	ASC1	USB	MUX1	MUX2	MUX3	Charge	→	Last
<input type="radio"/>	<input checked="" type="radio"/>	<input checked="" type="radio"/>	<input checked="" type="radio"/>	<input checked="" type="radio"/>	<input checked="" type="radio"/>	<input checked="" type="radio"/>	<input type="radio"/>	<input checked="" type="radio"/>	<input type="radio"/>

6.4 AT+CGMM Request model identification

[AT+CGMM](#) returns a product model identification text. Command is identical with [AT+GMM](#).

Syntax

Test Command	
AT+CGMM=?	
Response(s)	
OK	
Exec Command	
AT+CGMM	
Response(s)	
TC65	
OK	
Reference(s)	
GSM 07.07	

PIN	ASC0	ASC1	USB	MUX1	MUX2	MUX3	Charge	→	Last
<input type="radio"/>	<input checked="" type="radio"/>	<input checked="" type="radio"/>	<input checked="" type="radio"/>	<input checked="" type="radio"/>	<input checked="" type="radio"/>	<input checked="" type="radio"/>	<input type="radio"/>	<input checked="" type="radio"/>	<input type="radio"/>

6.5 AT+GMM Request model identification

[AT+GMM](#) returns a product model identification text. Command is identical with [AT+CGMM](#).

Syntax

Test Command	
AT+GMM=?	
Response(s)	
OK	
Exec Command	
AT+GMM	
Response(s)	
TC65	
OK	
Reference(s)	
V.250	

PIN	ASC0	ASC1	USB	MUX1	MUX2	MUX3	Charge	→	Last
<input type="radio"/>	<input checked="" type="radio"/>	<input checked="" type="radio"/>	<input checked="" type="radio"/>	<input checked="" type="radio"/>	<input checked="" type="radio"/>	<input checked="" type="radio"/>	<input type="radio"/>	<input checked="" type="radio"/>	<input type="radio"/>

6.6 AT+CGMR Request revision identification of software status

[AT+CGMR](#) delivers a product firmware version identification. Command is identical with [AT+GMR](#).

Syntax

Test Command	
AT+CGMR=?	
Response(s)	
OK	
Exec Command	
AT+CGMR	
Response(s)	
REVISION <xx.yy>	
OK	
Reference(s)	
GSM 07.07	



Parameter Description

<xx.yy> ^(str)
Version xx and variant yy of software release.

6.7 AT+GMR Request revision identification of software status

[AT+GMR](#) delivers a product firmware version identification. Command is identical with [AT+CGMR](#).

Syntax

Test Command	
AT+GMR=?	
Response(s)	
OK	
Exec Command	
AT+GMR	
Response(s)	
REVISION <xx.yy>	
OK	
Reference(s)	
V.250	



Parameter Description

<xx.yy> ^(text)
Version xx and variant yy of software release.

6.8 AT+CGSN Request International Mobile Equipment Identity (IMEI)

[AT+CGSN](#) delivers the International Mobile Equipment Identity (IMEI). Command is identical with: [AT+GSN](#).

Syntax

Test Command																					
AT+CGSN=?																					
Response(s)																					
OK																					
Exec Command																					
AT+CGSN																					
Response(s)																					
<sn>																					
OK																					
Reference(s)																					
GSM 07.07																					
	<table border="1"> <tr> <td>PIN</td> <td>ASC0</td> <td>ASC1</td> <td>USB</td> <td>MUX1</td> <td>MUX2</td> <td>MUX3</td> <td>Charge</td> <td>✈</td> <td>Last</td> </tr> <tr> <td><input type="radio"/></td> <td><input checked="" type="radio"/></td> <td><input checked="" type="radio"/></td> <td><input checked="" type="radio"/></td> <td><input checked="" type="radio"/></td> <td><input checked="" type="radio"/></td> <td><input checked="" type="radio"/></td> <td><input type="radio"/></td> <td><input checked="" type="radio"/></td> <td><input type="radio"/></td> </tr> </table>	PIN	ASC0	ASC1	USB	MUX1	MUX2	MUX3	Charge	✈	Last	<input type="radio"/>	<input checked="" type="radio"/>	<input checked="" type="radio"/>	<input checked="" type="radio"/>	<input checked="" type="radio"/>	<input checked="" type="radio"/>	<input checked="" type="radio"/>	<input type="radio"/>	<input checked="" type="radio"/>	<input type="radio"/>
PIN	ASC0	ASC1	USB	MUX1	MUX2	MUX3	Charge	✈	Last												
<input type="radio"/>	<input checked="" type="radio"/>	<input checked="" type="radio"/>	<input checked="" type="radio"/>	<input checked="" type="radio"/>	<input checked="" type="radio"/>	<input checked="" type="radio"/>	<input type="radio"/>	<input checked="" type="radio"/>	<input type="radio"/>												

Parameter Description

<sn> ^(str)
International Mobile Equipment Identity (IMEI) used to identify a GSM mobile equipment to the GSM network

6.9 AT+GSN Request International Mobile Equipment Identity (IMEI)

[AT+GSN](#) delivers the International Mobile Equipment Identity (IMEI). Command is identical with [AT+CGSN](#)

Syntax

Test Command																					
AT+GSN=?																					
Response(s)																					
OK																					
Exec Command																					
AT+GSN																					
Response(s)																					
<sn>																					
OK																					
Reference(s)																					
V.250																					
	<table border="1"> <tr> <td>PIN</td> <td>ASC0</td> <td>ASC1</td> <td>USB</td> <td>MUX1</td> <td>MUX2</td> <td>MUX3</td> <td>Charge</td> <td>✈</td> <td>Last</td> </tr> <tr> <td><input type="radio"/></td> <td><input checked="" type="radio"/></td> <td><input checked="" type="radio"/></td> <td><input checked="" type="radio"/></td> <td><input checked="" type="radio"/></td> <td><input checked="" type="radio"/></td> <td><input checked="" type="radio"/></td> <td><input type="radio"/></td> <td><input checked="" type="radio"/></td> <td><input type="radio"/></td> </tr> </table>	PIN	ASC0	ASC1	USB	MUX1	MUX2	MUX3	Charge	✈	Last	<input type="radio"/>	<input checked="" type="radio"/>	<input checked="" type="radio"/>	<input checked="" type="radio"/>	<input checked="" type="radio"/>	<input checked="" type="radio"/>	<input checked="" type="radio"/>	<input type="radio"/>	<input checked="" type="radio"/>	<input type="radio"/>
PIN	ASC0	ASC1	USB	MUX1	MUX2	MUX3	Charge	✈	Last												
<input type="radio"/>	<input checked="" type="radio"/>	<input checked="" type="radio"/>	<input checked="" type="radio"/>	<input checked="" type="radio"/>	<input checked="" type="radio"/>	<input checked="" type="radio"/>	<input type="radio"/>	<input checked="" type="radio"/>	<input type="radio"/>												

Parameter Description

<sn> ^(str)
International Mobile Equipment Identity (IMEI) used to identify a GSM mobile equipment to the GSM network.

6.10 AT+CIMI Request International Mobile Subscriber Identity (IMSI)

AT+CIMI delivers the International Mobile Subscriber Identity (IMSI). The IMSI permits the TE to identify the individual SIM attached to the ME.

Syntax

Test Command	
AT+CIMI=?	
Response(s)	
OK	
Exec Command	
AT+CIMI	
Response(s)	
<imsi>	
OK	
ERROR	
+CME ERROR: <err>	
Reference(s)	
GSM 07.07	
	PIN ASC0 ASC1 USB MUX1 MUX2 MUX3 Charge ✈ Last
	● ● ● ● ● ● ● ○ ● ○

Parameter Description

<imsi>^(str)
International Mobile Subscriber Identity (string without quotes).

7. Call related Commands

The AT Commands described in this chapter are related to Mobile Originated (MOC, i.e. outgoing) Calls and Mobile Terminated (MTC, i.e. incoming) Calls.

7.1 Call Status Information

For Circuit switched calls, including voice, fax and data calls, call status information is available with URC "+CIEV: call" (configurable via AT commands [AT+CIND](#) and [AT+CMER](#)) or - in more detail - from the list of current calls. This list can be displayed on request via at commands [AT+CLCC](#) and [AT^SLCC](#). It can also be issued by the ME in the form of an unsolicited result code "[AT^SLCC](#)" if configured with [AT^SLCC](#) and [AT+CMER](#). URC "+CIEV: call" and URC "[AT^SLCC](#)" can be configured using AT command [AT^SCFG](#). An overview of the possible configurations and their consequences for the availability of call status information will be given here.

Generally speaking, the call status values recognized by the ME are as follows:

- active
- held
- dialing (MOC)
- alerting (MOC)
- incoming (MTC)
- waiting (MTC)
- terminating: The call is not active anymore, but inband information is still available.
- dropped: The call has been suspended by the network, but may be resumed later.

The values "terminating" and "dropped" are not standardized for AT command [AT+CLCC](#), and therefore only available for command [AT^SLCC](#). A call in any of these two states will not appear in the list of current calls as displayed with [AT+CLCC](#).

A call that is not recognized by the ME is considered to be in "unknown" state.

Some networks may schedule a traffic channel for a call that is not yet in the "active" state. This is reflected in parameter [<traffic channel assigned>](#) of AT command [AT^SLCC](#) and the corresponding URC.

Depending on the value of [AT^SCFG](#) setting [<succ>](#), Indicator "+CIEV" will be issued (if configured with [AT+CIND](#) and [AT+CMER](#))

- when a state transition ends in state "active" or in state "unknown" (if [AT^SCFG](#) setting [<succ>](#)="restricted").
- when any state transition (including transitions beginning or ending in state "unknown") occurs in the list of active calls, or when a traffic channel is established (if [AT^SCFG](#) setting [<succ>](#)="verbose").

The indicator value for indicator "+CIEV: call" will be "1" if at least one call is in states "held" or "active", and "0" otherwise.

Depending on the value of [AT^SCFG](#) setting [<sucs>](#), Indicator "[AT^SLCC](#)" will be issued (if configured with write command [AT^SLCC](#) and [AT+CMER](#))

- when a state transition ends in state "active" or in state "unknown" (if [AT^SCFG](#) setting [<sucs>](#)="restricted")
- when any state transition (including transitions beginning or ending in state "unknown") occurs in the list of active calls, or when a voice channel is established (if [AT^SCFG](#) setting [<sucs>](#)="verbose").

Due to compatibility considerations, the powerup default for [AT^SCFG](#) setting [<succ>](#) is "restricted", offering compatibility to the standard behaviour of indicator "+CIEV: call", while the default for setting [<sucs>](#) is "verbose".

In order to see the URCS, event reporting for both indicators must be explicitly configured with the appropriate AT commands.

7.2 ATA Answer a call

Syntax

Exec Command	
ATA	
Response(s)	
In case of data call, if successfully connected (TA switches to data mode): CONNECT <text>	
In case of voice call, if successfully connected: OK	
When TA returns to command mode after call release: OK	
If no connection: NO CARRIER	
Reference(s)	PIN ASC0 ASC1 USB MUX1 MUX2 MUX3 Charge → Last
V.250	● ● ● ● ● ● ● ○ ○ ○

Command Description

TA causes remote station to go off-hook (e.g. answer call).

Parameter Description

<text> ^(str)
Connection status
<text> output only if ATX parameter setting with value greater 0.

Notes

- Any additional commands on the same command line are ignored.
- The command may be aborted generally by receiving a character during execution. It can't be aborted in some connection setup states, such as handshaking.
- If [AT+FCLASS](#) setting is 1 or 2, all incoming calls will be answered as fax calls, when ATA is issued on multiplexer channel 1 resp. ASC0. For calls explicitly signalled as voice or data calls, this procedure will fail with result code "NO CARRIER", but the call in question will continue to ring. It is possible to change the setting for [AT+FCLASS](#) to 0 while the call is ringing, and accept the call normally afterwards with [ATA](#).
- The ATA command may be used also to accept a network request for a PDP context activation (see [ATA](#)).
- See also [ATX](#) for <text>.
- If an incoming call is no longer available (already disconnected/hanged up) a "NO CARRIER" result code will be given.

7.3 ATD Mobile originated call to specified number

Syntax

Exec Command	
ATD<n>[<mgsms>][:]	
Response(s)	
If no dialtone (parameter setting ATX2 or ATX4): NO DIALTONE	
If busy (parameter setting ATX3 or ATX4): BUSY	
If a connection cannot be set up: NO CARRIER OK	
If successfully connected and non-voice call (TA switches to online data mode): CONNECT <text>	
When TA returns to command mode after call release: OK	
If successfully connected and voice call: OK	
Reference(s)	PIN ASC0 ASC1 USB MUX1 MUX2 MUX3 Charge → Last
V.250	

Command Description

This command can be used to set up outgoing voice, data or fax calls. It also serves to control Supplementary Services. The termination character ":" is mandatory to set up voice calls or to send *# codes for Supplementary Services. It must not be used for data and fax calls.

Additional notes on the responses returned after dialing with [ATD](#):

- For voice calls, you have the choice of two different response modes that can be selected with [AT^SM20](#):
[AT^SM20=1](#) (factory default) causes the ME to respond once the call setup is completed either successfully ("OK") or unsuccessfully ("NO CARRIER", "NO DIAL TONE", "BUSY").
[AT^SM20=0](#) causes the ME to return "OK" immediately after dialing was completed (i.e. before call setup terminates successfully or unsuccessfully).
- For data connections, call setup always terminates when the call has been established (indicated by the result code "CONNECT <text>"), or when it fails (indicated by "NO CARRIER"). The settings of [AT^SM20](#) do not apply.

Different call release indications:

- Upon termination, an outgoing fax or data call may show a different result code than a voice call would show under identical conditions. In order to track down the actual reason for call termination, [AT+CEER](#) or [ATS18](#) should be used for all applicable connections.

Using [ATD](#) during an active call:

- When a user originates a second voice call while there is already an active voice call, the first call will automatically put on hold. The second call attempt is acknowledged with "OK" immediately after dialing with [ATD](#) has completed, without relation to a successful call setup. In case of failure, the additional result codes "NO CARRIER", "NO DIAL TONE", "NO CARRIER" will be presented afterwards (see example below).

Parameter Description

<n> ^(text)
String of dialing digits and optional V.250 modifiers: 0-9, *, #, +, A, B, C The following V.250 modifiers are ignored: ,(comma), T, P, !, W ,@ Emergency call : <n> = 112, 911 or 08, standardized GSM emergency number (no SIM needed).

<mgsms>^(str)

String of GSM modifiers:

- I Activates CLIR (disables presentation of own phone number to called party)
- i Deactivates CLIR (enables presentation of own phone number to called party)
- G Activate Closed User Group explicit invocation for this call only.
- g Deactivate Closed User Group explicit invocation for this call only.

Notes

- The command may be aborted generally when receiving an [ATH](#) command during execution. It cannot be aborted in some connection setup states, such as handshaking.
- Parameter "I" and "i" only if no *#-code is within the dial string.
- <mgsms> is not supported for data calls.
- <n> is default for last number that can be dialled by [ATDL](#).
- See also [ATX](#) for <text>.
- If [ATD](#) is used with a USSD command (e.g. ATD*100#;) an AT+CUSD=1 is executed implicitly (see [AT+CUSD](#)).
- Parameter 'G' or 'g' will be ignored if Closed User Group was already activated, respectively deactivated with [AT+CCUG](#) command before. Call by call invocation of CUG uses the settings provisioned by the provider or, if available, the settings of the parameters <index> and <info> made with [AT+CCUG](#).
- The ME is equipped with a "Blacklist" function according to GSM02.07 Annex A:
After a predefined number of failed call attempts, the dialed number is entered into a read-only phonebook called "blacklist" (phonebook "BL"). Call attempts to numbers contained in the blacklist will be barred by ME and not signalled to the network.
An attempt to start a voice call to a barred phone number will be stopped with a CME ERROR 257 "Call Barred".
An attempt to start a data or fax call to a barred phone number will be answered immediately with result code "NO CARRIER".
The barred numbers are automatically removed from the blacklist according to the timing conditions specified in GSM02.07 Annex A.

Example

The following example shows the call setup procedure when a call is already active and a second call attempt fails because the line of the called party is busy:

atd03012345678	Dialing out the first party's number.
OK	The first call is established.
ATD03022222222	The number of the second party is dialed.
OK	The response "OK" is issued immediately though no call is established (same behavior as is you had chosen AT^SM20=0 .)
BUSY	Line of the second called party is busy.

7.4 ATD<mem><n> Mobile originated call using specific memory and index number

Syntax

Exec Command	
ATD<mem><n>[<mgsm>];	
Response(s)	
ERROR	
+CME ERROR: <err>	
If no dialtone (parameter ATX2 or ATX4):	
NO DIALTONE	
If busy (parameter setting ATX3 or ATX4):	
BUSY	
If connection cannot be set up:	
NO CARRIER	
When TA returns to command mode after call release:	
OK	
If successfully connected:	
OK	
Reference(s)	PIN ASC0 ASC1 USB MUX1 MUX2 MUX3 Charge → Last
V.250	● ● ○ ● ● ○ ○ ○ ○ ○

Command Description

TA attempts to set up an outgoing call to the specified number. The termination character ";" is mandatory since dialing from a phonebook is only supported for voice calls and for sending *# codes of Supplementary Services or other functions.

Parameter Description

<mem> ^(str)	
Phonebook storage: For detailed description of storages see AT+CPBS .	
"FD"	Fixed dialing phonebook
"SM"	SIM phonebook
"ON"	MSISDN list
"ME"	Mobile Equipment Phonebook
"LD"	Last number dialed phonebook
"MC"	Missed (unanswered received) calls list
"RC"	Received calls list
<n> ^(num)	
Integer type memory location in the range of locations available in the selected memory, i.e. the index number returned by AT+CPBR .	
<mgsm> ^(str)	
String of GSM modifiers:	
l	Activates CLIR (disables presentation of own phone number to called party)
i	Deactivates CLIR (enables presentation of own phone number to called party)

Notes

- This command may be aborted generally by receiving a character during execution. Abortion is not possible during some states of connection setup such as handshaking.
- There is no <mem> for emergency call ("EN").
- The command is not applicable to data calls. Any attempt to dial a data call number from <mem> causes the result code "NO CARRIER" to appear.
- Parameter <mgsms> only if no *# code is within the dialing string.
- See [ATX](#) for setting result code and call monitoring parameters.

Examples

EXAMPLE 1

To query the location number of the phonebook entry:

```
AT+CPBR=1,xx
```

TA returns the entries available in the active phonebook.

EXAMPLE 2

To dial a number from the SIM phonebook, for example the number stored to location 15:

```
ATD>SM15 ;  
OK
```

EXAMPLE 3

To dial a phone number stored in the last dial memory on the SIM card:

```
ATD>LD9 ;  
OK
```

7.5 ATD<n> Mobile originated call from active memory using index number

Syntax

Exec Command	
ATD<n>[<mgsms>];	
Response(s)	
ERROR	
+CME ERROR: <err>	
If no dialtone (parameter ATX2 or ATX4):	
NO DIALTONE	
If busy (parameter setting ATX3 or ATX4):	
BUSY	
If connection cannot be set up:	
NO CARRIER	
When TA returns to command mode after call release:	
OK	
If successfully connected:	
OK	
Reference(s)	PIN ASC0 ASC1 USB MUX1 MUX2 MUX3 Charge → Last
V.250	● ● ◐ ● ● ◐ ◐ ○ ○ ○

Command Description

TA attempts to set up an outgoing call to the stored number. The termination character ";" is mandatory since dialing from a phonebook is only supported for voice calls and for sending *# codes of Supplementary Services or other functions.

Parameter Description

<n>^(num)

Integer type memory location in the range of locations available in the selected memory, i.e. the index number returned by [AT+CPBR](#).

<mgsms>^(str)

String of GSM modifiers:

- l Activates CLIR (disables presentation of own phone number to called party)
- i Deactivates CLIR (enables presentation of own phone number to called party)

Notes

- This command may be aborted generally by receiving a character during execution. Abortion is not possible during some states of connection setup such as handshaking.
- The command is not applicable to data calls. Any attempt to dial a data call number from <n> causes the result code "NO CARRIER" to appear.
- Parameter <mgsms> only if no *# code is within the dialing string.

7.6 ATD<str> Mobile originated call from active memory using corresponding field

Syntax

Exec Command	ATD<str>[<mgsm>];
Response(s)	<p>ERROR</p> <p>+CME ERROR: <err></p> <p>If no dialtone (parameter ATX2 or ATX4): NO DIALTONE</p> <p>If busy (parameter setting ATX3 or ATX4): BUSY</p> <p>If connection cannot be set up: NO CARRIER</p> <p>When TA returns to command mode after call release: OK</p> <p>If successfully connected: OK</p>
Reference(s)	V.250

Command Description

This command searches the active phonebook for a given string <str> and dials the assigned phone number. The termination character ";" is mandatory since dialing from a phonebook is only supported for voice calls and for sending *# codes of Supplementary Services or other functions.

Parameter Description

<str>^{(str)(+CSCS)}

String type value ("x"), which should equal an alphanumeric field in at least one phonebook entry in the searched memories; used character set should be the one selected with AT+CSCS. <str> can contain escape sequences as described in chapter "Supported character sets".

<str> must be wrapped in quotation marks (""), if escape sequences or parameter <mgsm> are used or if the alphanumeric strings contains a blank. If not, quotation marks are optional.

If AT+CSCS is set to "UCS2", with respect to the coding of UCS2-characters only phonebook entries that contain an alphanumeric string with as size less than the half of the paramter <tlength> from AT+CPBW can be dialed.

<mgsm>^(str)

String of GSM modifiers:

- l Activates CLIR (disables presentation of own phone number to called party)
- i Deactivates CLIR (enables presentation of own phone number to called party)

Notes

- This command may be aborted generally by receiving a character during execution. Abortion is not possible during some states of connection setup such as handshaking.
- The command is not applicable to data calls. Any attempt to dial <str> without semicolon ";" causes the result code "NO CARRIER" to appear.
- Parameter <mgsm> only if no *# code is within the dialing string.

7.7 ATDI Mobile originated call to ISDN number

Syntax

Exec Command	
ATDI <n>[:]	
Response(s)	
If no dialtone (parameter ATX2 or ATX4): NO DIALTONE	
If busy (parameter setting ATX3 or ATX4): BUSY	
If connection cannot be set up: NO CARRIER	
All other error reasons: +CME ERROR	
If successfully connected and non-voice call (TA switches to data state): CONNECT <text>	
When TA returns to command mode after call release: OK	
If successfully connected and voice call: OK	
Reference(s)	PIN ASC0 ASC1 USB MUX1 MUX2 MUX3 Charge → Last
V.250	● ● ○ ● ● ○ ○ ○ ○ ○

Command Description

TA attempts to set up an outgoing call to ISDN number. The termination character ";" is mandatory to set up voice calls or to send *# codes for Supplementary Services. It must not be used for data and fax calls.

Parameter Description

<n> ^(str)
ISDN number String with maximum length of 20 characters. Allowed characters: +, 0-9, A, B, C.

Note

- This command may be aborted generally by receiving a character during execution. Abortion is not possible during some states of connection setup such as handshaking.

7.8 ATDL Redial last number used

Syntax

Exec Command	
ATDL[:]	
Response(s)	
If there is no last number or number is not valid: +CME ERROR	
If no dialtone (parameter ATX2 or ATX4): NO DIALTONE	
If busy (parameter setting ATX3 or ATX4): BUSY	
If connection cannot be set up: NO CARRIER	
If successfully connected and non-voice call (TA switches to online data mode): CONNECT <text>	
When TA returns to command mode after call release: OK	
If successfully connected and voice call: OK	
Reference(s)	PIN ASC0 ASC1 USB MUX1 MUX2 MUX3 Charge → Last
V.250	● ● ◐ ● ● ◐ ◐ ○ ○ ○

Command Description

This command redials the last voice and data call number used in the ATD command. If terminated with semi-colon ";", ATDL dials the last voice call number stored in the "LD" phonebook. Otherwise, the last dialed data or fax number will be used (not contained in the "LD" phonebook).

Notes

- This command may be aborted generally by receiving a character during execution. Abortion is not possible during some states of connection setup such as handshaking.
- Parameter "l" and "i" only if no *#-code is within the dial string.

7.9 ATH Disconnect existing connection

Syntax

Exec Command	
ATH[<n>]	
Response(s)	
OK	
Reference(s)	PIN ASC0 ASC1 USB MUX1 MUX2 MUX3 Charge → Last
V.250	<input type="radio"/> <input checked="" type="radio"/> <input checked="" type="radio"/> <input checked="" type="radio"/> <input checked="" type="radio"/> <input checked="" type="radio"/> <input checked="" type="radio"/> <input checked="" type="radio"/> <input type="radio"/> <input type="radio"/> <input type="radio"/>

Command Description

Disconnect existing call from command line by local TE and terminate call.

Parameter Description

<n> ^(num)
[0] disconnect from line and terminate call

Notes

- OK is issued after circuit 109 (DCD) is turned off, if it was previously on.
- ATH terminates every circuit switched call (voice, data or fax), even if it is issued via another interface. This behavior is in accordance with ITU-T V.250; (07/97, "Hook control": "ATH is terminating any call in progress.").
- ATH clears any active PDP context or terminates any existing PPP connection, but only if issued on the same interface where GPRS is used and if there is no pending network request for PDP context activation. It does not affect PDP contexts and PPP connections on other interfaces (see also Chapter "ATH Manual rejection of a network request for PDP context activation").

7.10 AT+CHUP Hang up call

Syntax

Test Command	
AT+CHUP=?	
Response(s)	
OK	
ERROR	
+CME ERROR	
Exec Command	
AT+CHUP	
Response(s)	
OK	
ERROR	
+CME ERROR	
Reference(s)	
GSM 07.07	

PIN	ASC0	ASC1	USB	MUX1	MUX2	MUX3	Charge	✈	Last
●	●	●	●	●	●	●	○	○	○

Command Description

Cancels all active and held calls.

Note

- [AT+CHUP](#) implements the same behaviour as [ATH](#).

7.11 AT^SHUP Hang up call(s) indicating a specific GSM04.08 release cause

Syntax

Test Command	AT^SHUP=?
Response(s)	OK
Write Command	AT^SHUP=<cause>[, <cn>]
Response(s)	ERROR OK
Reference(s)	Siemens

Command Description

The write command serves to end one specific call or all calls known to the ME, indicating a specific GSM04.08 release cause specified by the user. The command can be used for voice, fax and data calls in any call status (i.e. any calls listed by [AT+CLCC](#)).

Parameter Description

<cause>^(num)	
release cause	
Release cause from GSM04.08 to be indicated to the network.	
The TC65 will release the selected connection(s) with release cause indication "cause" and location "user" (0) in the "disconnect" protocol message to the GSM Network. It depends on the network whether or not the release cause will be forwarded to the remote party.	
1	send GSM04.08 release cause "unassigned (unallocated) number"
16	send GSM04.08 release cause "Normal call clearing "
17	send GSM04.08 release cause "User busy "
18	send GSM04.08 release cause "No user responding "
27	send GSM04.08 release cause "Destination out of order "
31	send GSM04.08 release cause "Normal, unspecified"

<cn>^(num)	
call number	
The "call number" is an optional index into the list of current calls available via AT+CLCC . AT command AT^SHUP will terminate the call identified by the specified call number. The default call number "0" is not assigned to any call, but signifies "all calls". As "0" is the default value, it may be omitted.	
With AT^SHUP , Calls will be terminated regardless of their current call status, which may be any of the states allowed by AT+CLCC .	
[0]	terminate all known calls
1...7	terminate the specific call number <cn>

Notes

- it depends on the network whether or not a delivered release cause will be forwarded to the remote party.
- With [AT^SHUP](#), Calls will be terminated regardless of their current call status, which may be any of the states allowed by [AT+CLCC](#).

7.12 ATSO Set number of rings before automatically answering a call

This command determines the number of rings before automatic answering a call.

Syntax

<p>Read Command</p> <p>ATSO?</p> <p>Response(s)</p> <p><n></p> <p>OK</p> <p>ERROR</p>	
<p>Write Command</p> <p>ATSO=<n></p> <p>Response(s)</p> <p>OK</p> <p>ERROR</p>	
<p>Reference(s)</p> <p>V.250</p>	<p>PIN ASC0 ASC1 USB MUX1 MUX2 MUX3 Charge → Last</p> <p>○ ● ● ● ● ● ● ○ ○ ○</p>

Parameter Description

<n> ^{(num)(&W)(&V)}	Description
000 ^(&F)	Automatic answer mode is disabled.
001-255	Enable automatic answering after specified number of rings.

Notes

- This command works for MT data and fax calls.
- Autoanswering of CSD data and fax calls is supported on ASC0/Mux1 only.
- If <n> is set to higher values, the calling party may hang up before the call is automatically answered.
- The correlation between [ATS7](#) and [ATSO](#) is important.
Example: Call setup may fail if ATS7=30 and ATSO=20.
- Setting is local to the interface. It is allowed to have different settings on different interfaces. In such cases the interface 'wins', which is idle and uses the smallest <n> value.
- The ATSO write command is PIN protected.
- The command ATSO is also used as GPRS compatibility command to answer automatically to a network request for PDP context activation (for details see [ATSO](#) for GPRS). So using ATSO=<n> with n > 0, will perform a GPRS attach, if the ME is not already GPRS attached and if ME is configured to do so (see [AT^SCFG](#), parameter <gs0aa>). If the GPRS attach fails (e.g. the network rejects the attach request), the write command returns an error, though the new value takes effect.
The GPRS attach will not be performed on recalling a stored user profile with [ATZ](#) or on powerup, if a n > 0 setting was stored in the user profile with [AT&W](#).

7.13 ATS6 Set pause before blind dialing

Syntax

Read Command	
ATS6?	
Response(s)	
<n>	
OK	
Write Command	
ATS6=<n>	
Response(s)	
OK	
ERROR	
Reference(s)	
V.250	
	PIN ASC0 ASC1 USB MUX1 MUX2 MUX3 Charge → Last
	<input type="radio"/> <input checked="" type="radio"/> <input type="radio"/> <input checked="" type="radio"/> <input checked="" type="radio"/> <input type="radio"/> <input type="radio"/> <input type="radio"/> <input checked="" type="radio"/> <input type="radio"/>

Command Description

No effect for GSM.

Parameter Description

<n> ^{(num)(&W)(&V)}
000 ^(&F) ...255

7.14 AT57 Set number of seconds to wait for connection completion

AT57 specifies the number of seconds the TA will wait for the completion of the call setup when answering or originating a data call. Also referred to as "no answer timeout". To put it plainly, this is the time to wait for the carrier signal. If no carrier signal is received within the specified time, the TA hangs up.

Syntax

Read Command																					
AT57?																					
Response(s)																					
<n>																					
OK																					
Write Command																					
AT57=<n>																					
Response(s)																					
OK																					
ERROR																					
Reference(s)	<table border="1"> <tr> <td>PIN</td> <td>ASC0</td> <td>ASC1</td> <td>USB</td> <td>MUX1</td> <td>MUX2</td> <td>MUX3</td> <td>Charge</td> <td>→</td> <td>Last</td> </tr> <tr> <td><input type="radio"/></td> <td><input checked="" type="radio"/></td> <td><input type="radio"/></td> <td><input checked="" type="radio"/></td> <td><input checked="" type="radio"/></td> <td><input type="radio"/></td> <td><input type="radio"/></td> <td><input type="radio"/></td> <td><input checked="" type="radio"/></td> <td><input type="radio"/></td> </tr> </table>	PIN	ASC0	ASC1	USB	MUX1	MUX2	MUX3	Charge	→	Last	<input type="radio"/>	<input checked="" type="radio"/>	<input type="radio"/>	<input checked="" type="radio"/>	<input checked="" type="radio"/>	<input type="radio"/>	<input type="radio"/>	<input type="radio"/>	<input checked="" type="radio"/>	<input type="radio"/>
PIN	ASC0	ASC1	USB	MUX1	MUX2	MUX3	Charge	→	Last												
<input type="radio"/>	<input checked="" type="radio"/>	<input type="radio"/>	<input checked="" type="radio"/>	<input checked="" type="radio"/>	<input type="radio"/>	<input type="radio"/>	<input type="radio"/>	<input checked="" type="radio"/>	<input type="radio"/>												
V.250																					

Parameter Description

<n> ^{(num)(&W)(&V)}
Number of seconds to wait for connection completion
000...060 ^(&F)

Notes

- Command **AT57** is only applicable to data calls.
- Values greater than 60 (maximum 255) cause no error, but <n> will be restored to the maximum value of 60.
- The correlation between **AT57** and **AT50** is important. If the called party has specified a high value for **AT50=<n>** call setup may fail.
Example: Call setup may fail if AT57=30 and AT50=20.

7.15 AT58 Set number of seconds to wait for comma dialing modifier

This command specifies the amount of time, in seconds, that the DCE shall pause, during signalling of call addressing information to the network (dialling), when a "," (comma) dial modifier is encountered in a dial string.

Syntax

Read Command																					
AT58?																					
Response(s)																					
<n>																					
OK																					
Write Command																					
AT58=<n>																					
Response(s)																					
OK																					
ERROR																					
Reference(s)	<table border="1"> <tr> <td>PIN</td> <td>ASC0</td> <td>ASC1</td> <td>USB</td> <td>MUX1</td> <td>MUX2</td> <td>MUX3</td> <td>Charge</td> <td>✈</td> <td>Last</td> </tr> <tr> <td><input type="radio"/></td> <td><input checked="" type="radio"/></td> <td><input type="radio"/></td> <td><input checked="" type="radio"/></td> <td><input checked="" type="radio"/></td> <td><input type="radio"/></td> <td><input type="radio"/></td> <td><input type="radio"/></td> <td><input type="radio"/></td> <td><input checked="" type="radio"/></td> </tr> </table>	PIN	ASC0	ASC1	USB	MUX1	MUX2	MUX3	Charge	✈	Last	<input type="radio"/>	<input checked="" type="radio"/>	<input type="radio"/>	<input checked="" type="radio"/>	<input checked="" type="radio"/>	<input type="radio"/>	<input type="radio"/>	<input type="radio"/>	<input type="radio"/>	<input checked="" type="radio"/>
PIN	ASC0	ASC1	USB	MUX1	MUX2	MUX3	Charge	✈	Last												
<input type="radio"/>	<input checked="" type="radio"/>	<input type="radio"/>	<input checked="" type="radio"/>	<input checked="" type="radio"/>	<input type="radio"/>	<input type="radio"/>	<input type="radio"/>	<input type="radio"/>	<input checked="" type="radio"/>												
V.250																					

Command Description

No effect for GSM.

Parameter Description

<n> ^{(num)(&W)(&V)}	
0 ^(&F)	DCE does not pause when "," encountered in dial string
1...255	Number of seconds to pause

7.16 AT510 Set disconnect delay after indicating the absence of data carrier

Syntax

Read Command	
AT510?	
Response(s)	
<n>	
OK	
Write Command	
AT510=<n>	
Response(s)	
OK	
ERROR	
Reference(s)	
V.250	
	PIN ASC0 ASC1 USB MUX1 MUX2 MUX3 Charge → Last
	<input type="radio"/> <input checked="" type="radio"/> <input type="radio"/> <input checked="" type="radio"/> <input checked="" type="radio"/> <input type="radio"/> <input type="radio"/> <input type="radio"/> <input type="radio"/> <input checked="" type="radio"/> <input type="radio"/>

Command Description

This parameter setting determines the amount of time, that the TA remains connected in absence of a data carrier. If the data carrier is detected before disconnect, the TA remains connected.

Parameter Description

<n> ^{(num)(&W)(&V)}
number of tenths of seconds of delay
001...2 ^(&F) ...254

7.17 ATO Switch from command mode to data mode / PPP online mode

Syntax

Exec Command																					
ATO[<n>]																					
Response(s)																					
If connection is not successfully resumed: NO CARRIER or TA returns to data mode from command mode CONNECT <text> Note: <text> output only if ATX parameter setting with value > 0.																					
Reference(s)	<table border="1"> <tr> <td>PIN</td> <td>ASC0</td> <td>ASC1</td> <td>USB</td> <td>MUX1</td> <td>MUX2</td> <td>MUX3</td> <td>Charge</td> <td>→</td> <td>Last</td> </tr> <tr> <td><input type="radio"/></td> <td><input checked="" type="radio"/></td> <td><input type="radio"/></td> <td><input checked="" type="radio"/></td> <td><input checked="" type="radio"/></td> <td><input type="radio"/></td> <td><input type="radio"/></td> <td><input type="radio"/></td> <td><input type="radio"/></td> <td><input type="radio"/></td> </tr> </table>	PIN	ASC0	ASC1	USB	MUX1	MUX2	MUX3	Charge	→	Last	<input type="radio"/>	<input checked="" type="radio"/>	<input type="radio"/>	<input checked="" type="radio"/>	<input checked="" type="radio"/>	<input type="radio"/>	<input type="radio"/>	<input type="radio"/>	<input type="radio"/>	<input type="radio"/>
PIN	ASC0	ASC1	USB	MUX1	MUX2	MUX3	Charge	→	Last												
<input type="radio"/>	<input checked="" type="radio"/>	<input type="radio"/>	<input checked="" type="radio"/>	<input checked="" type="radio"/>	<input type="radio"/>	<input type="radio"/>	<input type="radio"/>	<input type="radio"/>	<input type="radio"/>												
V.250																					

Command Description

ATO is the corresponding command to the +++ escape sequence: When you have established a CSD call or a GPRS connection and TA is in command mode, ATO causes the TA to resume the data or GPRS connection and takes you back to data mode or PPP online mode.

Parameter Description

<n> ^(num)	
[0]	Switch from command mode to data mode

7.18 +++ Switch from data mode to command mode

Syntax

Exec Command	
+++	
Response(s)	
OK	
Reference(s)	PIN ASC0 ASC1 USB MUX1 MUX2 MUX3 Charge → Last
V.250	<input type="radio"/> <input checked="" type="radio"/> <input type="radio"/> <input checked="" type="radio"/> <input type="radio"/> <input type="radio"/> <input type="radio"/> <input type="radio"/> <input type="radio"/> <input type="radio"/>

Command Description

This command is only available during a CSD call or a GPRS connection. The +++ character sequence causes the TA to cancel the data flow over the AT interface and switch to command mode. This allows you to enter AT commands while maintaining the data connection to the remote device or, accordingly, the GPRS connection. To prevent the +++ escape sequence from being misinterpreted as data, it must be preceded and followed by a pause of at least 1000 ms. The +++ characters must be entered in quick succession, all within 1000 ms.

Notes

- To return from command mode to data or PPP online mode: Enter [ATO](#).
- In Multiplex mode the +++ sequence does not work. Therefore, if required in Multiplex mode, the escape sequence needs to be implemented in the customer's external Multiplex application. Design solutions, for example using the DTR signal or a modem status command (MSC), can be found in [\[6\]](#), Section "Escape Sequence". See also Section [4.10](#), [AT+CMUX](#).
- On ASC1 the +++ sequence can be used in GPRS connections for switching from PPP online to command mode.

7.19 AT+CBST Select bearer service type

The **AT+CBST** write command selects the bearer service **<name>**, the data rate **<speed>** and the connection element **<ce>** to be used when data calls are originated. The settings also apply to mobile terminated data calls, especially when single numbering scheme calls or calls from analog devices are received (see **AT+CSNS**). See GSM 02.02[1] for a list of allowed combinations of subparameters.

Syntax

<p>Test Command</p> <p>AT+CBST=?</p> <p>Response(s)</p> <p>+CBST: (list of supported<speed>s), (list of supported<name>s), (list of supported<ce>s)</p> <p>OK</p>	
<p>Read Command</p> <p>AT+CBST?</p> <p>Response(s)</p> <p>+CBST: <speed>, <name>, <ce></p> <p>OK</p>	
<p>Write Command</p> <p>AT+CBST=<speed>[, <name>[, <ce>]]</p> <p>Response(s)</p> <p>OK</p> <p>ERROR</p>	
<p>Reference(s)</p> <p>GSM 07.07</p>	<p>PIN ASC0 ASC1 USB MUX1 MUX2 MUX3 Charge → Last</p> <p><input type="radio"/> <input checked="" type="radio"/> <input type="radio"/> <input checked="" type="radio"/> <input checked="" type="radio"/> <input type="radio"/> <input type="radio"/> <input type="radio"/> <input checked="" type="radio"/> <input type="radio"/></p>

Parameter Description

<speed> ^{(num)(&W)(&V)}	
0	Autobauding
4	2400 bps (V.22bis)
6	4800 bps (V.32)
[7] ^(&F)	9600 bps (V.32)
14	14400 bps (V.34)
68	2400 bps (V.110)
70	4800 bps (V.110)
71	9600 bps (V.110)
75	14400 bps (V.110)
<name> ^{(num)(&W)}	
0 ^(&F)	Asynchronous modem
<ce> ^{(num)(&W)}	
Transparent mode is not supported.	
1 ^(&F)	Non-transparent

7.20 AT+CRLP Select radio link protocol parameters for originated non-transparent data calls

The [AT+CRLP](#) write command sets radio link protocol (RLP) parameters used when non-transparent data calls are originated. The read command returns the current settings for the supported RLP version 0.

Syntax

<p>Test Command</p> <pre>AT+CRLP=?</pre> <p>Response(s)</p> <pre>+CRLP: (list of supported<iws>s), (list of supported<mws>s), (list of supported<T1>s), (list of supported<N2>s) OK</pre>	
<p>Read Command</p> <pre>AT+CRLP?</pre> <p>Response(s)</p> <pre>+CRLP: <iws>, <mws>, <T1>, <N2> OK</pre>	
<p>Write Command</p> <pre>AT+CRLP=[<iws>[, <mws>[, <T1>[, <N2>]]]]</pre> <p>Response(s)</p> <pre>OK ERROR +CME ERROR: <err></pre>	
<p>Reference(s)</p> <p>GSM 07.07</p>	

Parameter Description

<p><iws>^{(num)(&W)(&V)}</p> <p>Interworking window size (IWF to MS)</p> <p>0...61^(&F)</p>
<p><mws>^{(num)(&W)(&V)}</p> <p>Mobile window size (MS to IWF)</p> <p>0...61^(&F)</p>
<p><T1>^{(num)(&W)(&V)}</p> <p>Acknowledgement timer (T1 in 10 ms units)</p> <p>48...[78]^(&F)...255</p>
<p><N2>^{(num)(&W)(&V)}</p> <p>Re-transmission attempts N2</p> <p>1...6^(&F)...255</p>

7.21 AT+CLCC List current calls of ME

The execute command returns a list of current calls of ME. If command is successful, but no calls are available, no information response is sent to TE.

Syntax

Test Command	
AT+CLCC=?	
Response(s)	
OK	
Exec Command	
AT+CLCC	
Response(s)	
[+CLCC: <idx>, <dir>, <stat>, <mode>, <mpty>[, <number>, <type>[, <alpha>]]]	
[+CLCC: <idx>, <dir>, <stat>, <mode>, <mpty>[, <number>, <type>[, <alpha>]]]	
[+CLCC: ...]	
OK	
ERROR	
+CME ERROR	
Reference(s)	
GSM 07.07	

Parameter Description

<idx>^(num)

Call identification number as described in GSM02.30 subclause 4.5.5.1; this number can be used in [AT+CHLD](#) command operations

<dir>^(num)

0	Mobile originated call (MOC)
1	Mobile terminated call (MTC)

<stat>^(num)

State of the call

0	Active
1	Held
2	Dialing (MOC)
3	Alerting (MOC)
4	Incoming (MTC)
5	Waiting (MTC)

<mode>^(num)

Bearer/teleservice

0	Voice
1	Data
2	Fax

3	Voice followed by data, voice mode (only in connection with single numbering scheme AT+CSNS)
4	Alternating voice/data, voice mode (only in connection with single numbering scheme AT+CSNS)
5	Alternating voice/fax, voice mode (only in connection with single numbering scheme AT+CSNS)
6	Voice followed by data, data mode (only in connection with single numbering scheme AT+CSNS)
7	Alternating voice/data, data mode (only in connection with single numbering scheme AT+CSNS)
8	Alternating voice/fax, fax mode (only in connection with single numbering scheme AT+CSNS)
9	Unknown

<mppty>^(num)

0	Call is not one of multiparty (conference) call parties
1	Call is one of multiparty (conference) call parties

<number>^(str)

Phone number in format specified by [<type>](#)

<type>^(num)

Type of address octect

145	Dialing string <number> includes international access code character '+'
129	Otherwise

<alpha>^{(str)(+CSCS)}

Alphanumeric representation of [<number>](#) corresponding to the entry found in phonebook; used character set should be the one selected with command [AT+CSCS](#) (Select TE Character Set).

The maximum displayed length of [<alpha>](#) is 16 characters. If [<alpha>](#) has more than 16 characters, only the first 15 characters are displayed. To indicate an overflow, a special character will be used as the 16th character. This is a space if the character set selected with [AT+CSCS](#) is 'GSM', or 'E400' if the character set is 'UCS2'.

Due to time constraints on the necessary evaluation of the phonebook, this parameter may show a default value in early call phases (e.g. for [<stat>](#)= "dialing", "incoming" or "alerting"), even if a phonebook entry is present for the number concerned.

Note

- Teleservices other than voice, data, fax are not fully supported by ME. They are used only in connection with the handling for [AT+CSNS](#), and may therefore occur in parameter [<mode>](#) for mobile terminated calls.

7.22 AT^SLCC Siemens defined command to list current calls of ME

AT^SLCC covers essentially the same information as GSM 07.07 command AT+CLCC, with the following additions:

- The execute command response contains an additional parameter `<traffic channel assigned>` indicating whether the call has been assigned a traffic channel by the network (transmission of data or inband information is possible).
- The additional write command allows to activate Event reporting for the list of current calls. If event reporting is active for an interface, a call status transition (cf. [Call Status Information](#)) and (if desired) the assignment of a traffic channel will generate an event report indication to this interface. In order to receive this event report as an URC, the URC presentation mode for this interface has to be configured with [AT+CMER](#).
The frequency of event report generation can be configured with AT command [AT^SCFG](#). Refer to [Call Status Information](#) for further detail on the configuration options.
- The additional read command allows to determine the event reporting mode `<n>` which indicates whether the interface receives event report indications for the list of current calls. Mind that the URC will be displayed only if the URC presentation mode for the interface concerned has been configured with [AT+CMER](#).

Syntax

Test Command	AT^SLCC=?																				
Response(s)	OK																				
Read Command	AT^SLCC?																				
Response(s)	^SLCC: <code><n></code> OK																				
Exec Command	AT^SLCC																				
Response(s)	[^SLCC: <code><idx></code> , <code><dir></code> , <code><stat></code> , <code><mode></code> , <code><empty></code> , <code><traffic channel assigned></code> [, <code><number></code> , <code><type></code> [, <code><alpha></code>]]] [^SLCC: <code><idx></code> , <code><dir></code> , <code><stat></code> , <code><mode></code> , <code><empty></code> , <code><traffic channel assigned></code> [, <code><number></code> , <code><type></code> [, <code><alpha></code>]]] [^SLCC:...] OK ERROR +CME ERROR																				
Write Command	AT^SLCC= <code>[<n>]</code>																				
Response(s)	OK ERROR +CME ERROR: <code><err></code>																				
Reference(s)	<table border="1"> <thead> <tr> <th>PIN</th> <th>ASC0</th> <th>ASC1</th> <th>USB</th> <th>MUX1</th> <th>MUX2</th> <th>MUX3</th> <th>Charge</th> <th>→</th> <th>Last</th> </tr> </thead> <tbody> <tr> <td>●</td> <td>●</td> <td>●</td> <td>●</td> <td>●</td> <td>●</td> <td>●</td> <td>○</td> <td>○</td> <td>○</td> </tr> </tbody> </table>	PIN	ASC0	ASC1	USB	MUX1	MUX2	MUX3	Charge	→	Last	●	●	●	●	●	●	●	○	○	○
PIN	ASC0	ASC1	USB	MUX1	MUX2	MUX3	Charge	→	Last												
●	●	●	●	●	●	●	○	○	○												
Siemens																					

Unsolicited Result Code

Unsolicited Call Status information

if the list of current calls is empty:

^SLCC:

if one or more calls are currently in the list:

```
^SLCC: <idx>, <dir>, <stat>, <mode>, <empty>, <traffic channel assigned>[,  
<number>, <type>[, <alpha>]]  
[^SLCC: <idx>, <dir>, <stat>, <mode>, <empty>, <traffic channel assigned>[,  
<number>, <type>[, <alpha>]]]  
[... ]  
^SLCC:
```

URC "**^SLCC**" displays the list of current calls as displayed with the execute command **AT^SLCC**. The list is displayed in the state it has at the time of display, not in the state it had when the signal was generated.

The URC's occurrence indicates call status changes for any of the calls in the list of current calls.

Please refer to [Call Status Information](#) and **AT^SCFG** for further information about the configuration of this URC.

Event reporting can be enabled separately for each interface. Interface settings are saved with **AT&W** and can be displayed with **AT&V**. Additionally, The URC presentation mode for the interface must be configured with **AT+CMER**.

Depending on the value of **AT^SCFG** setting **<sucs>**, Indicator "**^SLCC**" will be issued (if configured with write command **AT^SLCC** and **AT+CMER**)

- when a state transition ends in state "active" or in state "unknown" (if **AT^SCFG** setting **<sucs>**="restricted")
- when any state transition (including transitions beginning or ending in state "unknown") occurs in the list of active calls, or when a traffic channel is established (if **AT^SCFG** setting **<sucs>**="verbose").

If multiple displays of identical list configurations occur, this happens because of short intermediate states of the list, that have already been overridden by new transitions and states. Thus, it is guaranteed that the configuration displayed is always the current configuration at the time of the last display.

The list of active calls displayed with this URC will always be terminated with an empty line preceded by prefix "**^SLCC:** ", in order to indicate the end of the list.

Command Description

The read command returns an indication whether event reporting is active for the current interface.

The exec command returns a list of current calls of ME. If command is successful, but no calls are available, no information response is sent to TE.

Use the write command to activate or deactivate event reporting for URC "**^SLCC**". Event reporting can be enabled separately for each interface. Interface settings are saved with **AT&W** and can be displayed with **AT&V**.

Parameter Description

<idx>^(num)

call identification number as described in GSM02.30 subclause 4.5.5.1; this number can be used in **AT+CHLD** command operations

<n>^{(num)(&W)(&V)}

[0] ^(&F)	presentation of URC " ^SLCC " disabled
1	presentation of URC " ^SLCC " enabled

<dir>^(num)

0	mobile originated call (MOC)
1	mobile terminated call (MTC)

<stat>^(num)

state of the call

0	active
1	held
2	dialing (MOC)
3	alerting (MOC)
4	incoming (MTC)
5	waiting (MTC)
6	terminating: The call is not active anymore, but inband information is still available.
7	dropped: The call has been suspended by the network, but may be resumed later.

<mode>^(num)

bearer/teleservice

0	voice
1	data
2	fax
3	voice followed by data, voice mode (only in connection with single numbering scheme AT+CSNS)
4	alternating voice/data, voice mode (only in connection with single numbering scheme AT+CSNS)
5	alternating voice/fax, voice mode (only in connection with single numbering scheme AT+CSNS)
6	voice followed by data, data mode (only in connection with single numbering scheme AT+CSNS)
7	alternating voice/data, data mode (only in connection with single numbering scheme AT+CSNS)
8	alternating voice/fax, fax mode (only in connection with single numbering scheme AT+CSNS)
9	unknown

<mpty>^(num)

0	call is not one of multiparty (conference) call parties
1	call is one of multiparty (conference) call parties

<traffic channel assigned>^(num)

0	No traffic channel is available to the call
1	mobile has been assigned a traffic channel. It is now possible to send or receive inband information, e.g. to send DTMF tones (cf. AT+VTS), or to receive network announcements.

<number>^(str)

phone number in format specified by [<type>](#)

<type>^(num)

type of address octect

145 dialing string <number> includes international access code character '+'
129 otherwise

<alpha>^(str)

Alphanumeric representation of <number> corresponding to the entry found in phonebook; used character set should be the one selected with command AT+CSCS (Select TE Character Set).

The maximum displayed length of <alpha> is 16 characters. If <alpha> has more than 16 characters, only the first 15 characters will be displayed. To indicate an overflow, a special character will be used as the 16th character. This will be a space if the character set selected with AT+CSCS is 'GSM', or 'E400' if the character set is 'UCS2'.

Due to time constraints on the necessary evaluation of the phonebook, this parameter may show a default value during early call phases (e.g. for <stat>= "dialing", "incoming" or "alerting"), even if a phonebook entry is present for the number concerned.

Notes

- Teleservices other than voice, data, fax are not fully supported by ME. They are used only in connection with the handling for AT+CSNS, and may therefore occur in parameter <mode> for mobile terminated calls.
- If a URC "^SLCC" in verbose mode (see AT^SCFG) has been buffered while the interface was in dedicated mode (depending on the settings of AT+CMER parameter <bfr>), each buffered event indicator will be output as a separate URC after the interface returns to idle mode.
However, the output will deliver the list of current calls in the "current" state (at the time when the output is generated), possibly leading to multiple displays of identical list configurations.
- Some parameters of AT command AT+CHLD, as well as some situations where the call status in the network changes very quickly (e.g. the transition between <stat>= "unknown", "dialing" and "alerting" for a call to a reachable subscriber within the registered network) may lead to quasi-simultaneous changes to the states of one or several calls in the list, possibly leading to multiple displays of identical list configurations.
- If multiple displays of identical list configurations occur, this happens because of intermediate states of the list, that have already been overridden by new transitions and states. Thus, it is guaranteed that the configuration displayed in such cases is the current configuration at the time of the last display.
- It is adviseable to receive URC "^SLCC" on an interface that is not used for call initiation, if verbose output is configured. If only voice calls are expected, a setting of AT^SM20= 0 may be used alternatively in order to keep the call from blocking the interface.

Examples

EXAMPLE 1

```

^SYSSTART
at+cpin=9999
OK

+CREG: 2

+CREG: 1, '0145', '0016'
at^sm20=0

OK
atd'1234567';
OK

```

We are now registered
command "ATD" for an outgoing voice call will terminate immediately with response "OK"

We start a voice call.
"OK" response is issued immediately because of setting "^SM20=0"

^SLCC: 1,0,2,0,0,0,'1234567',129,'Called Party'	MO call starts, paging B-party
^SLCC: ^SLCC: 1,0,2,0,0,1,'1234567',129,'Called Party'	End of current list Traffic channel established, network may now transmit network announcements, ME may now transmit DTMF tones.
^SLCC: ^SLCC: 1,0,3,0,0,1,'1234567',129,'Called Party'	End of current list Call is now ringing at B-Party
^SLCC: ^SLCC: 1,0,0,0,0,1,'1234567',129,'Called Party'	End of current list B-Party has accepted the call, connection estab- lished
^SLCC: atd23456; OK	End of current list We start a second voice call. "OK" response is issued immediately because another call is already active (cf. ATD)
^SLCC: 1,0,1,0,0,0,'1234567',129,'Called Party'	The active call is automatically put on hold, triggering the display of the list
^SLCC: 2,0,2,0,0,1,"23456",129	The second call has already started before the indi- cation for the held call could be displayed
^SLCC: ^SLCC: 1,0,1,0,0,0,'1234567',129,'Called Party'	End of current list The identical list is displayed again, triggered by the start of the second voice call
^SLCC: 2,0,2,0,0,1,"23456",129	The status of the second list entry has already been displayed with the previous URC
^SLCC: ^SLCC: 1,0,1,0,0,0,'1234567',129,'Called Party'	End of current list The held call doesn't change status right now
^SLCC: 2,0,3,0,0,1,"23456",129	The second call is now alerting the B-Party
^SLCC: ^SLCC: 1,0,0,0,0,1,'1234567',129,'Called Party'	End of current list The held call doesn't change status right now
^SLCC: NO CARRIER	End of current list: the B-Party of the second call has not accepted the call in time, the second call has ended.
^SLCC: NO CARRIER	The second call has ended list is now empty: B-Party has ended the first call The first call has ended

EXAMPLE 2

^SLCC: 1,1,4,0,0,1,'1234567',129	Incoming call is signalled. Display is triggered by the incoming call, but the cur- rent status of the call at the time of display already comprises an active traffic channel.
^SLCC: RING	End of current list Incoming call is signalled.
^SLCC: 1,1,4,0,0,1,'1234567',129	The incoming call had a traffic channel assigned from the start. This second identical display is triggered by the traf- fic channel assignment. Since the traffic channel was already indicated in the previous URC, both instances of the URC contain identical information.

^SLCC:	End of current list
RING	Incoming call is signalled.
ata	Incoming call is accepted.
OK	call is established.
^SLCC: 1,1,0,0,0,1,'1234567',129	The call is now active.
^SLCC:	End of current list
ath	Hang up the call.
OK	hang up complete.
^SLCC:	The list of current calls is empty again

7.23 AT+CR Service reporting control

AT+CR configures the TA whether or not to transmit an intermediate result code +CR: <serv> to TE when a call is being set up.

Setting the value of <mode> to 1 may lead to connection failure, if the application (e.g. WinFax) waits for default result code/URC.

Syntax

<p>Test Command</p> <p>AT+CR=?</p> <p>Response(s)</p> <p>+CR: (list of supported<mode>s)</p> <p>OK</p> <p>ERROR</p>	
<p>Read Command</p> <p>AT+CR?</p> <p>Response(s)</p> <p>+CR: <mode></p> <p>OK</p> <p>ERROR</p>	
<p>Write Command</p> <p>AT+CR=<mode></p> <p>Response(s)</p> <p>OK</p> <p>ERROR</p>	
<p>Reference(s)</p> <p>GSM 07.07</p>	<p>PIN ASC0 ASC1 USB MUX1 MUX2 MUX3 Charge → Last</p> <p>● ● ● ● ● ● ○ ● ○</p>

Intermediate Result Code

If enabled, an intermediate result code is transmitted during connect negotiation when the TA has determined the speed and quality of service to be used, before any error control or data compression reports are transmitted, and before any final result code (e.g. CONNECT) appears.

+CR: <serv>

Parameter Description

<mode> ^{(num)(&W)(&V)}	
0(&F)	Disable
1	Enable
<serv> ^(str)	
“REL ASYNC“	Asynchronous non-transparent
“GPRS“	GPRS

7.24 AT+CRC Set Cellular Result Codes for incoming call indication

The **AT+CRC** command controls whether or not the extended format of incoming call indication is used. Setting the value of `<mode>` to 1 may lead to connection failure, if the application (e.g. WinFax) waits for default result code/URC.

Syntax

<p>Test Command</p> <p>AT+CRC=?</p> <p>Response(s)</p> <p>+CRC: (list of supported<mode>s)</p> <p>OK</p> <p>ERROR</p>	
<p>Read Command</p> <p>AT+CRC?</p> <p>Response(s)</p> <p>+CRC: <mode></p> <p>OK</p> <p>ERROR</p>	
<p>Write Command</p> <p>AT+CRC=[<mode>]</p> <p>Response(s)</p> <p>OK</p> <p>ERROR</p>	
<p>Reference(s)</p> <p>GSM 07.07</p>	

Unsolicited Result Code

When enabled, an incoming call is indicated to the TE with unsolicited result code +CRING: `<type>` instead of the normal RING.

+CRING: `<type>`

Parameter Description

<code><mode></code> ^{(num)(&W)(&V)}	
[0] ^(&F)	Disable extended format
1	Enable extended format
<code><type></code> ^(str)	
“REL ASYNC“	Asynchronous non-transparent
“FAX“	Facsimile
“VOICE“	Voice
“GPRS“	<code><PDP_type></code> , <code><PDP_addr></code> [, [<code><L2P></code>][, <code><APN></code>]] GPRS network request for PDP context activation

7.25 AT+CSNS Single Numbering Scheme

Syntax

<p>Test Command</p> <pre>AT+CSNS=?</pre> <p>Response(s)</p> <pre>+CSNS: (list of supported<mode>s) OK</pre>	
<p>Read Command</p> <pre>AT+CSNS?</pre> <p>Response(s)</p> <pre>+CSNS: <mode> OK</pre>	
<p>Write Command</p> <pre>AT+CSNS=[<mode>]</pre> <p>Response(s)</p> <pre>OK ERROR +CME ERROR</pre>	
<p>Reference(s)</p> <p>GSM 07.07</p>	

Command Description

The [AT+CSNS](#) command enables the ME to accept incoming calls when no bearer capability information is provided with the call, e.g. single numbering scheme calls or calls originating from analog devices.

Parameter Description

<code><mode></code> ^(num)	
<code>[0]</code> ^(D)	Voice: Each call received without bearer element is assumed to be speech
2	Fax: Each call received without bearer element is assumed to be an incoming fax.
4	Data: Each call received without bearer element is assumed to be a data call. Please take into account that the bearer service parameters set with AT+CBST apply to all data calls including those received without bearer capability.

Notes

- The command must be set before the call comes. By default, when you do not modify the settings, all calls received without bearer element are assumed to be voice.
- The setting will be automatically saved when you power down the GSM engine with [AT^SMSO](#), provided that PIN authentication has been done. This value will be restored when PIN authentication is done again.

7.26 AT^SCNI List Call Number Information

Syntax

<p>Test Command</p> <pre>AT^SCNI=?</pre> <p>Response(s)</p> <pre>OK</pre>	<p>Exec Command</p> <pre>AT^SCNI</pre> <p>Response(s)</p> <pre>^SCNI: <id>₁[,<cs>[,<number>,<type>]] ^SCNI: <id>₂[,<cs>[,<number>,<type>]] [...] OK ERROR +CME ERROR: <err></pre>																				
<p>Reference(s)</p> <p>SIEMENS</p>	<table border="1"> <tr> <td>PIN</td> <td>ASC0</td> <td>ASC1</td> <td>USB</td> <td>MUX1</td> <td>MUX2</td> <td>MUX3</td> <td>Charge</td> <td>✈</td> <td>Last</td> </tr> <tr> <td>●</td> <td>●</td> <td>●</td> <td>●</td> <td>●</td> <td>●</td> <td>●</td> <td>○</td> <td>○</td> <td>○</td> </tr> </table>	PIN	ASC0	ASC1	USB	MUX1	MUX2	MUX3	Charge	✈	Last	●	●	●	●	●	●	●	○	○	○
PIN	ASC0	ASC1	USB	MUX1	MUX2	MUX3	Charge	✈	Last												
●	●	●	●	●	●	●	○	○	○												

Command Description

TA returns a list of current calls of ME.

Parameter Description

<p><id>^(num)</p> <p>call identification number as described in GSM 02.30[19] subclause 4.5.5.1; this number can be used in AT+CHLD command operations</p> <p>1...7</p>						
<p><cs>^(num)</p> <p>Call status of respective call number (first parameter)</p> <table border="1"> <tr> <td>0</td> <td>call hold</td> </tr> <tr> <td>1</td> <td>call in progress</td> </tr> <tr> <td>2</td> <td>waiting call</td> </tr> </table>	0	call hold	1	call in progress	2	waiting call
0	call hold					
1	call in progress					
2	waiting call					
<p><number>^(str)</p> <p>string type phone number in format specified by <type></p>						
<p><type>^(num)</p> <p>type of address octet in integer format; 145 when dialling string includes international access code character "+", otherwise 129</p>						

Note

- See also GSM 07.07: [AT+CLCC](#)

7.27 AT^SLCD Display Last Call Duration

Syntax

Test Command	
AT^SLCD=?	
Response(s)	
OK	
ERROR	
+CME ERROR	
Exec Command	
AT^SLCD	
Response(s)	
^SLCD: <time>	
OK	
ERROR	
+CME ERROR	
Reference(s)	
SIEMENS	
	PIN ASC0 ASC1 USB MUX1 MUX2 MUX3 Charge  Last
	<input type="checkbox"/> <input type="checkbox"/> <input type="checkbox"/> <input type="checkbox"/> <input type="checkbox"/> <input type="checkbox"/> <input type="checkbox"/> <input type="checkbox"/> <input type="checkbox"/> <input type="checkbox"/> <input type="checkbox"/>

Command Description

TA returns last call duration or current call duration.

Parameter Description

<time> ^(str)
Format is "hh:mm:ss", where characters indicate hours, minutes, seconds; E.g. 22:10:00 "22:10:00" Max value is 9999:59:59

Note

- The proper working of that command is network dependant.

7.28 AT^STCD Display Total Call Duration

Syntax

Test Command	
AT^STCD=?	
Response(s)	
OK	
ERROR	
+CME ERROR	
Exec Command	
AT^STCD	
Response(s)	
^STCD: <time>	
OK	
ERROR	
+CME ERROR	
Reference(s)	
SIEMENS	
	PIN ASC0 ASC1 USB MUX1 MUX2 MUX3 Charge  Last
	<input checked="" type="checkbox"/> <input checked="" type="checkbox"/> <input checked="" type="checkbox"/> <input checked="" type="checkbox"/> <input checked="" type="checkbox"/> <input checked="" type="checkbox"/> <input checked="" type="checkbox"/> <input checked="" type="checkbox"/> <input type="checkbox"/> <input checked="" type="checkbox"/> <input type="checkbox"/>

Command Description

TA returns total call duration (accumulated duration of all calls).

Parameter Description

<time> ^(str)
Format is "hh:mm:ss", where characters indicate hours, minutes, seconds; E.g. 22:10:00 "22:10:00" Max value is 9999:59:59

Notes

- The Total Call Duration will not be reset by power off or other means.
- The proper working of that command is network dependant and only for MO calls.

7.29 ATP Select pulse dialing

Syntax

Exec Command										
ATP										
Response(s)										
OK										
Reference(s)	PIN	ASC0	ASC1	USB	MUX1	MUX2	MUX3	Charge	✈	Last
V.250	<input type="radio"/>	<input checked="" type="radio"/>	<input type="radio"/>	<input checked="" type="radio"/>	<input checked="" type="radio"/>	<input type="radio"/>	<input type="radio"/>	<input type="radio"/>	<input type="radio"/>	<input type="radio"/>

Note

- No effect for GSM.

7.30 ATT Select tone dialing

Syntax

Exec Command										
ATT										
Response(s)										
OK										
Reference(s)	PIN	ASC0	ASC1	USB	MUX1	MUX2	MUX3	Charge	✈	Last
V.250	<input type="radio"/>	<input checked="" type="radio"/>	<input type="radio"/>	<input checked="" type="radio"/>	<input checked="" type="radio"/>	<input type="radio"/>	<input type="radio"/>	<input type="radio"/>	<input type="radio"/>	<input type="radio"/>

Note

- No effect for GSM.

8. Network Service Commands

The AT Commands described in this chapter are related to various network services. More commands related to this area can be found in Chapter 9., [Supplementary Service Commands](#).

8.1 AT+COPN Read operator names

The [AT+COPN](#) command returns the list of operator names from the ME. Each operator code `<numericn>` that has an alphanumeric equivalent `<alphan>` in the ME memory is returned. See also: [AT^SPLM](#).

Syntax

<p>Test Command</p> <pre>AT+COPN=?</pre> <p>Response(s)</p> <pre>OK ERROR +CME ERROR</pre>	<p>Exec Command</p> <pre>AT+COPN</pre> <p>Response(s)</p> <pre>+COPN: <numericn>, <alphan> +COPN: ... OK ERROR +CME ERROR</pre>
<p>Reference(s)</p> <pre>GSM 07.07</pre>	<p>PIN ASC0 ASC1 USB MUX1 MUX2 MUX3 Charge → Last</p> <p>● ● ● ● ● ● ● ○ ● ○</p>

Parameter Description

`<numericn>`^(str)

Operator in numeric format; GSM location area identification number.

`<alphan>`^(str)

Operator in long alphanumeric format; can contain up to 16 characters.

8.2 AT+COPS Operator Selection

AT+COPS queries the present status of the TC65's network registration and allows to determine whether automatic or manual network selection shall be used.

Additional service is available with **AT^SOPS**.

Three operator selection modes are available:

- **Automatic**
TC65 searches for the home operator automatically. If successful the TC65 registers to the home network. If the home network is not found, TC65 goes on searching. If a permitted operator is found, TC65 registers to this operator.
If no operator is found the TC65 remains unregistered.
- **Manual**
Desired operator can be determined using the **AT+COPS** write command. If the operator is found, TC65 registers to it immediately. If the selected operator is forbidden, the TC65 remains unregistered.
- **Manual/automatic**
TC65 first tries to find the operator determined via **AT+COPS** write command. If the TC65 fails to register to this operator, then it starts to select another (permitted) operator automatically.

The **AT+COPS** test command lists sets of four parameters, each representing an operator present in the network. A set consists of

- an integer indicating the availability of the operator,
- long alphanumeric format of the operator's name and
- numeric format representation of the operator.

Any of the parameters may be unavailable and will then be an empty field (,).

The list of operators comes in the following order: Home network, networks referenced in SIM and other networks.

The operator list is followed by a list of the supported **<mode>**s and **<format>**s. These lists are delimited from the operator list by two commas.

If the test command is used during an ongoing GPRS transfer, traffic will be interrupted for up to one minute.

The **AT+COPS** read command returns the current **<mode>** and the currently selected operator. If no operator is selected, **<format>** and **<oper>** are omitted.

The **AT+COPS** write command forces an attempt to select and register to the GSM network operator (see note below). If the selected operator is not available, no other operator will be selected (except **<mode>**=4). The selected operator name **<format>** will apply to further read commands, too.

Command settings are effective over all serial interfaces of the TC65.

Syntax

Test Command

```
AT+COPS=?
```

Response(s)

```
+COPS: [list of present operators (<opStatus>, long alphanumeric <oper>s,,numeric <oper>s) ], , (list of supported <mode>s), (list of supported <format>s)
```

```
OK
```

```
ERROR
```

```
+CME ERROR: <err>
```

Read Command

```
AT+COPS?
```

Response(s)

```
+COPS: <mode>[, <format>[, <oper>]]
```

```
OK
```

```
ERROR
```

```
+CME ERROR: <err>
```

```

Write Command
AT+COPS=<mode>[, <format>[, <oper>]]
Response(s)
OK
ERROR
+CME ERROR: <err>
Reference(s)
GSM 07.07
PIN ASC0 ASC1 USB MUX1 MUX2 MUX3 Charge → Last

```

Parameter Description

<opStatus>^(num)

Status

0	Unknown
1	Operator available
2	Current operator
3	Operator forbidden

<oper>^(str)

Operator

If test command: Operator name in long alphanumeric format and numeric format.
If read command: Operator name as per <format>.
If write command: Operator name in numeric format.

<mode>^{(num)&(V)}

Parameter values 0 and 1 are stored non-volatile in the TC65.

0 ^(D)	Automatic mode; <oper> field is ignored.
1	Manual operator selection Write command requires <oper> in numeric format, i.e. <format> shall be 2. Read command returns the current <mode> and the currently selected <oper>. If no operator is selected, <format> and <oper> are omitted.
2	Manually deregister from network and remain unregistered until <mode>=0 or 1 or 4 is selected.
3	Set only <format> (for AT+COPS read command).
4	Automatic / manual selection; if manual selection fails, automatic mode (<mode>=0) is entered (<oper> field will be present).

<format>^{(num)&(W)&(V)}

0 ^(&F)	Long alphanumeric format of <oper>. Can be up to 16 characters long.
2	Numeric format of <oper>. This is the GSM Location Area Identification (LAI) number, which consists of the 3-digit Mobile Country Code (MCC) plus the 2- or 3-digit Mobile Network Code (MNC).

Note

- It is not recommended to use the [AT+COPS](#) command before passing the CHV (card holder verification) / SIM PIN1 verification. This is because after PIN1 verification the module will automatically try to register to the network as though [AT+COPS](#) were 0, regardless of the settings done before with or without SIM, such as [AT+COPS=2](#) which remains unchanged. Also, the test command should only be used after PIN1 authentication.

8.3 AT^SOPS Extended Operator Selection

[AT^SOPS](#) queries the present status of the TC65's network registration. Since basic operator selection services are available with [AT+COPS](#) this command uses the methods of the Enhanced Operator Name String (EONS) specification while handling operator name strings. Additional [EONS related information](#) is available with [AT^SIND](#).

[AT^SOPS](#) test command lists sets of five parameters, each representing an operator present in the network. A set consists of

1. an integer indicating the availability of the operator,
2. specification of the source of the operator name `<eonsOperator>`,
3. operator name according to EONS Table,
4. Service Provider Name from the SIM Service Table and
5. numeric format representation of the operator.

Any of the parameters may be unavailable and will then be an empty field (,).

The list of operators comes in the following order: Home network, networks referenced in SIM and other networks.

After the operator list the TC65 returns lists of supported `<mode>`s and `<format>`s. These lists are delimited from the operator list by two commas.

If the test command is used while an ongoing GPRS transfer, traffic will be interrupted for up to one minute.

Command settings are effective over all serial interfaces of the TC65.

Syntax

Test Command

```
AT^SOPS=?
```

Response(s)

```
^SOPS:[list of present operator( <opStatus>, <eonsType>, <eonsOperator>, <servProvider>, <opName>)]s, , (list of supported <mode>)]s, (list of supported <format>)]s
OK
ERROR
+CME ERROR: <err>
```

Reference(s)

SIEMENS

PIN
ASC0
ASC1
USB
MUX1
MUX2
MUX3
Charge
→
Last

Parameter Description

<code><opStatus></code> ^(num)	
Status	
0	unknown
1	operator available
2	current operator
3	operator forbidden

`<eonsType>`^(num)
Specification of the source of the operator name `<eonsOperator>`. Details of [EONS-supplied operator name types](#) are available at [AT^SIND](#).

<eonsOperator>

Operator name; format depends on the source of the operator name, specified by <eonsType>.

<servProvider>^(str)

Service Provider Name according to setting of Service No. 17 in the SIM Service Table (EF_{SST}).

<opName>

Operator

Operator name in numerical presentation contains the GSM Location Area Identification (LAI) number, which consists of the 3-digit Mobile Country Code (MCC) plus the 2- or 3-digit Mobile Network Code (MNC). Parameter is stored non-volatile to the SIM.

<mode>^(num)

Parameter is not applicable.

<format>^(num)

Parameter is not applicable.

Note

- The AT^SOPS Test command is only accepted by the module after a valid pin has been entered.

8.4 AT+CREG Network registration

The **AT+CREG** command serves to verify the network registration status of the ME. For this purpose two types of URCs are available.

The **AT+CREG** read command returns the URC presentation mode **<n>** and an integer **<stat>** that shows the registration status of the ME. The location information elements **<lac>** and **<ci>** are returned only when **<n>=2** and ME is registered to the network.

Syntax

<p>Test Command</p> <pre>AT+CREG=?</pre> <p>Response(s)</p> <pre>+CREG: (list of supported<n>s) OK</pre>	
<p>Read Command</p> <pre>AT+CREG?</pre> <p>Response(s)</p> <pre>+CREG: <n>, <stat>[, <lac>, <ci>] OK ERROR +CME ERROR: <err></pre>	
<p>Write Command</p> <pre>AT+CREG=[<n>]</pre> <p>Response(s)</p> <pre>OK ERROR +CME ERROR: <err></pre>	
<p>Reference(s)</p> <pre>GSM 07.07</pre>	

Unsolicited Result Codes

URC 1

If **<n>=1** and there is a change in the ME network registration status:

```
+CREG: <stat>
```

URC 2

If **<n>=2** and there is a change in the ME network registration status or a change of the network cell:

```
+CREG: <stat>[, <lac>, <ci>]
```

Parameter Description

<n> ^{(num)(&W)(&V)}	
[0] ^(&F)	Disable +CREG URC
1	Enable URC +CREG:<stat> to report status of network registration
2	Enable URC +CREG:<stat>[,<lac>,<ci>] to report status of network registration including location information. Optional parameters <lac> and <ci> will not be displayed during calls or if these values have not changed since last AT+CREG read command or since last indication by +CREG URC.

<stat>^(num)&V)

0	<p>Not registered, ME is currently not searching for new operator There is a technical problem. User intervention is required. Yet, emergency calls can be made if any network is available. Probable causes:</p> <ul style="list-style-type: none">• No SIM card available• No PIN entered• No valid Home PLMN entry found on the SIM
1	<p>Registered to home network</p>
2	<p>Not registered, but ME is currently searching for a new operator. The ME searches for an available network. Failure to log in until after more than a minute may be due to one of the following causes:</p> <ul style="list-style-type: none">• No network available or insufficient Rx level.• The ME has no access rights to the networks available.• Networks from the SIM list of allowed networks are around, but login fails due to one of the following reasons:<ul style="list-style-type: none">- #11 ... PLMN not allowed- #12 ... Location area not allowed- #13 ... Roaming not allowed in this location area <p>After this, the search will be resumed (if automatic network search is enabled).</p> <ul style="list-style-type: none">• The Home PLMN or an allowed PLMN is available, but login is rejected by the cell (reasons: Access Class or LAC). <p>If at least one network is available, emergency calls can be made.</p>
3	<p>Registration denied</p> <ul style="list-style-type: none">• If automatic network search is enabled: Authentication or registration fails after Location Update Reject due to one of the following causes:<ul style="list-style-type: none">- #2 ... IMSI unknown at HLR- #3 ... Illegal MS- #6 ... Illegal ME <p>Either the SIM or the MS or the ME are unable to log into any network. User intervention is required. Emergency calls can be made, if any network is available.</p> <ul style="list-style-type: none">• Only if manual network search is enabled: Manual registration fails after Location Update Reject due to the following causes:<ul style="list-style-type: none">- #2 ... IMSI unknown at HLR- #3 ... Illegal MS- #6 ... Illegal ME- #11 ... PLMN not allowed- #12 ... Location area not allowed- #13 ... Roaming not allowed in this location area <p>No further attempt is made to search or log into a network. Emergency calls can be made if any network is available.</p>
4	<p>Unknown (not used)</p>
5	<p>Registered, roaming The ME is registered at a foreign network (national or international network)</p>

<lac>^(str)

Two byte location area code in hexadecimal format (e.g. "00C3" equals 193 in decimal).

<ci>^(str)

Two byte cell ID in hexadecimal format.

Example

AT+CREG=2	Activates extended URC mode.
OK	
AT+COPS=0	Forces ME to automatically search network operator.
OK	
+CREG: 2	URC reports that ME is currently searching.
+CREG: 1, "0145", "291A"	URC reports that operator has been found.

8.5 AT+CSQ Signal quality

The [AT+CSQ](#) execute command indicates the received signal strength `<rssi>` and the channel bit error rate `<ber>`.

Syntax

<pre>Test Command AT+CSQ=? Response(s) +CSQ: (list of supported<rssi>s), (list of supported<ber>s) OK</pre>	<pre>Exec Command AT+CSQ Response(s) +CSQ: <rssi>,<ber> OK</pre>
<pre>Reference(s) GSM 07.07</pre>	

Parameter Description

<code><rssi></code> ^(num)	
0	-113 dBm or less
1	-111 dBm
2..30	-109... -53 dBm
31	-51 dBm or greater
99	not known or not detectable

<code><ber></code> ^(num)	
0..7	as RXQUAL values in the table in GSM 05.08 section 8.2.4.
99	not known or not detectable

Note

- After using network related commands such as [AT+CCWA](#), [AT+CCFC](#), [AT+CLCK](#), users are advised to wait 3s before entering [AT+CSQ](#). This is recommended to be sure that any network access required for the preceding command has finished.

8.6 AT^SMONC Cell Monitoring

The AT^SMONC execute command delivers cell information containing 9 values from a maximum of 7 base stations. The first base station is the serving cell.

Syntax

<p>Test Command</p> <p>AT^SMONC=?</p> <p>Response(s)</p> <p>OK</p> <p>ERROR</p> <p>+CME ERROR</p>	<p>Exec Command</p> <p>AT^SMONC</p> <p>Response(s)</p> <p>^SMONC: <MCC>₁, <MNC>₁, <LAC>₁, <cell>₁, <BSIC>₁, <chann>₁, <RSSI>₁, <C1>₁, <C2>₁, <MCC>₂, <MNC>₂, <LAC>₂, <cell>₂, <BSIC>₂, <chann>₂, <RSSI>₂, <C1>₂, <C2>₂, ...</p> <p>OK</p> <p>ERROR</p> <p>+CME ERROR</p>
<p>Reference(s)</p> <p>SIEMENS, 3GPP TS 05.08</p>	

Parameter Description

<MCC>^(num)	
Mobile country code	
3 digits, e.g. 232	
000	Not decoded
<MNC>^(num)	
Mobile network code	
2 digits or 3 digits, e.g. 07 or 003	
000	Not decoded
<LAC>^(num)	
Location area code	
4 hexadecimal digits, e.g. 4EED	
0000	Not decoded
<cell>^(num)	
Cell identifier	
4 hexadecimal digits, e.g. 4EAF	
0000	Not decoded

<BSIC>^(num)

Base station identity code

2 digits, e.g. 32

00 Not decoded

<chann>^(num)

ARFCN (Absolute Frequency Channel Number)

0 Not decoded. In this case, all remaining parameters related to the same channel are neither decoded. For example, a non-existing cell appears as follows:
000,000,0000,0000,00,0,0,-,-

<RSSI>^(num)

Received signal level of the BCCH carrier (0..63). The indicated value is composed of the measured value in dBm plus an offset. This is in accordance with a formula specified in 3GPP TS 05.08

<C1>^(num)

Coefficient for base station reselection, e.g. 30. In dedicated mode, under certain conditions the parameter cannot be updated. In such cases a '-' is presented.

<C2>^(num)

Coefficient for base station reselection, e.g. 30. In dedicated mode, under certain conditions the parameter cannot be updated. In such cases a '-' is presented.

Note

- To some extent, the cell monitoring commands [AT^MONI](#), [AT^MONP](#) and [AT^SMONC](#) cover the same parameters. The receiving level, for example, can be queried with all three commands. Yet the resulting values may be slightly different, even though obtained over a time period of a few seconds. This is quite normal and nothing to worry about, as the cell information is permanently updated.

8.7 AT^MONI Monitor idle mode and dedicated mode

The [AT^MONI](#) command supplies information of the serving/dedicated cell. There are two ways to retrieve the information: once on request by using the execute command or automatically every [<period>](#) seconds by using the write command. To stop the periodic presentation type "AT" or "at".

Syntax

<p>Test Command</p> <p>AT^MONI=?</p> <p>Response(s)</p> <p>^MONI : (list of supported <period>s)</p> <p>OK</p>	
<p>Exec Command</p> <p>AT^MONI</p> <p>Response(s)</p> <p>See: Section 8.7.1, AT^MONI responses</p> <p>OK</p>	
<p>Write Command</p> <p>AT^MONI=<period></p> <p>Response(s)</p> <p>See: Section 8.7.1, AT^MONI responses</p> <p>OK</p> <p>ERROR</p> <p>+CME ERROR</p>	
<p>Reference(s)</p> <p>SIEMENS</p>	

Parameter Description

<p><period>^(num)</p> <p>Display period in seconds</p> <p>1...254</p>

Notes

- The two header lines (see Section [8.7.1, AT^MONI responses](#)) are output after every ten data lines.
- The length of following output lines exceeds 80 characters. Therefore a terminal program may draw a carriage return on a screen. However, this is not part of the response.
- If the ME is Java controlled, periodic retrieval of cell information using the write command [AT^MONI=<period>](#) is not supported. If periodic cell information is required simply repeat the execute commands at regular intervals.
- The parameters LAC and cell are presented as hexadecimal digits, the remaining parameters are composed of decimal digits.

- If the radio cell changes during a connection, the parameters PWR, RXLev and C1 of the 'Serving Cell' part cannot be updated under certain conditions and therefore, are displayed as "-" (for conditions see also [AT+CREG](#)). This is because the MS does not update the cell selection and reselection parameters since, in this mode, they are not relevant for operation. When the connection ends, and the mobile is back to IDLE mode, correct values will be given.
If the radio cell changes during a connection, it normally takes 1 or 2 seconds to update the parameters cell, NCC and BCC. Until the information is received from the new base station, the default values will be shown instead: cell="0000", NCC="-", BCC="-".
- If the BS supports frequency hopping during a connection, the dedicated channel (parameter chann) is not stable. This mode is indicated by chann = 'h'.
- To some extent, the cell monitoring command [AT^SMONC](#) covers the same parameters. The receiving level, for example, can be queried with both commands. Yet the resulting values may be slightly different, even though obtained over a time period of a few seconds. This is quite normal and nothing to worry about, as the cell information is permanently updated.
- For compatibility with earlier products and to support legacy applications, any input character may be used to stop the output in certain cases (depending on the settings of [AT+IPR](#) and [AT+CMUX](#)).

8.7.1 AT^MONI responses

ME is not connected:

a) ME is camping on a cell and registered to the network:

Serving Cell													I Dedicated channel							
chann	rs	dBm	MCC	MNC	LAC	cell	NCC	BCC	PWR	RXLev	C1	I	chann	TS	timAdv	PWR	dBm	Q	ChMod	
1013	21	-71	001	01	1001	0103	7	7	33	-105	33	I	No connection							

b) ME is camping on a cell but not registered to the network (only emergency call allowed):

Serving Cell													I Dedicated channel							
chann	rs	dBm	MCC	MNC	LAC	cell	NCC	BCC	PWR	RXLev	C1	I	chann	TS	timAdv	PWR	dBm	Q	ChMod	
1013	21	-71	001	01	1001	0103	7	7	33	-105	33	I	Limited Service							

c) ME camping on a cell, but searching for a better cell (cell reselection):

Serving Cell													I Dedicated channel							
chann	rs	dBm	MCC	MNC	LAC	cell	NCC	BCC	PWR	RXLev	C1	I	chann	TS	timAdv	PWR	dBm	Q	ChMod	
1013	21	-71	001	01	1001	0103	7	7	33	-105	33	I	Cell Reselection							

d) ME is searching and could not (yet) find a suitable cell:

Serving Cell													I Dedicated channel							
chann	rs	dBm	MCC	MNC	LAC	cell	NCC	BCC	PWR	RXLev	C1	I	chann	TS	timAdv	PWR	dBm	Q	ChMod	
													Searching							

ME is connected (Call in progress):

Serving Cell													I Dedicated channel						
chann	rs	dBm	MCC	MNC	LAC	cell	NCC	BCC	PWR	RXLev	C1	I	chann	TS	timAdv	PWR	dBm	Q	ChMod
1013	19	-76	001	01	1001	0103	7	7	33	-105	33	I	1015	1	0	5	-76	0	S_HR

Columns for Serving Cell:

Column	Description
chann	ARFCN (Absolute Frequency Channel Number) of the BCCH carrier
rs	RSSI value 0 - 63 (RSSI = Received signal strength indication)
dBm	receiving level of the BCCH carrier in dBm
MCC	Mobile Country Code (first part of the PLMN code)

Column	Description
MNC	Mobile Network Code (second part of the PLMN code)
LAC	location area code, see note below
cell	cell ID, see note below
NCC	PLMN colour code
BCC	base station colour code
PWR	maximal power level used on RACH channel in dBm
RXLev	minimal receiving level (in dBm) to allow registration
C1	coefficient for base station selection

Columns for Dedicated channel:

Column	Description
chann	ARFCN (Absolute Frequency Channel Number) of the TCH carrier Note: <chann> = h indicates frequency hopping.
TS	timeslot number
timAdv	timing advance in bits
PWR	current power level
dBm	receiving level of the traffic channel carrier in dBm
Q	receiving quality (0-7)
ChMod	channel mode (S_HR: Half rate, S_FR: Full rate, S_EFR: Enhanced Full Rate)

8.7.2 Service states

Depending on the service state, an additional textual output is generated (refer also to the response examples):

- 'Searching' - The MS is searching, but could not (yet) find a suitable cell. This output appears after restart of the MS or after loss of coverage.
- 'No connection' - The MS is camping on a cell and registered to the network. The service state is 'idle', i.e. there is no connection established or a dedicated channel in use.
- 'Cell Reselection' - The MS has not yet lost coverage but is searching for a better cell, since the cell reselection criterion is fulfilled.
- 'Limited Service' - The MS is camping on a cell but not registered to the network. Only emergency calls are allowed. The MS enters this state, for example, when
 - no SIM card is inserted, or PIN has not been given,
 - neither Home PLMN nor any other allowed PLMN are found,
 - registration request was not answered or denied by the network (use command AT+CREG to query the registration status),
 - authentication failed.

8.8 AT^MONP Monitor neighbour cells

The [AT^MONP](#) supplies information of up to six neighbour cells. There are two ways to retrieve the information: once on request by using the execute command or automatically every `<period>` seconds by using the write command. To stop the periodic presentation type "AT" or "at".

Syntax

<p>Test Command</p> <p>AT^MONP=?</p> <p>Response(s)</p> <p>^MONP: (list of supported <code><period></code>s)</p> <p>OK</p>	
<p>Exec Command</p> <p>AT^MONP</p> <p>Response(s)</p> <p>See: Section 8.8.1, AT^MONP responses</p> <p>OK</p>	
<p>Write Command</p> <p>AT^MONP=<code><period></code></p> <p>Response(s)</p> <p>See: Section 8.8.1, AT^MONP responses</p> <p>OK</p> <p>ERROR</p> <p>+CME ERROR</p>	
<p>Reference(s)</p> <p>SIEMENS</p>	

Parameter Description

<p><code><period></code>^(num)</p> <p>Display period in seconds</p> <p>1...254</p>
--

Notes

- Due to the fact that not all necessary information of the neighbour cells can be decoded during a connection, there are several constraints to be considered:
 - Only neighbour cells that have already been visible in IDLE mode will be further updated, as long as they are still included in the list.
 - Though new neighbour cells can be added to the list (e.g. due to handover), their C1 and C2 parameters cannot be displayed until the connection is released. In this case "-" is presented for C1 and C2.
 - To some extent, the cell monitoring command [AT^SMONC](#) covers the same parameters. The receiving level, for example, can be queried with both commands. Yet the resulting values may be slightly different, even though obtained over a time period of a few seconds. This is quite normal and nothing to worry about, as the cell information is permanently updated.
- For compatibility with earlier products and to support legacy applications, any input character may be used to stop the output in certain cases (depending on the settings of [AT+IPR](#) and [AT+CMUX](#)).
- If the ME is Java controlled, periodic retrieval of cell information using the write command [AT^MONP=<period>](#) is not supported. If periodic cell information is required simply repeat the execute commands at regular intervals.

8.8.1 AT^MONP responses

Response of AT^MONP (Example):

chann	rs	dBm	MCC	MNC	BCC	C1	C2
653	26	-84	262	07	0	22	22
660	20	-90	262	07	3	16	16
687	19	-91	262	07	1	15	15
678	14	-96	262	07	3	10	10
671	14	-96	262	07	1	10	10
643	10	-100	262	07	7	6	6

Column	Description
Chann	ARFCN (Absolute Radio Frequency Channel Number) of the BCCH carrier
rs	RSSI value 0 - 63 (RSSI = Received signal strength indication)
dBm	Receiving level in dBm
MCC	Mobile Country Code (first part of the PLMN code)
MNC	Mobile Network Code (second part of the PLMN code)
BCC	Base Station colour code
C1	cell selection criterion
C2	cell reselection criterion

8.9 AT^SMONG GPRS Monitor

The `AT^SMONG` command supplies GPRS specific cell information. There are two ways to retrieve the information: once on request by using the execute command or automatically every `<period>` seconds by using the write command. To stop the periodic presentation type "AT" or "at".

Syntax

<p>Test Command</p> <p>AT^SMONG=?</p> <p>Response(s)</p> <p>^SMONG: (list of supported <code><table></code>s), (list of supported <code><period></code>s)</p> <p>OK</p> <p>ERROR</p> <p>+CME ERROR</p>	
<p>Exec Command</p> <p>AT^SMONG</p> <p>Response(s)</p> <p>GPRS Monitor</p> <p>Cell Info Table (see: Section 8.9.1, AT^SMONG Cell Info Table)</p> <p>OK</p> <p>ERROR</p> <p>+CME ERROR</p>	
<p>Write Command</p> <p>AT^SMONG=<table>[, <period>]</p> <p>Response(s)</p> <p>^SMONG: GPRS Monitor</p> <p>Cell Info Table (see: Section 8.9.1, AT^SMONG Cell Info Table)</p> <p>OK</p> <p>ERROR</p> <p>+CME ERROR</p>	
<p>Reference(s)</p> <p>SIEMENS</p>	

Parameter Description

`<table>`^(num)

1	Cell Info Table
---	-----------------

`<period>`^(num)

Display period in seconds

If `<period>` is omitted the cell data will be presented only once on a single line (as if Execute command was issued).

If `<period>` is given, the cell data will be listed repeatedly on 10 data lines. Every 10th data line is followed by the header, simply to repeat the column titles.

1...100

Notes

- For compatibility with earlier products and to support legacy applications, often any input character will stop the periodic output of the write command. But since this applies only in certain cases (depending on the settings of `AT+IPR` and `AT+CMUX`), it is recommended to always use "at" or "AT".
- If the ME is Java controlled, periodic retrieval of cell information using the write command `AT^SMONG=<table>,<period>` is not supported. If periodic cell information is required simply repeat the execute commands at regular intervals.

8.9.1 AT^SMONG Cell Info Table

Example output for `AT^SMONG`:

```
GPRS Monitor
BCCH G PBCCH PAT MCC MNC NOM TA RAC # Cell #
0637 1 - 4 234 05 2 00 0B
```

Columns of the cell info table:

Column	Description
BCCH	ARFCN of BCCH carrier
G	GPRS status: - GPRS not supported 0 GPRS not attached 1 GPRS attached
PBCCH	If PBCCH is present, indication of ARFCN, else "-" or if Frequency Hopping is used "H"
PAT	Priority Access Threshold (GSM Rec. 04.08 / 10.5.2.37b) 0 Packet access is not allowed in the cell 1 Spare, shall be interpreted as "000" (packet access not allowed) 2 Spare, shall be interpreted as "000" (packet access not allowed) 3 Packet access is allowed for priority level 1 4 Packet access is allowed for priority level 1 to 2
MCC	Mobile Country Code
MNC	Mobile Network Code
NOM	Network Operation Mode (1...3)
TA	Timing Advance Value
RAC	Routing Area Code (as hexadecimal value)

8.10 AT^SALS Alternate Line Service

The `AT^SALS` command is designed to support Alternate Line Service. This allows the subscriber to use two voice numbers on the same SIM card (service requires a dual line SIM card).

The write command enables or disables the presentation of `<view>` and specifies the `<line>` used for outgoing calls. The read command returns the presentation mode of `<view>` and the currently selected `<line>`.

Syntax

<p>Test Command</p> <p><code>AT^SALS=?</code></p> <p>Response(s)</p> <p><code>^SALS: (list of supported <view>s), (list of supported <line>s)</code></p> <p>OK</p>	
<p>Read Command</p> <p><code>AT^SALS?</code></p> <p>Response(s)</p> <p><code>^SALS: <view>, <line></code></p> <p>OK</p> <p>ERROR</p>	
<p>Write Command</p> <p><code>AT^SALS=<view>[, <line>]</code></p> <p>Response(s)</p> <p>OK</p> <p>ERROR</p>	
<p>Reference(s)</p> <p>SIEMENS</p>	

Unsolicited Result Code

If switched on with `<view>=1`:

`^SALS: <line>`

Indicates the line used by an incoming call.

Parameter Description

<code><view></code> ^(num)	
Controls the presentation mode of the URC " <code>^SALS</code> " which indicates the line number used by an incoming call:	
<code>0(&F)</code>	Disables indication of the called line
<code>1</code>	Enables indication of the called line
<code><line></code> ^(num)	
Selects the line to be used for outgoing calls.	
<code>[1]</code>	ALS Line 1
<code>2</code>	ALS Line 2

Notes

- The selected `<line>` will be saved at non-volatile Flash memory and thus retained after Power Down.
- The `<line>` will be reset by `AT&F` and `ATZ` and afterwards saved at non-volatile memory too.
- The `<view>` will be reset after Power Down as well as by `ATZ` or `AT&F`.
- If a non ALS SIM is inserted, the `<line>` will be reset to line 1 as well.

Example

```
AT^SALS=1,1  
RING  
^SALS: 2
```

Line 1 has been selected for outgoing calls. "^SALS" URC is enabled.
You receive a notification that you have an incoming call on line 2.

8.11 AT^SHOM Display Homezone

The `AT^SHOM` returns the homezone state. The result is valid only, if network registration state `<stat>` is 1 (registered) (see `AT+CREG`).

The feature is available only for supported network operators (Viag, One2One, Orange and LCI) and requires a suitable SIM card. If the homezone feature is not supported by the network operator or SIM card, result is always 0.

Syntax

<p>Test Command</p> <pre>AT^SHOM=?</pre> <p>Response(s)</p> <pre>OK</pre>	
<p>Exec Command</p> <pre>AT^SHOM</pre> <p>Response(s)</p> <pre>^SHOM: <homezonestate> OK ERROR +CME ERROR: <err></pre>	
<p>Reference(s)</p> <p>SIEMENS</p>	

Parameter Description

<code><homezonestate></code> ^(num)	
0	ME is out of Homezone
1	ME is within the Homezone

8.12 AT^SPLM Read the PLMN list

The `AT^SPLM` execute command returns the list of operators from the ME. Each operator code `<numeric>` that has an alphanumeric equivalent `<alpha>` in the ME memory is returned. The list is sorted by operator codes. See also GSM 07.07: [AT+COFN](#), [AT+COPS](#)

Syntax

Test Command

`AT^SPLM=?`

Response(s)

OK

If error is related to ME functionality:

ERROR

+CME ERROR: `<err>`

Read Command

`AT^SPLM?`

Response(s)

`^SPLM: <range>`

OK

If error is related to ME functionality:

ERROR

+CME ERROR

Exec Command

`AT^SPLM`

Response(s)

`^SPLM: <numeric>, long <alpha>`

`^SPLM: [...]`

OK

If error is related to ME functionality:

ERROR

+CME ERROR

Write Command

`AT^SPLM=<index>`

Response(s)

`^SPLM: <numeric>, long <alpha>`

OK

If error is related to ME functionality:

ERROR

+CME ERROR

Reference(s)

GSM 07.07

PIN ASC0 ASC1 USB MUX1 MUX2 MUX3 Charge ↗ Last

● ● ● ● ● ● ● ○ ● ○

Command Description

The read command returns the range of operator indices supported by the ME.

The write command serves to read a single operator entry specified with `<index>`. The operator will be indicated by operator code `<numeric>` and name `<alpha>`.

Parameter Description

<numeric>^(str)

Operator in numeric form; GSM location area identification number

<alpha>^(str)

Operator in long alphanumeric format; can contain up to 16 characters

<range>^(num)

Range of supported operator indices

<index>^(num)

Index of the operator entry to be retrieved with the write command

Note

- If the ME is Java controlled, take into account that the AT Command API can handle responses up to a length of 1024 bytes. To avoid any longer responses it is recommended not to read the entire range of PLMN entries at a time.

8.13 AT^SPLR Read entry from the preferred operators list

The AT^SPLR write command returns used entries from the SIM list of preferred operators with <indexa> between <index1> and <index2>. If <index2> is not given, only entry at <index1> is returned. The test command returns the whole index range supported by the SIM.
See also GSM 07.07: AT+CPOL

Syntax

<p>Test Command</p> <pre>AT^SPLR=?</pre> <p>Response(s)</p> <pre>^SPLR:(list of supported) <indexa>s OK ERROR +CME ERROR: <err></pre>	<p>Write Command</p> <pre>AT^SPLR=<index1>[, <index2>]</pre> <p>Response(s)</p> <pre>^SPLR: <index1><oper> ^SPLR: <index2><oper> OK ERROR +CME ERROR: <err></pre>
<p>Reference(s)</p> <p>SIEMENS</p>	<p>PIN ASC0 ASC1 USB MUX1 MUX2 MUX3 Charge ↗ Last</p> <p>● ● ● ● ● ● ○ ● ○</p>

Parameter Description

<index1> ^(num)	Location number to start reading from
<index2> ^(num)	Location number where to stop reading
<indexa> ^(num)	Index range supported by the SIM card (between <index1> and <index2>)
<oper> ^(str)	Operator in numeric form; GSM location area identification number

8.14 AT^SPLW Write an entry to the preferred operators list

The AT^SPLW write command writes an entry to the SIM list of preferred operators at location number <index>. If <index> is given but <oper> is left out, the entry is deleted. An operator can be only once in the list. Test command returns the whole index range supported by the SIM. See also GSM 07.07: AT+CPOW

Syntax

<p>Test Command</p> <pre>AT^SPLW=?</pre> <p>Response(s)</p> <pre>^SPLW:(list of supported) <index>s OK ERROR +CME ERROR:</pre>	<p>Write Command</p> <pre>AT^SPLW=<index>[, <oper>]</pre> <p>Response(s)</p> <pre>OK ERROR +CME ERROR: <err></pre>																				
<p>Reference(s)</p> <p>SIEMENS</p>	<table border="1"> <tr> <td>PIN</td> <td>ASC0</td> <td>ASC1</td> <td>USB</td> <td>MUX1</td> <td>MUX2</td> <td>MUX3</td> <td>Charge</td> <td>✈</td> <td>Last</td> </tr> <tr> <td>●</td> <td>●</td> <td>●</td> <td>●</td> <td>●</td> <td>●</td> <td>●</td> <td>○</td> <td>●</td> <td>○</td> </tr> </table>	PIN	ASC0	ASC1	USB	MUX1	MUX2	MUX3	Charge	✈	Last	●	●	●	●	●	●	●	○	●	○
PIN	ASC0	ASC1	USB	MUX1	MUX2	MUX3	Charge	✈	Last												
●	●	●	●	●	●	●	○	●	○												

Parameter Description

<p><index>^(num)</p> <p>location number</p>
<p><oper>^(str)</p> <p>Operator in numeric format (GSM Location Area Identification number which consists of a 3-digit country code plus a 2- or 3-digit network code).</p>

9. Supplementary Service Commands

The AT Commands described in this chapter are related to the Supplementary Services offered by the GSM network.

9.1 AT+CACM Accumulated call meter (ACM) reset or query

Syntax

<p>Test Command</p> <p>AT+CACM=?</p> <p>Response(s)</p> <p>OK</p>	
<p>Read Command</p> <p>AT+CACM?</p> <p>Response(s)</p> <p>+CACM: <acm></p> <p>OK</p> <p>ERROR</p> <p>+CME ERROR: <err></p>	
<p>Write Command</p> <p>AT+CACM=[<passwd>]</p> <p>Response(s)</p> <p>OK</p> <p>ERROR</p> <p>+CME ERROR: <err></p>	
<p>Reference(s)</p> <p>GSM 07.07</p>	

Command Description

The read command returns the current ACM value.

The write command resets the Advice of Charge related to the accumulated call meter (ACM) value in SIM file EF(ACM). ACM contains the total number of home units for both the current and preceding calls.

Parameter Description

<acm>^(str)

Three bytes of the current ACM value in hexadecimal format (e.g. "00001E" indicates decimal value 30) 000000 - FFFFFFFF.

<passwd>^(str)

SIM PIN2

9.2 AT^SACM Advice of charge and query of ACM and ACMmax

Syntax

<p>Test Command</p> <pre>AT^SACM=?</pre> <p>Response(s)</p> <pre>^SACM:(list of supported <n>s) OK</pre>	
<p>Exec Command</p> <pre>AT^SACM</pre> <p>Response(s)</p> <pre>^SACM: <n>, <acm>, <acmMax> OK ERROR +CME ERROR: <err></pre>	
<p>Write Command</p> <pre>AT^SACM=<n></pre> <p>Response(s)</p> <pre>OK ERROR +CME ERROR: <err></pre>	
<p>Reference(s)</p> <p>SIEMENS</p>	

Unsolicited Result Code

+CCCM: <ccm>

When activated, an unsolicited result code is sent when the CCM value changes, but not more often than every 10 seconds.

Command Description

The execute command can be used to query the current mode of the Advice of Charge supplementary service, the SIM values of the accumulated call meter (ACM) and accumulated call meter maximum (ACMmax).

The write command enables or disables the presentation of unsolicited result codes to report the call charges.

Parameter Description

<n> ^{(num)(&W)(&V)}	
[0] ^(&F)	suppress unsolicited result code
1	display unsolicited result code
<acm> ^{(str)(&V)}	
Three bytes of the current ACM value in hexadecimal format (e.g. "00001E" indicates decimal value 30) 000000-FFFFFF	
<acmMax> ^{(str)(&V)}	
Three bytes of the max. ACM value in hexadecimal format (e.g. "00001E" indicates decimal value 30) 000000 disable ACMmax feature 000001-FFFFFF	

<CCM>^(str)

Three bytes of the current CCM value in hexadecimal format (e.g. "00001E" indicates decimal value 30); bytes are coded in the same way as ACMmax value in the SIM 000000-FFFFFF

Notes

- When you power down or reset the ME with [AT+CFUN=1,1](#) the URC presentation mode will be reset to its default. To benefit from the URC it is recommended to have the setting included in the user profile saved with [AT&W](#), or to select <n>=1 every time you reboot the ME.
- See also GSM07.07: [AT+CACM](#), [AT+CAMM](#), [AT+CAOC](#).

9.3 AT+CAMM Accumulated call meter maximum (ACMmax) set or query

Syntax

<p>Test Command</p> <p>AT+CAMM=?</p> <p>Response(s)</p> <p>OK</p>	
<p>Read Command</p> <p>AT+CAMM?</p> <p>Response(s)</p> <p>+CAMM: <acmmax></p> <p>OK</p> <p>ERROR</p> <p>+CME ERROR: <err></p>	
<p>Write Command</p> <p>AT+CAMM=[<acmmax>[, <passwd>]]</p> <p>Response(s)</p> <p>OK</p> <p>ERROR</p> <p>+CME ERROR: <err></p>	
<p>Reference(s)</p> <p>GSM 07.07</p>	

Command Description

The read command returns the current ACMmax value.

The write command sets the Advice of Charge related to the accumulated call meter maximum value in SIM file EF (ACMmax). ACMmax contains the maximum number of home units allowed to be consumed by the subscriber.

Parameter Description

<acmmax>^(str)

Three bytes of the max. ACM value in hexadecimal format (e.g. "00001E" indicates decimal value 30) 000000 disable ACMmax feature 000001-FFFFFF.

<passwd>^(str)

SIM PIN2

9.4 AT+CAOC Advice of Charge information

Syntax

<p>Test Command</p> <p>AT+CAOC=?</p> <p>Response(s)</p> <p>+CAOC: (list of supported<mode>s)</p> <p>OK</p>	
<p>Read Command</p> <p>AT+CAOC?</p> <p>Response(s)</p> <p>+CAOC: <mode></p> <p>OK</p>	
<p>Exec Command</p> <p>AT+CAOC</p> <p>Response(s)</p> <p>ERROR</p> <p>+CME ERROR: <err></p> <p>If <mode>=0, TA returns the current call meter value:</p> <p>+CAOC: <ccm></p> <p>OK</p>	
<p>Write Command</p> <p>AT+CAOC=[<mode>]</p> <p>Response(s)</p> <p>ERROR</p> <p>+CME ERROR: <err></p> <p>If <mode>=0, TA returns the current call meter value.</p> <p>OK</p>	
<p>Reference(s)</p> <p>GSM 07.07</p>	

Command Description

Execute command returns the current call meter value.
The write command sets the Advice of Charge supplementary service function mode.

Parameter Description

<mode> ^{(num)&(V)}	
0	query CCM value
<ccm> ^(str)	
Three bytes of the current CCM value in hexadecimal format (e.g. "00001E" indicates decimal value 30); bytes are similarly coded as ACMmax value in the SIM 000000-FFFFFF.	

9.5 AT+CCUG Closed User Group

Syntax

<p>Test Command</p> <pre>AT+CCUG=?</pre> <p>Response(s)</p> <pre>+CCUG: list of supported <n>, range of supported <index>, range of supported <info> OK ERROR +CME ERROR</pre>	
<p>Read Command</p> <pre>AT+CCUG?</pre> <p>Response(s)</p> <pre>+CCUG: <n>, <index>, <info> OK ERROR +CME ERROR</pre>	
<p>Write Command</p> <pre>AT+CCUG=[[<n>][, <index>][, <info>]]</pre> <p>Response(s)</p> <pre>OK ERROR +CME ERROR</pre>	
<p>Reference(s)</p> <pre>GSM 07.07, GSM 02.85, GSM 03.85, GSM 04.85</pre>	

Command Description

The Test command returns the supported parameters.

The Read command returns if the Explicit CUG invocation is activated (in parameter <n>), which CUG <index> is chosen, and if Preferential Group or Outgoing Access is suppressed (in parameter <info>).

The write command serves to activate or deactivate the explicit CUG invocation, to set the desired index, and to specify if Preferential Group or Outgoing Access shall be suppressed.

Parameter Description

<n>^(num)	
explicit CUG invocation options	
0 ^(D)	Deactivate explicit CUG invocation
1	Activate explicit CUG invocation
<index>^(num)	
0-9	explicit selection of CUG index
10 ^(D)	No index (preferred CUG taken from subscriber data)

<info>^(num)

state of the call

0 ^(D)	no information
1	suppress outgoing access
2	suppress preferential CUG
3	Suppress preferential CUG and Outgoing Access.

Notes

- The active settings for omitted parameters are retained without changes.
- Explicit CUG invocation means that at each call setup, CUG information is added to the called number.
- Upon delivery, settings are predefined with
<n>=0,
<index>=10,
<info>=0.
These delivery defaults cannot be recalled automatically.
- When starting a call with [ATD](#), Parameter 'G' or 'g' of command [ATD](#) will have no effect if the option selected for this single call is identical to the option already selected with [AT+CCUG](#).
- Current settings are saved in the ME automatically.
- [ATZ](#) or [AT&F](#) do not influence the current settings.
- some combinations of parameters may lead to rejection of CUG calls by the network. For more information, please consult GSM 04.85

9.6 AT+CCFC Call forwarding number and conditions control

AT+CCFC controls the call forwarding supplementary service. Registration, erasure, activation, deactivation and status query are supported.

Syntax

<p>Test Command</p> <pre>AT+CCFC=?</pre> <p>Response(s)</p> <pre>+CCFC: (list/range of supported <reason>s) OK</pre>	<p>Write Command</p> <pre>AT+CCFC=<reason>, <mode>[, <number>[, <type>[, <class>[, <time>]]]]</pre> <p>Response(s)</p> <pre>If <mode> is not equal 2 and command successful: OK If <mode>= 2, <reason> is not equal 2 and command successful: +CCFC: <status>, <class>[, <number>, <type>] OK If <mode>= 2, <reason>= 2 and command successful: +CCFC: <status>, <class>[, <number>, <type>, <time>] OK If error is related to ME functionality +CME ERROR</pre>
<p>Reference(s)</p> <pre>GSM 07.07, GSM 02.04, GSM 02.82, GSM 03.82, GSM 04.82</pre>	

Parameter Description

<reason> ^(num)	
Reason for call forwarding	
0	unconditional
1	mobile busy
2	no reply
3	not reachable
4	all call forwarding (includes reasons 0, 1, 2 and 3)
5	all conditional call forwarding (includes reasons 1, 2 and 3)
<mode> ^(num)	
Network operation to be performed for Supplementary service "call forwarding"	
0	disable call forwarding (disable service)
1	enable call forwarding (enable service)
2	query status of call forwarding (query service status)
3	register <number> and activate call forwarding (register service)
4	erase <number> and deactivate call forwarding (erase service)

<number>^(str)

String type phone number of forwarding address in format specified by <type>. If you select <mode>= 3, the phone <number> will be registered in the network. This allows you to disable / enable CF to the same destination without the need to enter the phone number once again. Depending on the services offered by the provider the registration may be mandatory before CF can be used. The number remains registered in the network until you register another number or erase it using <mode> = 4.

<type>^(num)

Type of address octect

145	dialing string <number> includes international access code character '+'
129	otherwise

<class>^(num)

Integer or sum of integers each representing a class of information, i.e. a bearer service, telecommunication service or bearer service group as defined in "GSM 02.04"

1	voice
2	data <class> 2 (data) comprises all those <class> values between 16 and 128, that are supported both by the network and the MS. This means, a setting made for <class> 2 applies to all remaining data classes (if supported). In addition, you can assign a different setting to a specific class. For example, you can activate Call Forwarding for all data classes, but deactivate it for a specific data class.
4	fax
8	SMS
16	data circuit sync
32	data circuit async
64	dedicated packet access
128	dedicated PAD access
1...[7]...255	combination of some of the above classes. For example, the default setting 7 represents the sum of the integers 1, 2 and 4 (CF for voice, data and fax). The value 255 covers all classes. If the <class> parameter is omitted, the default value 7 is used.

<time>^(num)

5...[20]...30	Time to wait before call is forwarded, rounded to a multiple of 5 sec. (only for <reason>=no reply)
---------------	---

<status>^(num)

0	Call Forwarding not active
1	Call Forwarding active

Notes

- You can register, disable, enable and erase <reason> 4 and 5 as described above. However, querying the status of <reason> 4 and 5 with AT+CCFC will result in an error ("CME error: Operation not supported"). As an alternative, you may use the ATD command followed by *# codes to check the status of these two reasons. See [Star-Hash \(*#\) Network Commands](#) for a complete list of *# GSM codes. See also examples below.
- Most networks will not permit registration of new parameters for conditional call forwarding (reasons 1,2,3,5) while unconditional call forwarding is enabled.
- The AT+CCFC command offers a broad range of call forwarding options according to the GSM specifications.

However, when you attempt to set a call forwarding option which is not provisioned or not yet subscribed to, the setting will not take effect regardless of the response returned. The responses in these cases vary with the network (for example "OK", "Operation not allowed", "Operation not supported" etc.). To make sure check the call forwarding status with `<mode>=2`.

- Some networks may choose to have certain call forwarding conditions permanently enabled (e.g. forwarding to a mailbox if the mobile is not reachable). In this case, erasure or deactivation of call forwarding for these conditions will not be successful, even if the CCFC request is answered with response "OK".
- The command has been implemented with the full set of `<class>` parameters according to GSM 07.07. For actual applicability of SS "call forwarding" to a specific service or service group (a specific `<class>` value) please consult table A.1 of GSM 02.04.
- There is currently no release of GSM standard "GSM 02.04", in which the "Call Forwarding" Supplementary Service is defined as applicable to SMS services.

Example

Please note that when you configure or query call forwarding without specifying any classes, the settings will refer to classes 1, 2 and 4 only (=default). The handling of classes is equivalent to [AT+CLCK](#).

- To register the destination number for unconditional call forwarding (CFU):

```
at+ccfc=0,3,"+493012345678",145
OK
```

The destination number will be registered for voice, data and fax services (default `<class>` 7). In most networks, the registration will also cause call forwarding to be activated for these `<class>` values.

- To query the status of CFU without specifying `<class>`:

```
at+ccfc=0,2
+CCFC: 1,1,"+493012345678",145
+CCFC: 1,2,"+493012345678",145
+CCFC: 1,4,"+493012345678",145
OK
```

- To deactivate CFU without specifying `<class>`:

```
at+ccfc=0,0
OK
```

To check whether CFU was successfully deactivated (note that the destination number remains registered in the network when you disable CFU):

```
at+ccfc=0,2
+CCFC: 0,1,"+493012345678",145
+CCFC: 0,2,"+493012345678",145
+CCFC: 0,4,"+493012345678",145
OK
```

- To erase the registered CFU destination number:

```
at+ccfc=0,4
OK
```

Now, when you check the status, no destination number will be indicated:

```
at+ccfc=0,2
+CCFC: 0,1
+CCFC: 0,2
+CCFC: 0,4
OK
```

- To query the status of CFU for all classes:

```
at+ccfc=0,2,,,255
+CCFC: 0,1
+CCFC: 0,2
+CCFC: 0,4
+CCFC: 0,8
+CCFC: 0,16
+CCFC: 0,32
+CCFC: 0,64
+CCFC: 0,128
OK
```

- [<reason>](#) 4 or 5 cannot be used to query the status of all call forwarding reasons (see also notes above):

```
at+ccfc=4,2
+CME error: operation not supported
at+ccfc=5,2
+CME error: operation not supported
```

9.7 AT+CCWA Call Waiting

The **AT+CCWA** write command controls the "Call Waiting" supplementary service according to GSM 02.83. Activation, deactivation and status query are supported. The read command returns the current value of **<n>**.

Syntax

<p>Test Command</p> <p>AT+CCWA=?</p> <p>Response(s)</p> <p>+CCWA: (list of supported <n>s)</p> <p>OK</p>																					
<p>Read Command</p> <p>AT+CCWA?</p> <p>Response(s)</p> <p>+CCWA: <n></p> <p>OK</p>																					
<p>Write Command</p> <p>AT+CCWA=[[<n>][, <mode>][, <class>]]</p> <p>Response(s)</p> <p>If <mode> is not equal 2 and command successful:</p> <p>OK</p> <p>If <mode>= 2 and command successful:</p> <p>+CCWA: <status>, <class></p> <p>[+CCWA: <status>, <class>]</p> <p>[+CCWA: ...]</p> <p>OK</p> <p>If error is related to ME functionality</p> <p>+CME ERROR</p>																					
<p>Reference(s)</p> <p>GSM 07.07, GSM 02.04, GSM 02.83, GSM 03.83, GSM 04.83</p>	<table border="1"> <tr> <td>PIN</td> <td>ASC0</td> <td>ASC1</td> <td>USB</td> <td>MUX1</td> <td>MUX2</td> <td>MUX3</td> <td>Charge</td> <td>→</td> <td>Last</td> </tr> <tr> <td>●</td> <td>●</td> <td>●</td> <td>●</td> <td>●</td> <td>●</td> <td>●</td> <td>○</td> <td>○</td> <td>○</td> </tr> </table>	PIN	ASC0	ASC1	USB	MUX1	MUX2	MUX3	Charge	→	Last	●	●	●	●	●	●	●	○	○	○
PIN	ASC0	ASC1	USB	MUX1	MUX2	MUX3	Charge	→	Last												
●	●	●	●	●	●	●	○	○	○												

Unsolicited Result Codes

URC 1

Indication of a call that is currently waiting and can be accepted.

+CCWA: <calling number>, <type of number>, <class>, , <CLI validity>

If <n>=1 and the call waiting supplementary service is enabled in the network, URC "+CCWA" indicates a waiting call to the TE. It appears while the waiting call is still ringing.

URC 2

Indication of a call that has been waiting.

^SCWA

If <n>=1 and the call waiting supplementary service is enabled in the network, this URC indicates that a waiting call rang when the ME was in online mode during a CSD call, but the calling party hung up before the ME went back to command mode.

Parameter Description

`<n>`^(num)

Switch URCs "+CCWA" and "^SCWA" for call waiting on/off

0	Disable display of URCs "+CCWA" and "^SCWA"
1	Enable display of URCs "+CCWA" and "^SCWA"

`<mode>`^(num)

Network operation to be performed for Supplementary service call waiting

0	Disable call waiting (disable service)
1	Enable call waiting (enable service)
2	Query status of call waiting (query service status)

`<class>`^(num)

Integer or sum of integers each representing a class of information, i.e. a bearer service, telecommunication service or bearer service group as defined in "GSM 02.04".

In the write command, parameter `<class>` specifies the class of the active call during which an incoming call of any class is to be regarded as a waiting call.

In URC "+CCWA: `<calling number>`, `<type of number>`, `<class>`, , `<CLI validity>`", parameter `<class>` specifies the class of the waiting call.

1	Voice
2	Data <class> 2 (data) comprises all those <class> values between 16 and 128, that are supported both by the network and the MS. This means, a setting made for <class> 2 applies to all remaining data classes (if supported). In addition, you can assign a different setting to a specific class. For example, you can activate call waiting for all data classes, but deactivate it for a specific data class.
4	Fax
[7]	Voice, data and fax (1+2+4)
8	SMS
16	Data circuit sync
32	Data circuit async
64	Dedicated packet access
128	Dedicated PAD access
1...[7]...255	Combination of some of the above classes. For example, the default setting 7 represents the sum of the integers 1, 2 and 4 (CF for voice, data and fax). The value 255 covers all classes. If parameter "class" is omitted, the default value 7 is used.

`<status>`^(num)

0	Call waiting service is not active
1	Call waiting service is active

`<calling number>`^(str)

Phone number of waiting caller in the format specified by parameter `<type of number>`.

<type of number>^(num)

Type of address octet in integer format (refer to GSM 04.08, subclause 10.5.4.7)

145	<calling number> includes international access code character '+'
129	Otherwise

<CLI validity>^(num)

0	CLI valid
1	CLI has been withheld
2	CLI is not available

Notes

- If the active call is a CSD call, and a waiting call is received, then the ME produces a BREAK while still in online mode, and displays
 - the +CCWA URC (as above) when the ME goes back to command mode while the waiting call is still active and can be accepted;
 - or the ^SCWA URC (as above) when the ME goes back to command mode after the waiting call has ended.
- With the AT+CHLD command, it is possible to establish a multiparty call or to set the active voice call on hold and then accept a waiting voice call (not possible with fax and data call). See also [AT+CHLD](#)
- Users should be aware that if call waiting is activated (<mode>=1), the presentation of URCs needs to be enabled, too (<n>=1).
Otherwise, on the one hand, a waiting caller would be kept waiting due to lack of BUSY signals, while, on the other hand, the waiting call would not be indicated to the called party.
- The AT+CCWA command offers a broad range of options according to the GSM specifications. However, when you attempt to enable call waiting for a <class> for which the service is not provisioned or not supported, the setting will not take effect regardless of the response returned. The responses in these cases vary with the network (for example "OK", "Operation not allowed", "Operation not supported" etc.). To make sure check the current call waiting settings with <mode>=2.
- The AT+CCWA command has been implemented with the full set of <class> parameters according to GSM 07.07. For actual applicability of SS call waiting to a specific service or service group (a specific <class> value) please consult table A.1 of GSM 02.04
- Despite the specifications stated in GSM 02.04 call waiting is not handled uniformly among all networks: GSM 02.04, Annex A, provides the following specification:
"The applicability of call waiting refers to the telecommunication service of the active call and not of the waiting call. The incoming, waiting, call may be of any kind." Nevertheless, networks do differ on the actual implementation of the service. For example, the activation of call waiting for <class> 4, "fax", causes some networks to send a call waiting indication if a call "of any kind" comes in during an active fax call, but others may (with the same settings active) indicate a waiting fax call during any kind of active call. Thus, the only reliable way to receive or prevent a call waiting indication under any circumstances and in any network, is to activate or deactivate call waiting for all tele- and bearer services (<class> 255).

Examples

EXAMPLE 1

Parameter **<n>**

```
at+ccwa=1          To enable the presentation of the URC
OK
```

EXAMPLE 2

Parameter **<mode>**

```
at+ccwa=, 1        To activate the supplementary service in the network for voice, data, and
                    fax calls (default classes).
                    Note that parameter <n> is left out. In this case, the current value of <n>
                    will be retained.

OK
at+ccwa=, 2        To query the network status of call waiting for default classes
at+ccwa=1, 1       Call Waiting is activated during voice calls.
at+ccwa=1, 2       Call Waiting is activated during data calls.
at+ccwa=1, 4       Call Waiting is activated during fax calls.
OK
```

EXAMPLE 3

Parameter **<class>**

```
AT+CCWA=, 0, 1     To deactivate call waiting for voice calls.
OK
```

9.8 AT+CHLD Call Hold and Multiparty

Syntax

<p>Test Command</p> <pre>AT+CHLD=?</pre> <p>Response(s)</p> <pre>+CHLD: (list of supported <n>s) OK</pre>	
<p>Write Command</p> <pre>AT+CHLD=<n></pre> <p>Response(s)</p> <pre>OK ERROR +CME ERROR: <err></pre>	
<p>Reference(s)</p> <pre>GSM 07.07</pre>	

Command Description

TA controls the Supplementary Services Call Hold and Multiparty. Calls can be put on hold, recovered, released, and added to a conversation.

Like for all Supplementary Services, the availability and detailed functionality of Call Hold and Multiparty services depends on the configuration of the GSM network. The TC65 can only request the service, but the network decides whether and how the request will be answered.

Parameter Description

<n> ^(num)	
0	<p>Release all held calls or set User Determined User Busy (UDUB) for a waiting call:</p> <ul style="list-style-type: none"> If a call is waiting, release the waiting call. The calling party will receive a "BUSY" indication (Supplementary Service User Determined User Busy "UDUB") Otherwise, terminate all held calls (if any).
1	<p>Terminate all active calls (if any) and accept "the other call" as the active call:</p> <ul style="list-style-type: none"> If a call is waiting, the waiting call will be accepted. Otherwise, if a held call is present, the held call becomes active.
1X	<p>Terminate a specific call X (X= 1-7). The call may be active, held or waiting. The remote party of the terminated call will receive a "NO CARRIER" indication. Parameter X is the call number <idx> of the targeted call in the list of current calls available with AT command AT+CLCC.</p>
2	<p>Place all active calls on hold (if any) and accept "the other call" as the active call:</p> <ul style="list-style-type: none"> If a call is waiting, the waiting call will be accepted. Otherwise, if a held call is present, the held call becomes active.
2X	<p>Place all active calls except call X (X= 1-7) on hold. Parameter X is the call number <idx> of the targeted call in the list of current calls available with AT command AT+CLCC.</p>
3	<p>Add a held call to the active calls in order to set up a conference (multiparty) call.</p>

Notes

- The **AT+CHLD** command offers a broad range of options according to the GSM specifications. However, if you attempt to invoke an option which is not provisioned by the network, or not subscribed to, invocation of this option will fail. The responses in these cases may vary with the network (for example "Operation not allowed", "Operation not supported" etc.).
- The handling of the supplementary service Call hold and Multiparty varies with the types of calls. This is because only voice calls can be put on hold, while data or fax calls cannot. The following procedures apply: With **AT+CHLD=2** the user can simultaneously place a voice call on hold and accept another waiting voice, data or fax call. If the waiting call is a data or fax call, it is also possible to put the voice call on hold. To switch back from the active data or fax call to the held voice call the active call must be terminated with **AT+CHLD=1**. If all active and held calls are voice calls it is possible to switch back and forth with **AT+CHLD=2**.
- In conflict situations, e.g. when a waiting call comes while there are already held calls, the above procedures apply to the waiting call only. For example, **<n>=0** rejects the waiting call, but does not affect the held calls.
- See also the **AT+CCWA** command for details on how to display waiting calls.

Example

<pre> ^SYSSTART at+cpin="9999" OK +CREG: 2 +CREG: 1,"0145","0016" at+ccwa=1,1,1 OK atd"1234567"; OK +CCWA: "+491791292364",145,32,,0 at+chld=2 CONNECT 9600/RLP hello +++ OK at+clcc +CLCC: 1,0,1,0,0,"03038639268",129 +CLCC: 2,1,0,1,0,"+491791292364",145 OK at+chld=1 OK at+clcc +CLCC: 1,0,0,0,0,"03038639268",129 OK </pre>	<p>The mobile is now registered. You activate the indication of waiting calls during voice calls.</p> <p>You make a voice call.</p> <p>You receive a URC indicating a waiting data call. You put the voice call on hold. The data connection is set up.</p> <p>With "+++" you go in command mode.</p> <p>You interrogate the status of all established calls.</p> <p>The active data call is terminated and the held voice call becomes active.</p>
---	---

9.9 AT+CLIP Calling line identification presentation

This command refers to the GSM supplementary service CLIP (Calling Line Identification Presentation) that enables a called subscriber to get the calling line identity (CLI) of the calling party when receiving a mobile terminated call.

Syntax

<p>Test Command</p> <p>AT+CLIP=?</p> <p>Response(s)</p> <p>+CLIP: (list of supported<n>s)</p> <p>OK</p>	
<p>Read Command</p> <p>AT+CLIP?</p> <p>Response(s)</p> <p>+CLIP: <n>, <m></p> <p>OK</p> <p>ERROR</p> <p>+CME ERROR: <err></p>	
<p>Write Command</p> <p>AT+CLIP=<n></p> <p>Response(s)</p> <p>OK</p> <p>ERROR</p> <p>+CME ERROR: <err></p>	
<p>Reference(s)</p> <p>GSM 07.07, GSM 02.81</p>	<p>PIN ASC0 ASC1 USB MUX1 MUX2 MUX3 Charge → Last</p> <p><input type="radio"/> <input checked="" type="radio"/> <input checked="" type="radio"/> <input checked="" type="radio"/> <input checked="" type="radio"/> <input checked="" type="radio"/> <input checked="" type="radio"/> <input type="radio"/> <input type="radio"/> <input type="radio"/></p>

Unsolicited Result Codes

URC 1

Voice call response format:

+CLIP: <number>, <type>, , [, <alpha>] [, <CLI validity>]

URC 2

Data/FAX call response format:

+CLIP: <number>, <type>

When CLIP is enabled at the TE (and is permitted by the calling subscriber), an unsolicited result code is returned after every RING (or +CRING: <type>) at a mobile terminating call.

Command Description

Test command returns values supported by the TA as a compound value.

Read command gives the status of <n>, and also triggers an interrogation of the provision status of the CLIP service according GSM 02.81 (given in <m>).

If no SIM card is available or SIM-Pin isn't entered, the command response is "ERROR".

Write command enables or disables the presentation of the CLI at the TE. It has no effect on the execution of the supplementary service CLIP in the network.

Parameter Description

<n>^{(num)(&W)(&V)}

[0] ^(&F)	suppress unsolicited result codes
1	display unsolicited result codes

<m>^{(num)(&V)}

0	CLIP not provisioned
1	CLIP provisioned
2	unknown

<number>^(str)

string type phone number of calling address in format specified by <type>

<type>^(num)

type of address octet in integer format; 145 when dialling string includes in-ternational access code character "+", otherwise 129.

<alpha>^(str)

string type alphanumeric representation of <number> corresponding to the entry found in phonebook; used character set should be the one selected with command Select TE Character Set [AT+CSCS](#)

<CLI validity>^(num)

0	CLI valid
1	CLI has been withheld by the originator.
2	CLI is not available due to interworking problems or limitations of originating network. <number> shall be an empty string ("") and <type> value will not be significant.

When CLI is not available (<CLI validity>=2), <number> shall be an empty string ("") and <type> value will not be significant. Nevertheless, TA shall return the recommended value 128 for <type> (TON/NPI unknown in accordance with GSM 04.08 subclause 10.5.4.7).

When CLI has been withheld by the originator, (<CLI validity>=1) and the CLIP is provisioned with the "override category" option (refer GSM 02.81 and GSM 03.81), <number> and <type> is provided. Otherwise, TA shall return the same setting for <number> and <type> as if the CLI was not available.

9.10 AT+CLIR Calling line identification restriction

The [AT+CLIR](#) command refers to the GSM supplementary service CLIR (Calling Line Identification Restriction).

Syntax

<p>Test Command</p> <p>AT+CLIR=?</p> <p>Response(s)</p> <p>+CLIR: (list of supported <n>s)</p> <p>OK</p>	
<p>Read Command</p> <p>AT+CLIR?</p> <p>Response(s)</p> <p>+CLIR<n>, <m></p> <p>OK</p> <p>ERROR</p> <p>+CME ERROR: <err></p>	
<p>Write Command</p> <p>AT+CLIR=[<n>]</p> <p>Response(s)</p> <p>OK</p> <p>ERROR</p> <p>+CME ERROR: <err></p>	
<p>Reference(s)</p> <p>GSM 07.07</p>	<p>PIN ASC0 ASC1 USB MUX1 MUX2 MUX3 Charge → Last</p> <p>● ● ● ● ● ● ○ ○ ○</p>

Parameter Description

<n> ^(num)	
Parameter shows the settings for outgoing calls:	
[0] ^(P)	Presentation indicator is used according to the subscription of the CLIR service
1	CLIR invocation
2	CLIR suppression
<m> ^(num)	
Parameter shows the subscriber CLIR service status in the network:	
0	CLIR not provisioned
1	CLIR provisioned in permanent mode
2	Unknown (e.g. no network, etc.)
3	CLIR temporary mode presentation restricted
4	CLIR temporary mode presentation allowed

Note

- The settings made with [AT+CLIR=1](#) or [AT+CLIR=2](#) are used for all outgoing calls until the ME is switched off or [AT+CLIR=0](#) is used.

9.11 AT+COLP Connected Line Identification Presentation

This command refers to the GSM supplementary service COLP (Connected Line Identification Presentation) that enables a calling subscriber to get the connected line identity (COL) of the called party after setting up a mobile originated call. The command enables or disables the presentation of the COL at the TE. It has no effect on the execution of the supplementary service COLR in the network.

Syntax

<p>Test Command</p> <p>AT+COLP=?</p> <p>Response(s)</p> <p>+COLP : (list of supported <n>s)</p> <p>OK</p>	
<p>Read Command</p> <p>AT+COLP?</p> <p>Response(s)</p> <p>+COLP: <n>, <m></p> <p>OK</p> <p>ERROR</p> <p>+CME ERROR: <err></p>	
<p>Write Command</p> <p>AT+COLP=[<n>]</p> <p>Response(s)</p> <p>OK</p> <p>ERROR</p> <p>+CME ERROR: <err></p>	
<p>Reference(s)</p> <p>GSM 07.07</p>	<p>PIN ASC0 ASC1 USB MUX1 MUX2 MUX3 Charge → Last</p> <p>● ● ● ● ● ● ● ○ ○ ○</p>

Unsolicited Result Code

Call response format:

+COLP: <number>, <type>

Parameter Description

<n>^(num)	
0	Disable - suppress unsolicited result codes
1	Enable - display unsolicited result codes
<m>^(num)	
0	COLP not provisioned (no presentation)
1	COLP provisioned
2	Unknown
<number>^(str)	
String type phone number of connected address in format specified by <type>	

<type>^(num)

Type of address octet in integer format; 145 when dialling string includes international access code character "+", otherwise 129.

9.12 AT+CPUC Price per unit and currency table

Syntax

<p>Test Command</p> <pre>AT+CPUC=?</pre> <p>Response(s)</p> <pre>OK</pre>	
<p>Read Command</p> <pre>AT+CPUC?</pre> <p>Response(s)</p> <pre>+CPUC: <currency>, <ppu> OK ERROR +CME ERROR: <err></pre>	
<p>Write Command</p> <pre>AT+CPUC=<currency>, <ppu>[, <passwd>]</pre> <p>Response(s)</p> <pre>OK ERROR +CME ERROR: <err></pre>	
<p>Reference(s)</p> <pre>GSM 07.07</pre>	

Command Description

Read command returns the current parameters of PUC.

Write command sets the parameters of Advice of Charge related price per unit and currency table. SIM PIN2 is usually required to set the parameters.

Parameter Description

`<currency>`^{(str)(+CSCS)}

Three-character currency code (e.g. "GBP", "EUR"). If the currency name is longer than three characters, all characters will be cut off after the third position. Before they are written to the SIM Card, these characters are converted to the standard GSM alphabet.

`<ppu>`^(str)

Price per unit; dot is used as a decimal separator (e.g. "2.66"). The length is limited to 20 characters. If the string length is exceeded, the command is terminated with an error. This string may only contain digits and a dot. Leading zeros are removed from the string. The minimum and maximum value are determined by the structure of the SIM-PUCT file. The maximum price per unit value is 999 999 999.00. When successfully entered, this value is rounded to maximum accuracy.

Note: Due to storage in mantisse (range 0-4095) and exponent (-7 to 7) it is possible that rounding errors occur.

`<passwd>`^(str)

SIM PIN2. String parameter which can contain any combination of characters. The maximum string length is limited to 8 characters. If this value is exceeded, the command terminates with an error message. If the PIN2 is incorrect, a CME error (+CME ERROR: incorrect password) is output.

Example

To change currency and/or price per unit you have two ways:

You can enter PIN2 along with the [AT+CPUC](#) command:

```
AT+CPUC="EUR", "0.10", "8888" (where "8888" = PIN2)
OK
```

Alternatively, you can first use the [AT+CPIN2](#) command to enter PIN2. When you execute the [AT+CPUC](#) command, subsequently, take into account that PIN2 authentication expires after 300ms (see notes in [AT+CPIN2](#)).

```
AT+CPUC="EUR", "0.10"
OK Successful
AT+CPUC="EUR", "0.10"
+CME ERROR: SIM PIN2 required Attempt not successful. PIN2 authentication has expired.
```

9.13 AT+CSSN Supplementary service notifications

Syntax

<p>Test Command</p> <p>AT+CSSN=?</p> <p>Response(s)</p> <p>+CSSN: (list of supported<n>s), (list of supported<m>s)</p> <p>OK</p>	
<p>Read Command</p> <p>AT+CSSN?</p> <p>Response(s)</p> <p>+CSSN: <n>, <m></p> <p>OK</p>	
<p>Write Command</p> <p>AT+CSSN=<n>[, <m>]</p> <p>Response(s)</p> <p>OK</p> <p>ERROR</p> <p>+CME ERROR</p>	
<p>Reference(s)</p> <p>GSM 07.07</p>	<p>PIN ASC0 ASC1 USB MUX1 MUX2 MUX3 Charge → Last</p> <p><input type="radio"/> <input checked="" type="radio"/> <input checked="" type="radio"/> <input checked="" type="radio"/> <input checked="" type="radio"/> <input checked="" type="radio"/> <input checked="" type="radio"/> <input checked="" type="radio"/> <input type="radio"/> <input type="radio"/> <input type="radio"/></p>

Unsolicited Result Codes

URC 1

+CSSI: <code 1>

When <n>=1 and a supplementary service notification is received after a mobile originated call setup, intermediate result code "+CSSI: <code 1>" is sent to TE before any other MO call setup result codes

URC 2

+CSSU: <code 2>

When <m>=1 and a supplementary service notification is received during a mobile terminated call setup or during a call, unsolicited result code "+CSSU: <code 2>" is sent to TE.

Command Description

The write command enables or disables the presentation of URCs for supplementary services.

Parameter Description

<n>^(num)	
0(&F)	Suppress "+CSSI" URCs
1	Activate "+CSSI" URCs
<m>^(num)	
0(&F)	Suppress "+CSSU" URCs
1	Activate "+CSSU" URCs

<code 1>^(num)

0	unconditional call forwarding is active
1	some of the conditional call forwardings are active
2	call has been forwarded
3	Waiting call is pending

<code 2>^(num)

0	The incoming call is a forwarded call.
5	Held call was terminated
10	unconditional call forwarding is active

Note

- URCs will be displayed only if the call concerned is a voice call, but some URCs will be displayed as well as for data calls (like "+CSSU"=0).

9.14 AT+CUSD Supplementary service notifications

This command allows control of the Unstructured Supplementary Service Data (USSD) according to GSM 02.90. Both network and mobile initiated operations are supported.

Syntax

<p>Test Command</p> <p>AT+CUSD=?</p> <p>Response(s)</p> <p>+CUSD: (list of supported<n>s)</p> <p>OK</p>	
<p>Read Command</p> <p>AT+CUSD?</p> <p>Response(s)</p> <p>+CUSD: <n></p> <p>OK</p>	
<p>Write Command</p> <p>AT+CUSD=<n>[, <str>[, <dcs>]]</p> <p>Response(s)</p> <p>OK</p> <p>+CME ERROR</p>	
<p>Reference(s)</p> <p>GSM 07.07, GSM 02.90, GSM 03.90, GSM 04.90</p>	<p>The status bar contains the following indicators: PIN (filled circle), ASC0 (filled circle), ASC1 (filled circle), USB (filled circle), MUX1 (filled circle), MUX2 (filled circle), MUX3 (filled circle), Charge (empty circle), and Last (empty circle).</p>

Unsolicited Result Code

+CUSD: <m> [<str> [<dcs>]]

URC "+CUSD" indicates an USSD response from the network, or network initiated operation

Command Description

The read command returns the current <n> value

Write command parameter <n> is used to disable/enable the presentation of an unsolicited result code (USSD response from the network, or network initiated operation) "+CUSD: <m> [<str> [<dcs>]]" to the TE.

When <str> is given, a mobile initiated USSD string or a response USSD string to a network initiated operation is sent to the network. The response USSD string from the network is returned in a subsequent unsolicited result code "+CUSD"

The interaction of this command with other commands based on other GSM supplementary services is described in the GSM standard.

Parameter Description

<n> ^(num)	
0(&F)	Disable the result code presentation in the TA
1	Enable the result code presentation in the TA
2	Cancel session (not applicable to read command response)

`<str>`^(str)

String type USSD-string (when `<str>` parameter is not given, network is not interrogated).

If `<dcS>` indicates that GSM 03.38 default alphabet is used TA converts GSM alphabet into current TE character set according to rules of GSM 07.05 Annex A.

`<dcS>`^(num)

GSM 03.38 Cell Broadcast Data Coding Scheme in integer format (default 15)

`<m>`^(num)

0	No further user action required (network initiated USSD-Notify, or no further information needed after mobile initiated operation)
1	Further user action required (network initiated USSD-Request, or further information needed after mobile initiated operation). If <code><m>=1</code> , then the URC ends with ">" to prompt the user for input. The user action is finished with <code><CTRL-Z></code> or aborted with <code><ESC></code> .
2	USSD terminated by network.

Notes

- For the write command, only `<dcS>= 15` is supported.
- When a USSD string is sent via `ATD`, a "`AT+CUSS=1`" is executed implicitly.
- It is recommended to finalize or escape a pending USSD user interaction before further actions are done to prevent blocking situations.

10. Internet Service Commands

TC65 has an embedded TCP/IP stack that is driven by AT commands and enables the host application to easily access the Internet. The advantage of this solution is that it eliminates the need for the application manufacturer to implement own TCP/IP and PPP stacks, thus minimizing cost and time to integrate Internet connectivity into a new or existing host application. This chapter is a reference guide to all the AT commands and responses defined for use with the TCP/IP stack.

Access is provided to the following Internet Services:

1. Socket Client and Server for TCP, Client for UDP
2. FTP Client
3. HTTP Client
4. SMTP Client
5. POP3 Client

Step-by-step instructions on how to configure and use TCP/IP communications with TC65:

- First of all, create a connection profile with `AT^SICS`. The connection profile is a set of basic parameters which determines the type of connection to use for an Internet service. Up to 6 connection profiles can be defined, each identified by the `<conProfileId>`.
- Secondly, use `AT^SISS` to create a service profile based on one of the connection profiles. Up to 10 service profiles can be defined, each identified by the `<srvProfileId>`. The service profile specifies the type of Internet service to use, i.e. Socket, FTP, HTTP, or one of the email services SMTP or POP3. To assign a connection profile to a service profile, the `<conProfileId>` of `AT^SICS` must be entered as "conId" value of the `AT^SISS` parameter `<srvParmTag>`.
This offers great flexibility to combine connection profiles and service profiles. For example, you may have one connection profile (CSD or GPRS) specified with `AT^SICS` which can be associated with an SMTP service profile for sending emails and a POP3 service profile for retrieving emails.
- Once the connection profile and the service profile are created, an Internet session can be opened by entering the `AT^SISO` write command and the desired `<srvProfileId>`. Wait for the resulting URC.
- The next command determines the action to be performed, for example reading data with `AT^SISR` or writing data with `AT^SISW`. Wait for the resulting URC.
- Finally, to end a session, enter the `AT^SISC` write command and the `<srvProfileId>`.

General instructions for use of Internet Service AT commands:

- All settings of the Internet Service AT commands, including the profile parameters set with `AT^SICS` and `AT^SISS`, are volatile. Therefore, the best practice is to use scripts and let the host application handle the required AT commands.

Using Internet Service AT commands on several interfaces (ASC0, ASC1, USB or Multiplex mode on ASC0):

- A connection profile can be created on one interface and then viewed or changed on all other interfaces.
- A service profile can be used only on one interface at a time:
 - Changes to a service profile are allowed only on the same interface where it was created, trying to change it on another interface is denied with "+CME ERROR: Invalid index". If queried with the read command `AT^SISS` the entire profile is returned on the interface where the service profile was created, while on all other interfaces only the server type of the profile is stated.
 - If a service profile is active (after opening it with `AT^SISO`) on one interface, any attempt to open or close the same service profile on another interface is denied with "+CME ERROR: Operation temporary not allowed".
 - To free a service profile for use on another interface, use the `AT^SISS` command and select service type = "none". This action deletes the entire profile and restores all parameters of the profile to their initial power-up state (all values are empty). For example, to remove the service profile 3, set `AT^SISS=3,svr-type,none`. After this, a new profile 3 can be created on any other interface.

Maximum number of profiles defined / used:

- Up to 6 connection profiles can be created (with AT^SICS).
- Up to 10 service profiles can be created (with AT^SISS), but the number of parallel profiles of the same service type is limited as listed below. If the maximum number of a service profile type is already defined, any attempt to set up another profile for the same type will be denied with "+CME ERROR: unknown".
 - Maximum 3 HTTP profiles
 - Maximum 6 socket profiles
 - 1 FTP profile
 - 1 POP3 profile
 - 1 SMTP profile
- The TCP/IP stack of TC65 supports using several service profiles at the same time, provided all of them are running on the same connection profile. For example, it is possible to download files from an FTP server, while sending and receiving emails at the same time.
- GPRS connections established over the Dial-Up Network do not use the embedded TCP/IP stack of TC65 and can be active at the same time. This allows the user to have two parallel GPRS connections: for example for sending or receiving emails over a GPRS connection enabled by the TCP/IP stack while, at the same time, surfing the Internet over a Dial-Up Network GPRS connection.

10.1 AT^SICS Internet Connection Setup Profile

AT^SICS serves to create and edit Internet connection profiles. A connection profile can be assigned to one or more service profiles defined with AT^SISS, and thus, determines which type of connection is to be established when opening a service profile with AT^SISO.

The AT^SICS read command requests the current settings of all Internet connection profiles. One line is issued for every possible parameter of a given <conParmTag> "conType" value.

The AT^SICS write command specifies all parameters of a connection profile identified by <conProfileId>. At first the type of Internet connection needs to be selected via <conParmTag> value "conType". This determines the applicability of all other <conParmTag> values related to this "conType" and automatically sets their defaults. To change the settings the write command needs to be executed for each single <conParmTag>.

Table 10.1: Applicability of AT^SICS <conParmTag> values

<conParmTag> value	CSD	GPRS0 / GPRS1
"conType"	mandatory	mandatory
"user"	optional	optional
"passwd"	optional	optional
"apn"	∅	mandatory
"inactTO"	optional	optional
"calledNum"	mandatory	∅
"dataRate"	mandatory	∅
"dataType"	mandatory	∅
"authMode"	mandatory	mandatory
"dns1"	optional	optional
"dns2"	optional	optional
"alphabet"	optional	optional

Syntax

<p>Test Command</p> <pre>AT^SICS=?</pre> <p>Response(s)</p> <pre>OK</pre>
<p>Read Command</p> <pre>AT^SICS?</pre> <p>Response(s)</p> <pre>^SICS: <conProfileId>, <conParmTag>, <conParmValue></pre> <pre>OK</pre>
<p>Write Command</p> <pre>AT^SICS=<conProfileId>, <conParmTag>, <conParmValue></pre> <p>Response(s)</p> <pre>OK</pre> <pre>ERROR</pre> <pre>+CME ERROR: <err></pre>

Parameter Description

`<conProfileId>`^(num)

Internet connection profile identifier.

The `<conProfileId>` identifies all parameters of a connection profile, and, when a service profile is created with `AT^SISS` the `<conProfileId>` needs to be set as "conId" value of the `AT^SISS` parameter `<srvParmTag>`.

0...5

`<conParmTag>`^(str)

Internet connection parameter.

“conType“	Type of Internet connection. For supported values of <code><conParmValue></code> refer to <code><conParmValue-conType></code> .
“alphabet“	Selects the character set for input and output of string parameters within a profile. The selected value is bound to the specific profile. This means that different profiles may use different alphabets. For supported values of <code><conParmValue></code> refer to <code><conParmValue-alphabet></code> .
“user“	User name string: maximum 32 characters (where "" is default).
“passwd“	Password string: maximum 32 characters (where "" is default).
“apn“	Access point name string value: maximum 100 characters (where "" is default).
“inactTO“	Inactivity timeout value in seconds: 0...65535 (where 0 is default).
“calledNum“	Called BCD number.
“dataRate“	Data rate. For supported values of <code><conParmValue></code> refer to <code><conParmValue-dataRate></code> .

“dataType“	Data call type. For supported values of <code><conParmValue></code> refer to <code><conParmValue-dataType></code> .
“authMode“	Authentication mode. For supported values of <code><conParmValue></code> refer to <code><conParmValue-auth-Mode></code> .
“dns1“	Primary DNS server address (IP address in dotted-four-byte format).
“dns2“	Secondary DNS server address (IP address in dotted-four-byte format).

`<conParmValue>`^(str)

Parameter value; type and supported content depend on related `<conParmTag>`.

`<conParmValue-conType>`^(str)

Supported connection type values in `<conParmValue>` for `<conParmTag>` value "conType".

“CSD“	Circuit-switched data call.
“GPRS0“	First GPRS connection. Settings of GPRS related commands are not used, e.g. AT+CGDCONT .
“GPRS1“	Second GPRS connection. Settings of GPRS related commands are not used, e.g. AT+CGDCONT .

`<conParmValue-alphabet>`^(str)

Character set selectable with `<conParmValue>` for `<conParmTag>` value "alphabet".

[“0“]	Character set determined with AT+CSCS applies.
“1“	International Reference Alphabet (IRA, seven bit ASCII) applies.

`<conParmValue-dataRate>`^(str)

Supported data rate values in `<conParmValue>` for `<conParmTag>` value "dataRate".

“0“	14.4 KBaud
[“1“]	9.6 KBaud

`<conParmValue-dataType>`^(str)

Supported data type values in `<conParmValue>` for `<conParmTag>` value "dataType".

“0“	ISDN
[“1“]	Analog

`<conParmValue-authMode>`^(str)

Supported authentication mode values in `<conParmValue>` for `<conParmTag>` value "authMode".

“none“	
[“PAP“]	
“CHAP“	
“MsChapV1“	

10.1.1 Example: Default values of a CSD connection profile

As stated earlier, the "conType" selected with `AT^SICS` determines all other matching profile parameters related to this "conType". Once "conType" is set in a new profile, the default values of all other related parameters are assumed. To view the default settings you can use the read command `AT^SICS?`.

<pre>at^sics=1,conType,CSD OK at^sics? ^SICS: 0, "conType", "" ^SICS: 1, "conType", "CSD" ^SICS: 1, "alphabet", "0" ^SICS: 1, "user", "" ^SICS: 1, "passwd", "" ^SICS: 1, "authMode", "PAP" ^SICS: 1, "inactTO", "0" ^SICS: 1, "calledNum", "" ^SICS: 1, "dataRate", "1" ^SICS: 1, "dataType", "1" ^SICS: 2, "conType", "" ^SICS: 3, "conType", "" ^SICS: 4, "conType", "" ^SICS: 5, "conType", "" OK</pre>	<p>Select connection type CSD, identified by <code><conProfileId>1</code></p> <p>Query current profiles. Profile with <code><conProfileId> 0</code> is still empty. The new CSD profile just created is indicated with all related parameters set to their default. Character set determined with <code>AT+CSCS</code> applies when string parameters are input with <code>AT^SICS</code>. No user name set. No password set. Authentication protocol PAP is assumed as default. No inactivity timeout set. No destination set. Data rate set to 9.6 kbaud. Remote device is analog, e.g. an analog modem. Profile with <code><conProfileId> 2</code> is still empty. Profile with <code><conProfileId> 3</code> is still empty. Profile with <code><conProfileId> 4</code> is still empty. Profile with <code><conProfileId> 5</code> is still empty.</p>
---	--

10.1.2 Example: GPRS connection profile

<pre>at^sics=0,conType,GPRS0 OK AT^SICS=0,inactTO,"0" OK AT^SICS=0,dns1,"193.254.160.1" OK AT^SICS=0,authMode,"PAP" OK AT^SICS=0,passwd,t-d1 OK AT^SICS=0,apn,"internet.t-d1.de" OK</pre>	<p>Select connection type GPRS0.</p> <p>Inactivity timeout = 0 (default).</p> <p>IP address of Primary DNS server.</p> <p>Authentication protocol PAP (default).</p> <p>Password for GPRS services provided by the German operator T-D1.</p> <p>APN to access the GPRS services provided by the German operator T-D1.</p>
---	---

10.2 AT^SISS Internet Service Setup Profile

AT^SISS serves to set up the necessary parameters in the Internet service profiles. Any service profile can then be used to control a data link in conjunction with AT^SISO, AT^SISC, AT^SISR and AT^SISW.

The AT^SISS read command requests the current settings of all Internet service profiles. One line is issued for every possible parameter of a given <srvParmTag> "srvType" value.

The AT^SISS write command specifies the parameters for a service profile identified by <srvProfileId>. At first the type of Internet service needs to be selected via <srvParmTag> value "srvType". This determines the applicability of all other <srvParmTag> values related to this "srvType" and sets their defaults. To change the settings the write command needs to be executed for each single <srvParmTag>.

The list below shows which <srvParmTag> parameters apply to each Internet service and which of them are mandatory or optional.

1. "Socket"
 - "address"
 - "conId" (mandatory)
Internet connection profile.
 - "alphabet" (optional)
2. "FTP"
 - "address"
 - "conId" (mandatory)
Internet connection profile.
 - "alphabet" (optional)
3. "HTTP"
 - "user" (optional)
 - "passwd" (optional)
 - "address" (mandatory)
 - "conId" (mandatory)
Internet connection profile.
 - "alphabet" (optional)
 - "hcContent" (optional)
 - "hcContLen" (optional)
 - "hcUsrAgent" (optional)
 - "hcMethod" (mandatory)
 - "hcProp" (optional)
 - "hcRedir" (optional)
 - "hcAuth" (optional)
4. "SMTP"
 - "user" (optional)
User name to be used for SMTP authentication.
 - "passwd" (optional)
Password to be used for SMTP authentication.
 - "address" (mandatory)
SMTP server address.
 - "tcpPort" (optional)
TCP port number of SMTP Server.
 - "conId" (mandatory)
Internet connection profile.
 - "alphabet" (optional)

- "smFrom" (mandatory)
Email sender ("MAIL FROM") address.
- "smRcpt" (mandatory)
Recipient ("RCPT TO") address.
- "smCC" (optional)
CC address of the email.
- "smSubj" (optional)
Subject content of the email.
- "smHdr" (optional)
Additional header fields of the email.
- "smAuth" (optional)
SMTP authentication control flag.

5. "POP3"

- "user" (mandatory)
- "passwd" (mandatory)
- "address" (mandatory)
POP3 server address.
- "tcpPort" (optional)
POP3 Server TCP Port Number.
- "conId" (mandatory)
Internet connection profile.
- "alphabet" (optional)
- "pCmd" (optional)
POP3 user command.
- "pNumber" (optional)
Message number argument.
- "pLength" (optional)
Maximum message length.
- "pDelFlag" (optional)
Delete message on server flag.

Syntax

Test Command

AT^SISS=?

Response(s)

OK

Read Command

AT^SISS?

Response(s)

^SISS: <srvProfileId>, <srvParmTag>, <srvParmValue>

OK

Write Command

AT^SISS=<srvProfileId>, <srvParmTag>, <srvParmValue>

Response(s)

OK

ERROR

+CME ERROR: <err>

PIN ASC0 ASC1 USB MUX1 MUX2 MUX3 Charge → Last

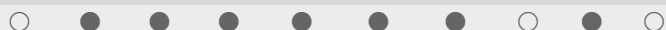

Parameter Description

<srvProfileId>^(num)

Internet service profile identifier.

<srvParmTag>^(str)

Internet service profile parameter.

"srvType"	Type of Internet service to be configured with consecutive usage of AT^SISS . For supported values of <srvParmValue> refer to <srvParmValue-srv-Type>.
"alphabet"	Selects the character set for input and output of string parameters within a profile. The selected value is bound to the specific profile. This means that different profiles may use different alphabets. For supported values of <srvParmValue> refer to <srvParmValue-alphabet>.
"user"	User name string <ol style="list-style-type: none"> 1. Socket Not applicable; set within "address" parameter. 2. FTP Not applicable; set within "address" parameter. 3. HTTP User name for the HTTP authentication mechanism. Currently only HTTP simple authentication is supported. 4. SMTP User name to be used for SMTP authentication. If SMTP authentication is disabled, i.e. "smAuth" flag not set, user name parameter will be ignored. 5. POP3 User name identifying a mailbox (i.e. mailbox name) which will be used to perform authentication with a POP3 server, e.g. "john.smith".
"passwd"	Password string <ol style="list-style-type: none"> 1. Socket Not applicable; set within "address" parameter. 2. FTP Not applicable; set within "address" parameter. 3. HTTP Password for the HTTP authentication mechanism. Currently HTTP simple authentication is supported only. 4. SMTP Password to be used for SMTP authentication. If SMTP authentication is disabled, i.e. "smAuth" flag not set, password parameter will be ignored. 5. POP3 Server/mailbox-specific password which will be used to perform authentication with a POP3 server.
"conId"	Internet connection profile to be used, for details refer AT^SICS .
"tcpPort"	TCP Port Number <ol style="list-style-type: none"> 1. Socket Not applicable; set within "address" parameter. 2. FTP Not applicable; set within "address" parameter. 3. HTTP Not applicable; set within "address" parameter.

If parameter is omitted the service connects to HTTP default port 80.

4. SMTP

SMTP server TCP port number

If this parameter is not set, SMTP default port number 25 is used.

5. POP3

POP3 server TCP port number

If this parameter is not set, POP3 default port number 110 is used.

“address“

String value, depending on the service type either a URL in the case of Socket, FTP and HTTP or an address in the case of SMTP and POP3:

1. Socket

- Socket type TCP client URL

"socketcp://host':remote tcpPort'[:disnagle='0|1'] "

"disnagle" is optional for disabling the TCP Nagle algorithm.

0: (default) Nagle algorithm is enabled.

1: Nagle algorithm is disabled.

- Socket type TCP server URL

"socketcp://listener:'local tcpPort' "

- Socket type UDP client URL

"sockudp://host':remote udpPort'[:size='byte']"

Parameter "size" (optional):

0: PDU size is variable.

1-1500: Fixed PDU size in bytes.

2. FTP

- FTP client URL (get)

"ftp://user':password'@host':tcpPort'/url-path' [:type='a|i|d'] "

Refer "IETF-RFC 1738".

- FTP client URL (put)

"ftpput://user':password'@host':tcpPort'/url-path'/element name' [:type='a|i'][:size='length'][:mode='u|a|d'] "

Used parameters:

"type": [a)scii | i)mage | d)irectory]

"mode": [u)nique | a)ppend | d)elete]

If "mode" is omitted "replace mode" is default setting. "d)elete" clears given 'element name'.

If "user" is omitted the string "anonymous" is selected for "user" and "password".

If "password" is omitted no server password request can be served.

If "tcpPort" is omitted the service connects to the FTP default port 21.

If "url-path" does not contain any character a detailed directory listing is requested.

If "url-path" ends with '/' a detailed directory listing is requested.

3. HTTP

- HTTP client URL

"http://server'/path':tcpPort' "

"server": FQDN or IP-address

"path": path of file or directory

"tcpPort": If parameter is omitted the service connects to HTTP default port 80.

Refer "IETF-RFC 2616".

4. SMTP

- SMTP server address.

Server address must be provided as IP address in standard dot-format (e.g. "192.168.1.2") or as server address name resolvable by a DNS server (e.g. "smtp.myserver.de").

5. POP3

- POP3 server address.
Server address must be provided as IP address in standard dot-format (e.g. "192.168.1.2") or as server address name resolvable by a DNS server (e.g. "pop3.myserver.de").

"hcContent"	Data for short post message with HTTP "Post" method (optional). If parameter is given no write is possible. If "write" is used for larger data this parameter needs to be empty.
"hcContLen"	Content length mandatory for HTTP "Post" requests, which send data from client to HTTP server (Upload). The content length must be set in the header of the HTTP "Post" request, before the data part is transferred. This parameter shall only be set for the "Post" method.
"hcUsrAgent"	The user agent string must be set by the application to identify the mobile. Usually operation system and software version info is set with this browser identifier.
"hcMethod"	HTTP method specification: 0=GET, 1=POST, 2=HEAD.
"hcProp"	Parameter for several HTTP settings. The general format is 'key': <space> 'value' "\0d\0a". Multiple settings can be given separated by "\0d\0a" sequences within the string. Possible 'key' values are defined at HTTP/1.1 Standard RFC 2616.
"hcRedir"	This flag controls the redirection mechanism of the TC65 acting as HTTP client. If the flag is set (1) the client automatically sends a new HTTP request if the server answers with a redirect code (range 30x).
"hcAuth"	If set (1) this flag determines that the HTTP client will automatically answer on authentication requests from the server with the current "passwd" and "user" parameter settings. If these parameters are not specified the TC65 will terminate the HTTP connection and send an indication to the TA.
"smFrom"	Email sender address ("MAIL FROM" address). A valid address parameter consists of local part and domain name delimited by a '@' character, e.g. "john.smith@somedomain.de".
"smRcpt"	Recipient address of the email ("RCPT TO" address). If multiple recipient addresses are to be supplied the comma character is used as delimiter to separate individual address values, e.g. "john.smith@somedomain.de,tom.meier@somedomain.de".
"smCC"	CC recipient address of the email. If multiple CC recipient addresses are to be supplied the comma character is used as delimiter to separate individual address values, e.g. "john.smith@somedomain.de,tom.meier@somedomain.de".
"smSubj"	Subject content of the email. If no subject is supplied the email will be sent with an empty subject.
"smHdr"	This parameter, if set, will be appended at the end of the email header section. Hence, it serves as a generic header field parameter which allows the user to provide any email header field. It is the user's responsibility to provide correct header fields! String of max. 512 characters. Example for multipart MIME messages: "Content-Type: multipart/mixed".
"smAuth"	SMTP authentication control flag. If disabled (<srvParmValue> "0" by default), TC65 performs action without SMTP authentication. If enabled (<srvParmValue> "1") authentication procedure with the SMTP server will be performed by means of supported authentication methods, using

values of "user" and "passwd" parameters. If TC65 and SMTP server are not able to negotiate an authentication mechanism supported by both parties, the TC65 continues action without authentication.
TC65 supports SMTP login authentication.

"pCmd"	POP3 user command to be executed by the POP3 service. For supported values of <srvParmValue> refer to <srvParmValue-pCmd> .
"pNumber"	Optional message number argument used by the POP3 commands List ("2"), Retrieve ("3") and Delete ("4"). For POP3 commands see <srvParmTag> value "pCmd".
"pLength"	Maximum message length (optional) Can be used to specify the length of the message(s) to be retrieved from or deleted on the POP3 server. If not given, the default value "0" is assumed, which means that there is no limit on the message size. A warning will be issued in the following cases: <ul style="list-style-type: none"> • If "pNumber" >0 and a specific message to be retrieved from / deleted on the server is longer than "pLength". • If "pNumber" = 0 and all messages to be retrieved from / deleted on the server are longer than "pLength". No warning will be issued in the following cases: <ul style="list-style-type: none"> • If there are no messages at all on the server. • If the server has message(s) below <i>and</i> above the "pLength" specified. In this case, the message(s) within the range of "pLength" can be successfully retrieved or deleted, but the message(s) above "pLength" remain on the server without any further notification given to the user. • Therefore, after retrieving / deleting messages, it is recommended to check the message status on the server. This can be done by adding a further POP3 service profile using the POP3 user command List ("2").
"pDelFlag"	Flag to be used with the POP3 user command Retrieve ("3"). Specifies whether or not to delete retrieved emails on the server (optional). For supported values of <srvParmValue> refer to <srvParmValue-pDelFlag> .

[<srvParmValue>](#)^(str)

Parameter value; type and supported content depend on related [<srvParmTag>](#).

[<srvParmValue-srvType>](#)^(str)

Supported Internet service type values in [<srvParmValue>](#) for [<srvParmTag>](#) value "srvType".

"Socket"	TC65 acting as client or server for TCP, or as client for UDP.
"FTP"	TC65 acting as FTP client.
"HTTP"	TC65 acting as HTTP client.
"SMTP"	TC65 acting as SMTP client.
"POP3"	TC65 acting as POP3 client.
"none"	Reset Internet service profile settings. Operation is not allowed if profile is in use, i.e. it was activated via AT^SISO .

[<srvParmValue-alphabet>](#)^(str)

Supported string parameter character set selections in [<srvParmValue>](#) for [<srvParmTag>](#) value "alphabet".

["0"]	Applicable character set is determined by current setting of AT+SCS .
"1"	International Reference Alphabet (IRA, seven bit ASCII).

<srvParmValue-pCmd>^(str)

Supported POP3 user command values in <srvParmValue> for <srvParmTag> value "pCmd".

- "1" Status command.
This command retrieves the "drop listing" of a POP3 server. A "drop listing" consists of a single line containing the number of messages in the maildrop list followed by the total size of the maildrop list in bytes. Each drop listing will be finished by a so-called "dotline", i.e. a new line with just a single dot.
- "2" List command.
If <srvParmTag> value "pNumber" is provided the command returns the "scan listing", consisting of a single line which contains the message number and the message size in bytes if the specified message exists in the maildrop list on the POP3 server.
If no such message exists on the server than the POP3 service issues an error response to the user.
If no argument was given with the List command the POP3 service returns a multi-line "scan listing". For each message on the maildrop list of the server the POP3 service returns a line containing the message number and its size in bytes. A final "dotline" will be printed at the end of the "scan listing".
If there are no messages on the maildrop list of the server, the POP3 service returns a positive response, i.e. it doesn't issue an error response, but the "scan listing" will be empty.
In either case, each scan listing will be finished by a so-called "dotline", i.e. a new line with just a single dot.
- "3" Retrieve command.
If <srvParmTag> value "pNumber" is set to a non-zero value this command retrieves the related message from the POP3 servers maildrop list.
If no such message exists on the server the POP3 service issues an error response to the user.
It depends on the parameter "pDelFlag" if the message will be deleted from the POP3 server upon successful retrieval.
If no argument was given to the "Retrieve" command the POP3 service returns all messages pending in the POP3 servers maildrop.
If there are no messages on the maildrop list of the server the POP3 service returns with a positive response, i.e. it doesn't issue an error response, but the returned list will be empty.
Each email will be finished by a so-called "dotline", i.e. a new line with just a single dot.
- "4" Delete command
If <srvParmTag> value "pNumber" is set to a non-zero value the command deletes the related message from the POP3 servers maildrop list. In fact, the message is marked as deleted on the server and will be deleted permanently if the POP3 service command executes successfully. In case an error has occurred, e.g. network loss, the message will not be deleted on the server even though the POP3 service command has been finished.
If no message number argument was given to the Delete command the POP3 service deletes all message from the POP3 servers maildrop list. In fact, the messages are marked as deleted on the server and will be deleted permanently if the POP3 service command executes successfully. In case an error has occurred, the messages will not be deleted on the server even though the POP3 service command has been finished.

<srvParmValue-pDelFlag>^(str)

Supported flag values in <srvParmValue> for <srvParmTag> value "pDelFlag". Only applicable if the profile contains the POP3 user command Retrieve ("3").

- ["0"] Messages will not be deleted on the server.
"1" Delete messages on the server which have been retrieved successfully.

10.3 AT^SISO Internet Service Open

The AT^SISO write command performs all necessary action to enable data transmission using AT^SISR or AT^SISW.

The AT^SISO read command requests the status of all Internet service profiles. One line is issued for every Internet service profile. Information following <srvParmTag> value "srvType" is issued only, if "srvType" was given a valid value via AT^SISS.

Syntax

<p>Test Command</p> <p>AT^SISO=?</p> <p>Response(s)</p> <p>OK</p>
<p>Read Command</p> <p>AT^SISO?</p> <p>Response(s)</p> <p>^SISO: <srvProfileId>, <srvParmTag>value "srvType" [, <srvState>, <socketState>, <rxCount>, <txCount>, <locAddr>, <remAddr>]</p> <p>OK</p>
<p>Write Command</p> <p>AT^SISO=<srvProfileId></p> <p>Response(s)</p> <p>OK</p> <p>ERROR</p> <p>+CME ERROR: <err></p>

PIN	ASC0	ASC1	USB	MUX1	MUX2	MUX3	Charge	→	Last
○	●	●	●	●	●	●	○	○	○

Unsolicited Result Code

Internet service status indication.

This URC may be issued after successful AT^SISO write command.

^SIS: <srvProfileId>, <urcCause>[, [, <urcInfoId>] [, <urcInfoText>]]

Parameter Description

<srvState> ^(num)	
Internet service state identifier.	
2	Engaged: Profile resources allocated, possibly parameter set via AT^SISS.
3	Connecting: Socket connection ongoing.
4	Connected: Socket connection valid.
5	Closing: Socket connection releasing.
<socketState> ^(num)	
Socket state identifier.	
1	Socket not assigned, i.e. no TCP/UDP connection active.
2	Socket assigned as CLIENT.

- 3 Socket assigned as LISTENER.
- 4 Socket assigned as SERVER.

<rxCount>^(num)

Number of bytes received via AT^SISR since last successful AT^SISO write command.

<txCount>^(num)

Number of bytes sent via AT^SISW since last successful AT^SISO write command.

<locAddr>^(str)

Local IP address in dotted-four-byte format and TCP port, separated by colon, e.g. "192.60.10.10:80".

<remAddr>^(str)

Remote IP address in dotted-four-byte format or evaluated DNS name and TCP port, separated by colon, e.g. "192.60.10.10:80" or "www.siemens.com:80".

<urcCause>^(num)

URC cause identifier.

- 0 Internet service error indication.
Error number is presented via <urcInfoId>, optionally additional information may be supplied via <urcInfoText>.
- 1 Indication of successful incoming Internet service client connection.
Connection is dynamically assigned to Internet service profile identifier issued in <urcInfoId>. The connection needs to be accepted via AT^SISO or rejected via AT^SISC.
Details regarding the connection may be requested via AT^SISO read command.
- 2 Indication of failed incoming Internet service client connection.
Client request was rejected automatically because no free Internet service profile was available.

<urcInfoId>^(num)

Information identifier related to <urcCause>.

<urcInfoText>^(str)

Information text related to <urcCause>.

10.4 AT^SISC Internet Service Close

The `AT^SISC` write command performs all necessary action to release all properties activated by `AT^SISO`.

Syntax

```

Test Command
AT^SISC=?
Response(s)
OK

Write Command
AT^SISC=<srvProfileId>[, <closeMode>]
Response(s)
OK
ERROR
+CME ERROR: <err>
    
```



Parameter Description

`<closeMode>`^(num)

Specifies the mode to close an Internet connection. The effect of the selected mode varies depending on the type of service.

0	Graceful
1	Immediate

10.4.1 Effect of parameter <closeMode>

Service type	Graceful	Immediate
Socket	The bearer will be closed after the transmission of remaining data has completed.	The bearer will be closed immediately. All remaining data are lost.
FTP	The bearer will be closed after the transmission of remaining data has completed.	The bearer will be closed immediately. All remaining data are lost.
HTTP	Connection will be immediately shut down.	Connection will be immediately shut down.
SMTP	The SMTP service sends some "closing" commands which are necessary to mark the email as successfully sent on the server. The service enters the <code><srvState></code> "Closing" and remains in this state until the final protocol exchange with the SMTP server has completed.	The SMTP service closes the network connection immediately. Email transfer is aborted. This mode can be used to cancel an SMTP operation.
POP3	Same as <code><closeMode></code> immediate: The network connection will be closed immediately.	The network connection will be closed immediately.

10.5 AT^SISR Internet Service Read Data

AT^SISR write command triggers reading data via the Internet service configured in `<srvProfileId>`. TC65 returns the amount of data which can be transferred:

- `<cnfReadLength>` value equal 0 indicates that the TC65 failed to enter online data mode. Details about the cause of failure is available using AT+CEER.
- `<cnfReadLength>` value greater than 0 indicates that the TC65 switches into online data mode to transfer the given number of bytes.

A URC "`^SISR: <srvProfileId>, <urcCauseId>`" will be issued if

- data is available after opening an Internet service or
- less data was confirmed (in `<cnfReadLength>`) than requested (with `<reqReadLength>`) during the last "Read Data" operation and new data is available.

This mechanism intends to avoid polling for fresh data by the TA.

Syntax

```

Test Command
AT^SISR=?
Response(s)
OK

Write Command
AT^SISR=<srvProfileId>, <reqReadLength>
Response(s)
^SISR: <srvProfileId>, <cnfReadLength>Number of data bytes are sent as specified by
<cnfReadLength>
OK
ERROR
+CME ERROR: <err>
    
```



Unsolicited Result Code

`^SISR: <srvProfileId>, <urcCauseId>`

Data availability status of Internet service configured in `<srvProfileId>` has changed.

Parameter Description

`<reqReadLength>`^(num)

Requested number of data bytes to be read via the Internet service configured in `<srvProfileId>`.

1...1500

`<cnfReadLength>`^(num)

Confirmed number of data bytes to be read via the Internet service configured in `<srvProfileId>`. This number may be less or equal to the value requested with `<reqReadLength>`. 0 value indicates that no data can be read.

<urcCauseId>^(num)

Data availability status change indication.

- 1 New data is available via [AT^SISR](#).
- 2 Data transfer has been finished and Internet service can be closed via [AT^SISC](#).

10.6 AT^SISW Internet Service Write Data

AT^SISW write command triggers writing data via the Internet service configured in <srvProfileId>. TC65 returns the amount of data which can be written:

- <cnfWriteLength> value equal 0 indicates that the TC65 failed to enter online data mode. Details about the cause of failure is available using AT+CEER.
- <cnfWriteLength> value greater than 0 indicates that the TC65 switches into online data mode to transfer the given number of bytes.

A URC "AT^SISW: <srvProfileId>, <urcCauseId>" will be issued if

- the TC65 is capable to send data after opening the Internet service or
- less transmission buffer space was confirmed (in <cnfWriteLength>) than requested (with <reqWriteLength>) or contained data has been sent via the Internet service.

This mechanism intends to avoid polling for free transmission buffer space by the TA.

Syntax

```

Test Command
AT^SISW=?
Response(s)
OK

Write Command
AT^SISW=<srvProfileId>, <reqWriteLength>
Response(s)
^SISW: <srvProfileId>, <cnfWriteLength>Number of data bytes are expected as specified by
<cnfWriteLength>
OK
ERROR
+CME ERROR: <err>
    
```

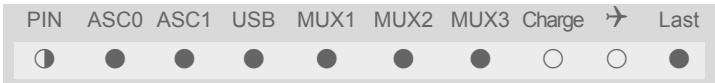

Unsolicited Result Code

^SISW: <srvProfileId>, <urcCauseId>

Data availability status of Internet service configured in <srvProfileId> has changed.

Parameter Description

<reqWriteLength>^(num)

Requested number of data bytes to be transmitted via the Internet service configured in <srvProfileId>. 1...1500

<cnfWriteLength>^(num)

Confirmed number of data bytes to be transmitted via the Internet service configured in <srvProfileId>. This number may be less or equal to the value requested with <reqWriteLength>. 0 value indicates that no data can be written.

<urcCauseId>^(num)

Data availability status change indication.

- 1 New data can be written via [AT^SISW](#).
- 2 Data transfer has been finished and Internet service can be closed via [AT^SISC](#).

11. GPRS Commands

This chapter describes AT Commands that a TE (Terminal Equipment, e.g. an application running on a controlling PC) may use to control the TC65 acting as GPRS Mobile Termination (MT). Please use chapter "[Using GPRS AT commands \(Examples\)](#)" as a first guidance.

11.1 AT+CGACT PDP context activate or deactivate

Syntax

<p>Test Command</p> <pre>AT+CGACT=?</pre> <p>Response(s)</p> <pre>+CGACT: (list of supported <state>s) OK</pre>	
<p>Read Command</p> <pre>AT+CGACT?</pre> <p>Response(s)</p> <pre>+CGACT: <cid>, <state> [+CGACT: <cid>, <state>] ... OK</pre>	
<p>Write Command</p> <pre>AT+CGACT=[<state>[, <cid>[, <cid>]]]</pre> <p>Response(s)</p> <pre>OK ERROR +CME ERROR</pre>	
<p>Reference(s)</p> <p>GSM 07.07</p>	

Command Description

The test command is used for requesting information on the supported PDP context activation states.

The read command returns the current activation states for all the defined PDP contexts.

The write command is used to activate or deactivate the specified PDP context(s). After the command has completed, the MT remains in V.250 command state. If any PDP context is already in the requested state, the state for that context remains unchanged. If the MT is not GPRS attached when the activation form of the command is executed, the MT first performs a GPRS attach and then attempts to activate the specified contexts. If no **<cid>**s are specified the activation/deactivation form of the command activates/deactivates all defined contexts.

Parameter Description

<state> ^(num)	
Indicates the state of PDP context activation.	
0	deactivated
[1]	activated

<cid>^(num)

PDP Context Identifier is a numeric parameter which specifies a particular PDP context definition. The parameter is local to the TE-MT interface and is used in other PDP context related commands.

1...2

Notes

- [ATH](#) will deactivate any PDP context.
- If the MT is in dedicated mode, the write command returns "+CME ERROR: operation temporary not allowed".
- A maximum of 2 contexts can be activated at the same time, no matter on which interface. Trying to activate more than 2 contexts will cause "+CME ERROR: operation temporary not allowed". Note that, depending on the provider, the number of activated contexts may be further restricted. Remember that contexts may be activated implicitly by using the [ATD*98#](#) or [ATD*99#](#) GPRS compatibility commands without specifying a <cid>.
- If an activated context will be deactivated without using the command [AT+CGACT](#), then the result code "NO CARRIER" will be issued to indicate the context deactivation. This happens for example if the context deactivation is forced by the network or if deactivation results from a network deregistration with [AT+COPS=2](#).

11.2 AT+CGANS Manual response to a network request for PDP context activation

Syntax

<p>Test Command</p> <p>AT+CGANS=?</p> <p>Response(s)</p> <p>+CGANS: (list of supported <response>s), (list of supported <L2P>s)</p> <p>OK</p>	
<p>Write Command</p> <p>AT+CGANS=[<response>[, <L2P>[, <cid>]]]</p> <p>Response(s)</p> <p>CONNECT</p> <p>NO CARRIER</p> <p>ERROR</p> <p>+CME ERROR</p>	
<p>Reference(s)</p> <p>GSM 07.07</p>	

Command Description

The write command requests the MT to respond to a network request for GPRS PDP context activation which has been signaled to the TE by the RING or CRING unsolicited result code. The <response> parameter allows the TE to accept or reject the request.

Parameter Description

<response> ^(num)	
[0]	the request is rejected and the MT returns OK to the TE
1	accept and request that the PDP context be activated
<L2P> ^(str)	
a string parameter which indicates the layer 2 protocol to be used (see AT+CGDATA command)	
<cid> ^(num)	
a numeric parameter which specifies a particular PDP context definition (see AT+CGDCONT command).	

Note

- If <response> is 1, the following procedure is followed by the MT:
If the <L2P> parameter value is unacceptable to the MT, the MT will return an ERROR or +CME ERROR response. Otherwise, the MT issues the intermediate result code CONNECT and enters V.250 online data state.
A <cid> may be specified for use in the context activation request.
During the PDP startup procedure the MT has the PDP type and the PDP address provided by the network in the Request PDP context activation message. If this is in conflict with the information provided by a specified <cid>, the command will fail. There will be no conflict, if the PDP type matches exactly and the PDP address given by the context definition for <cid> is empty or matches exactly with the address specified with the network PDP context activation message.
The context will be activated using the values for PDP type and address provided by the network, together with all other information found in the PDP context definition. An APN may or may not be required, depending on the application.

If no <cid> is given or if there is no matching context definition, the MT will attempt to activate the context using the values for PDP type and address provided by the network. The other parameters will be set to their default values (see [AT+CGDCONT](#)).

If activation is successful, data transfer may proceed.

After data transfer is complete, and the layer 2 protocol termination procedure has completed successfully, the V.250 command state is reentered and the MT returns the final result code OK.

In the event of an erroneous termination or a failure to start up, the V.250 command state is re-entered and the MT returns the final result code NO CARRIER, or if enabled, +CME ERROR. Attach, activate and other errors may be reported. It is also an error to issue the [AT+CGANS](#) command when there is no pending network request.

The command may be used in both normal and modem compatibility modes.

11.3 AT+CGATT GPRS attach or detach

Syntax

<p>Test Command</p> <p>AT+CGATT=?</p> <p>Response(s)</p> <p>+CGATT: (list of supported <state>s)</p> <p>OK</p>	
<p>Read Command</p> <p>AT+CGATT?</p> <p>Response(s)</p> <p>+CGATT: <state></p> <p>OK</p>	
<p>Write Command</p> <p>AT+CGATT=[<state>]</p> <p>Response(s)</p> <p>OK</p> <p>ERROR</p> <p>+CME ERROR</p>	
<p>Reference(s)</p> <p>GSM 07.07</p>	<p>PIN ASC0 ASC1 USB MUX1 MUX2 MUX3 Charge → Last</p> <p>● ● ● ● ● ● ● ○ ○ ○</p>

Command Description

The test command is used for requesting information on the supported GPRS service states.

The read command returns the current GPRS service state.

The write command is used to attach the MT to, or detach the MT from the GPRS service. After the command has completed, the MT remains in V.250 command state. If the MT is already in the requested state, the command is ignored and the OK response is returned. Any active PDP contexts will be automatically deactivated when the attachment state changes to detached.

Parameter Description

<state>^(num)

Indicates the state of GPRS attachment.

0 ^(P)	detached
[1]	attached

Notes

- If the MT is in dedicated mode, write command returns "+CME ERROR: operation temporary not allowed".
- When the module is GPRS attached and a PLMN reselection occurs to a non-GPRS network or to a network where the SIM is not subscribed to for using GPRS, the resulting GMM (GPRS mobility management) state according to GSM 24.008 is REGISTERED/NO CELL, meaning that the read command will still show <state>=1.

11.4 AT+CGAUTO Automatic response to a network request for PDP context activation

Syntax

<p>Test Command</p> <pre>AT+CGAUTO=?</pre> <p>Response(s)</p> <pre>+CGAUTO: (list of supported <n>s) OK</pre>	
<p>Read Command</p> <pre>AT+CGAUTO?</pre> <p>Response(s)</p> <pre>+CGAUTO: <n> OK</pre>	
<p>Write Command</p> <pre>AT+CGAUTO=[<n>]</pre> <p>Response(s)</p> <pre>OK ERROR +CME ERROR</pre>	
<p>Reference(s)</p> <p>GSM 07.07</p>	<p>PIN ASC0 ASC1 USB MUX1 MUX2 MUX3 Charge → Last</p> <p>● ● ● ● ● ● ○ ○ ○</p>

Command Description

The test command returns the values of `<n>` supported by the MT as a compound value.

The write command disables or enables an automatic positive response (auto-answer) to the receipt of a Request PDP Context Activation message from the network. It also provides control over the use of the V.250 basic commands [ATS0](#), [ATA](#) and [ATH](#) for handling network requests for PDP context activation.

Parameter Description

<code><n></code> ^(num)	
0	Disable automatic response for network requests for GPRS PDP context activation. GPRS network requests are manually accepted or rejected by the AT+CGANS command.
1	Enable automatic response for network requests for GPRS PDP context activation. GPRS requests are automatically accepted according to the description below.
3 ^{(&F)(P)}	Modem compatibility mode. The automatic acceptance of both GPRS and incoming CSD calls is controlled by the ATS0 command. Manual control uses the ATA and ATH commands, respectively, to accept or reject GPRS network requests or incoming CSD calls.

Notes

- It is allowed to have different [AT+CGAUTO](#) settings on different interfaces.
- When the [AT+CGAUTO=0](#) command is received, the MT will not perform a GPRS detach if it is attached. Subsequently, when the MT announces a network request for PDP context activation by issuing the URC RING or CRING, the TE may manually accept or reject the request by issuing the [AT+CGANS](#) command or may simply ignore the network request.

-
- When the `AT+CGAUTO=1` command is received, the MT will attempt to perform a GPRS attach if it is not yet attached. Failure will result in ERROR or, if enabled +CME ERROR being returned to the TE. Subsequently, the MT announces a network request for PDP context activation by issuing the URC RING to the TE, followed by the intermediate result code CONNECT. The MT then enters V.250 online data state and follows the same procedure as it would after having received a +CGANS=1 with no <L2P> or <cid> values specified.
 - If a GPRS attach will be initiated by this command and the MT is not able to attach for more than 385 seconds (timer T3310 expired), command returns with "ERROR" or "+CME ERROR: unknown", but MT is still trying to attach and the requested automatic mode <n> is in use.
 - If a network request for PDP context activation is answered automatically and if another AT command is issued at the same time on the same interface, then this AT command is not executed. Any response belongs to the automatic context activation procedure. If the AT command which caused the collision was a circuit switched data call, the CONNECT response does not belong to this data call but to the GPRS. This can be detected if `ATX` is not set to 0. CS data call will issue CONNECT <text>, GPRS will issue CONNECT only.

11.5 AT+CGDATA Enter data state

Syntax

Test Command	
AT+CGDATA=?	
Response(s)	
+CGDATA: (list of supported <L2P>s)	
OK	
Write Command	
AT+CGDATA=[<L2P>[, <cid>[, <cid>]]]	
Response(s)	
CONNECT	
NO CARRIER	
ERROR	
+CME ERROR	
Reference(s)	
GSM 07.07	
	PIN ASC0 ASC1 USB MUX1 MUX2 MUX3 Charge → Last
	● ● ● ● ● ● ● ○ ○ ●

Command Description

The test command is used for requesting information on the supported layer 2 protocols to be used between the TE and MT.

The write command causes the MT to perform all actions which are necessary to establish communication between the TE and the network using one or more GPRS PDP types. This may include performing a GPRS attach and one or more PDP context activations. Commands following the [AT+CGDATA](#) command in the AT command line will not be processed by the MT.

If no <cid> is given or if there is no matching context definition, the MT will attempt to activate the context with PDP type IP and all other context parameters set to their default values (see [AT+CGDCONT](#), [AT+CGQREQ](#), [AT+CGQMIN](#)).

If the <L2P> parameter is omitted, the layer 2 protocol is unspecified and PPP will be used.

If the write command is successful, the MT issues the intermediate result code CONNECT and enters V.250 online data state.

After data transfer is complete, and the layer 2 protocol termination procedure has completed successfully, the command state is reentered and the MT returns the final result code OK.

If the <L2P> parameter value is unacceptable to the MT, the MT returns ERROR or +CME ERROR.

In the event of erroneous termination or a failure to start up, the command state is reentered and the MT returns NO CARRIER, or if enabled +CME ERROR.

Parameter Description

<L2P>^(str)
Layer 2 protocol to be used between the TE and MT.
[“PPP”] layer 2 protocol PPP

<cid>^(num)
Parameter specifies a particular PDP context definition. The parameter is local to the TE-MT interface and is used in other PDP context-related commands.
1...2

Notes

- If the MT is in dedicated mode, write command returns "+CME ERROR: operation temporary not allowed".
- It is possible to leave the GPRS data mode and enter the command mode by using the V.250 command `+++`. By using the command `AT+CGDATA` again, the data mode is reentered. Which context is used to return to data mode, depends on the supplied parameter `<cid>`.
If no `<cid>` is specified, this is equivalent to using the V.250 command `ATO`, which is usable for GPRS connections too. In this case the first context will be used, which is active and already in data mode since it has been activated.
It is possible to use `AT+CGDATA` to enter the data mode for a context, which is not yet in data mode since it has been activated. With `ATO` this is not possible.

11.5.1 Automatic deactivation of PDP context during dial-up PPP

When using the `AT+CGDATA` write command or `ATD*99#` or `ATD*98#` the MT issues the intermediate result code `CONNECT` and enters V.250ter online data state. In V.250 online data state, first some LCP protocol exchange between MT and TE is performed to set up the PPP link. After successfully establishing the PPP link, the MT performs the PDP context activation procedure if the context is not already activated. As a result, the MT is in a "PDP context activated" state within the PLMN, the PPP link is established on the mobile side and the mobile is ready for IP data transfer.

If the TE wants to close the LCP link the MT may perform an LCP termination request procedure on PPP level. After this LCP termination procedure the MT deactivates the PDP context automatically and the MT returns to V.250 command mode and issues the final result code `NO CARRIER`.

During the implicit PDP context deactivation procedure after LCP termination the TE may change into V.250 command state (e.g. by using `+++` or by toggling DTR if `AT&D` is set to 1) before the result `NO CARRIER` occurs. In this case the application should not try to deactivate the PDP context by using the commands `AT+CGACT` or `ATH`. If DTR is configured to disconnect data connections (`AT&D2`), then the application should not toggle DTR during the implicit PDP context deactivation and before "NO CARRIER" is received.

11.6 AT+CGDCONT Define PDP Context

Syntax

<p>Test Command</p> <pre>AT+CGDCONT=?</pre> <p>Response(s)</p> <pre>+CGDCONT: (range of supported<cid>s), <PDP_type>, , (list of supported <d_comp>s), (list of supported <h_comp>s) OK ERROR +CME ERROR</pre>	
<p>Read Command</p> <pre>AT+CGDCONT?</pre> <p>Response(s)</p> <pre>[+CGDCONT: <cid>, <PDP_type>, <APN>, <PDP_addr>, <d_comp>, <h_comp>] [+CGDCONT: ...] OK ERROR +CME ERROR</pre>	
<p>Write Command</p> <pre>AT+CGDCONT=[<cid>[, <PDP_type>[, <APN>[, <PDP_addr>[, <d_comp>[, <h_comp>]]]]]</pre> <p>Response(s)</p> <pre>OK ERROR +CME ERROR</pre>	
<p>Reference(s)</p> <p>GSM 07.07</p>	<p>PIN ASC0 ASC1 USB MUX1 MUX2 MUX3 Charge Last</p> <p><input type="radio"/> <input type="radio"/> <input type="radio"/> <input type="radio"/> <input type="radio"/> <input type="radio"/> <input type="radio"/> <input type="radio"/> <input type="radio"/> <input type="radio"/> <input type="radio"/></p>

Command Description

The test command returns supported values as a compound value.

The read command returns the current settings for each defined PDP context.

The write command specifies the parameters for a PDP context identified by the context identifier *<cid>*. The number of contexts that may be in a defined state at the same time is given by the range returned by the test command. A special form of the write command (`AT+CGDCONT=<cid>`) causes the values for context *<cid>* to become undefined.

Parameter Description

<p><i><cid></i>^(num)</p> <p>PDP Context Identifier</p> <p>Parameter specifies a particular PDP context definition. The parameter is local to the TE-MT interface and is used in other PDP context-related commands.</p> <p>1...2</p>
<p><i><PDP_type></i>^(str)</p> <p>Packet Data Protocol type</p> <p>Specifies the type of the packet data protocol.</p> <p>"IP" Internet Protocol (IETF STD 5)</p>

<APN>^(str)

Access Point Name

The logical name that is used to select the GGSN or the external packet data network. If the value is null or omitted, then the subscription value will be requested.

<PDP_addr>^(str)

Packet Data Protocol address

Identifies the MT in the address space applicable to PDP (e.g. IP V4 address for PDP type IP). If the value is null or omitted, then a value may be provided by the TE during the PDP startup procedure or, failing that, a dynamic address will be requested.

<d_comp>^(num)

Data Compression

Controls the PDP data compression (applicable for Subnetwork Dependent Convergence Protocol (SNDP) only) 3GPP TS 44.065

[0] off

<h_comp>^(num)

Header Compression

Controls the PDP header compression 3GPP TS 44.065, 3GPP TS 25.323

[0] off

1 on

Notes

- The MT supports PDP type IP only.
- [AT&F](#) and [ATZ](#) will undefine every context which is not active or not online.

Parameter Description

<cid>^(num)

Parameter specifies a particular PDP context definition. The parameter is local to the TE-MT interface and is used in other PDP context-related commands.

1...2

<Traffic class>^(num)

0	conversational
1	streaming
2	interactive
3	background
[4]	subscribed value

<Maximum bitrate UL>^(num)

This parameter indicates the maximum number of kbits/s delivered to UMTS (up-link traffic) at a SAP. As an example a bitrate of 32kbit/s would be specified as 32 (e.g. [AT+CGEQMIN=...,32,...](#)).

[0]	subscribed value
1...63	
64...128	(value needs to be divisible by 8 without remainder)
256	
512	

<Maximum bitrate DL>^(num)

This parameter indicates the maximum number of kbits/s delivered by UMTS (down-link traffic) at a SAP. As an example a bitrate of 32kbit/s would be specified as 32 (e.g. [AT+CGEQMIN=...,32,...](#)).

[0]	subscribed value
1...63	
64...256	(value needs to be divisible by 8 without remainder)
512	

<Guaranteed bitrate UL>^(num)

This parameter indicates the guaranteed number of kbits/s delivered to UMTS (up-link traffic) at a SAP (provided that there is data to deliver). As an example a bitrate of 32kbit/s would be specified as 32 (e.g. [AT+CGEQMIN=...,32,...](#)).

[0]	subscribed value
1...63	
64...128	(value needs to be divisible by 8 without remainder)

<Guaranteed bitrate DL>^(num)

This parameter indicates the guaranteed number of kbits/s delivered by UMTS (down-link traffic) at a SAP (provided that there is data to deliver). As an example a bitrate of 32kbit/s would be specified as 32 (e.g. [AT+CGEQMIN=...,32,...](#)).

[0]	subscribed value
1...63	
64...256	(value needs to be divisible by 8 without remainder)

<Delivery order>^(num)

This parameter indicates whether the UMTS bearer shall provide in-sequence SDU delivery or not.

0	no
1	yes
[2]	subscribed value

<Maximum SDU size>^(num)

This parameter indicates the maximum allowed SDU size in octets.

[0]	subscribed value
10...1520	(value needs to be divisible by 10 without remainder)
1502	

<SDU error ratio>^(str)

This parameter indicates the target value for the fraction of SDUs lost or detected as erroneous. SDU error ratio is defined only for conforming traffic. The value is specified as "mEe". As an example a target SDU error ratio of $5 \cdot 10^{-3}$ would be specified as "5E3" (e.g. [AT+CGEQMIN=..., "5E3", ...](#)).

["0E0"]	subscribed value
"1E2"	
"7E3"	
"1E3"	
"1E4"	
"1E5"	
"1E6"	
"1E1"	

<Residual bit error ratio>^(str)

This parameter indicates the target value for the undetected bit error ratio in the delivered SDUs. If no error detection is requested, Residual bit error ratio indicates the bit error ratio in the delivered SDUs. The value is specified as "mEe". As an example a target residual bit error ratio of $5 \cdot 10^{-3}$ would be specified as "5E3" (e.g. [AT+CGEQMIN=..., "5E3", ...](#)).

["0E0"]	subscribed value
"5E2"	
"1E2"	
"5E3"	
"4E3"	
"1E3"	
"1E4"	
"1E5"	
"1E6"	
"6E8"	

<Delivery of erroneous SDUs>^(num)

This parameter indicates whether SDUs detected as erroneous shall be delivered or not.

0	no
---	----

1	yes
2	no detect
[3]	subscribed value

<Transfer delay>^(num)

This parameter indicates the targeted time between request to transfer an SDU at one SAP to its delivery at the other SAP, in milliseconds.

[0]	subscribed value
10...150	(value needs to be divisible by 10 without remainder)
200...950	(value needs to be divisible by 50 without remainder)
1000...4000	(value needs to be divisible by 100 without remainder)

<Traffic handling priority>^(num)

This parameter specifies the relative importance for handling of all SDUs belonging to the UMTS bearer compared to the SDUs of the other bearers.

[0]	subscribed
1	
2	
3	

<PDP_type>^(str)

Packet Data Protocol Type

“IP“

Notes

- If parameters are not defined, the parameter default values depend on the HLR-stored subscribed default values.
- Definitions of parameters can be found in 3GPP TS 23.107

11.8 AT+CGEQREQ 3G Quality of Service Profile (Requested)

Syntax

<p>Test Command</p> <pre>AT+CGEQREQ=?</pre> <p>Response(s)</p> <pre>+CGEQREQ: <PDP_type>, (list of supported <Traffic class>s), (list of supported <Maximum bitrate UL>s), (list of supported <Maximum bitrate DL>s), (list of supported <Guaranteed bitrate UL>s), (list of supported <Guaranteed bitrate DL>s), (list of supported <Delivery order>s), (list of supported <Maximum SDU size>s), (list of supported <SDU error ratio>s), (list of supported <Residual bit error ratio>s), (list of supported <Delivery of erroneous SDUs>s), (list of supported <Transfer delay>s), (list of supported <Traffic handling priority>s)</pre> <p>OK</p>																					
<p>Read Command</p> <pre>AT+CGEQREQ?</pre> <p>Response(s)</p> <pre>[+CGEQREQ: <cid>, (list of supported <Traffic class>s), (list of supported <Maximum bitrate UL>s), (list of supported <Maximum bitrate DL>s), (list of supported <Guaranteed bitrate UL>s), (list of supported <Guaranteed bitrate DL>s), (list of supported <Delivery order>s), (list of supported <Maximum SDU size>s), (list of supported <SDU error ratio>s), (list of supported <Residual bit error ratio>s), (list of supported <Delivery of erroneous SDUs>s), (list of supported <Transfer delay>s), (list of supported <Traffic handling priority>s)]</pre> <p>[+CGEQREQ: ...]</p>																					
<p>Write Command</p> <pre>AT+CGEQREQ=[<cid>[, <Traffic class>[, <Maximum bitrate UL>[, <Maximum bitrate DL>[, <Guaranteed bitrate UL>[, <Guaranteed bitrate DL>[, <Delivery order>[, <Maximum SDU size>[, <SDU error ratio>[, <Residual bit error ratio>[, <Delivery of erroneous SDUs>[, <Transfer delay>[, <Traffic handling priority>]]]]]]]]]]]]]]]</pre> <p>Response(s)</p> <pre>OK ERROR +CME ERROR</pre>																					
<p>Reference(s)</p> <p>3GPP TS 27.007</p>	<table border="1"> <thead> <tr> <th>PIN</th> <th>ASC0</th> <th>ASC1</th> <th>USB</th> <th>MUX1</th> <th>MUX2</th> <th>MUX3</th> <th>Charge</th> <th>→</th> <th>Last</th> </tr> </thead> <tbody> <tr> <td>●</td> <td>●</td> <td>●</td> <td>●</td> <td>●</td> <td>●</td> <td>●</td> <td>○</td> <td>→</td> <td>○</td> </tr> </tbody> </table>	PIN	ASC0	ASC1	USB	MUX1	MUX2	MUX3	Charge	→	Last	●	●	●	●	●	●	●	○	→	○
PIN	ASC0	ASC1	USB	MUX1	MUX2	MUX3	Charge	→	Last												
●	●	●	●	●	●	●	○	→	○												

Command Description

The test command returns values supported as a compound value.
 The read command returns the current settings for each defined context.
 The write command allows the TE to specify a Quality of Service Profile for the context identified by the (local) context identification parameter <cid> which is used when the MT sends an Activate PDP Context Request message to the network.
 A special form of the write command, AT+CGEQREQ=<cid> causes the requested profile for context number <cid> to become undefined.
 AT&F and ATZ will undefine the QoS profiles of every context which is not active or not online.

Parameter Description

<cid>^(num)

Parameter specifies a particular PDP context definition. The parameter is local to the TE-MT interface and is used in other PDP context-related commands.

1...2

<Traffic class>^(num)

0	conversational
1	streaming
2	interactive
3	background
[4]	subscribed value

<Maximum bitrate UL>^(num)

This parameter indicates the maximum number of kbits/s delivered to UMTS (up-link traffic) at a SAP. As an example a bitrate of 32kbit/s would be specified as 32 (e.g. [AT+CGEQREQ=...,32,...](#)).

[0]	subscribed value
1...63	
64...128	(value needs to be divisible by 8 without remainder)
256	
512	

<Maximum bitrate DL>^(num)

This parameter indicates the maximum number of kbits/s delivered by UMTS (down-link traffic) at a SAP. As an example a bitrate of 32kbit/s would be specified as 32 (e.g. [AT+CGEQREQ=...,32,...](#)).

[0]	subscribed value
1...63	
64...256	(value needs to be divisible by 8 without remainder)
512	

<Guaranteed bitrate UL>^(num)

This parameter indicates the guaranteed number of kbits/s delivered to UMTS (up-link traffic) at a SAP (provided that there is data to deliver). As an example a bitrate of 32kbit/s would be specified as 32 (e.g. [AT+CGEQREQ=...,32,...](#)).

[0]	subscribed value
1...63	
64...128	(value needs to be divisible by 8 without remainder)

<Guaranteed bitrate DL>^(num)

This parameter indicates the guaranteed number of kbits/s delivered by UMTS (down-link traffic) at a SAP (provided that there is data to deliver). As an example a bitrate of 32kbit/s would be specified as 32 (e.g. [AT+CGEQREQ=...,32,...](#)).

[0]	subscribed value
1...63	
64...256	(value needs to be divisible by 8 without remainder)

<Delivery order>^(num)

This parameter indicates whether the UMTS bearer shall provide in-sequence SDU delivery or not.

0	no
1	yes
[2]	subscribed value

<Maximum SDU size>^(num)

This parameter indicates the maximum allowed SDU size in octets.

[0]	subscribed value
10...1520	(value needs to be divisible by 10 without remainder)
1502	

<SDU error ratio>^(str)

This parameter indicates the target value for the fraction of SDUs lost or detected as erroneous. SDU error ratio is defined only for conforming traffic. The value is specified as "mEe". As an example a target SDU error ratio of $5 \cdot 10^{-3}$ would be specified as "5E3" (e.g. [AT+CGEQREQ=..., "5E3", ...](#)).

["0E0"]	subscribed value
"1E2"	
"7E3"	
"1E3"	
"1E4"	
"1E5"	
"1E6"	
"1E1"	

<Residual bit error ratio>^(str)

This parameter indicates the target value for the undetected bit error ratio in the delivered SDUs. If no error detection is requested, Residual bit error ratio indicates the bit error ratio in the delivered SDUs. The value is specified as "mEe". As an example a target residual bit error ratio of $5 \cdot 10^{-3}$ would be specified as "5E3" (e.g. [AT+CGEQREQ=..., "5E3", ...](#)).

["0E0"]	subscribed value
"5E2"	
"1E2"	
"5E3"	
"4E3"	
"1E3"	
"1E4"	
"1E5"	
"1E6"	
"6E8"	

<Delivery of erroneous SDUs>^(num)

This parameter indicates whether SDUs detected as erroneous shall be delivered or not.

0	no
1	yes
2	no detect
[3]	subscribed value

<Transfer delay>^(num)

This parameter indicates the targeted time between request to transfer an SDU at one SAP to its delivery at the other SAP, in milliseconds.

[0]	subscribed value
10...150	(value needs to be divisible by 10 without remainder)
200...950	(value needs to be divisible by 50 without remainder)
1000...4000	(value needs to be divisible by 100 without remainder)

<Traffic handling priority>^(num)

This parameter specifies the relative importance for handling of all SDUs belonging to the UMTS bearer compared to the SDUs of the other bearers.

[0]	subscribed
1	
2	
3	

<PDP_type>^(str)

Packet Data Protocol Type

“IP“

Notes

- If parameters are not defined, the parameter default values depend on the HLR-stored subscribed default values.
- Definitions of parameters can be found in 3GPP TS 23.107

11.9 AT+CGPADDR Show PDP address

Syntax

<p>Test Command</p> <pre>AT+CGPADDR=?</pre> <p>Response(s)</p> <pre>[+CGPADDR: (list of defined <cid>s)] OK</pre>	<p>Write Command</p> <pre>AT+CGPADDR=[<cid>[,<cid>]]</pre> <p>Response(s)</p> <pre>[+CGPADDR: <cid>, <PDP_address>] [+CGPADDR: <cid>, <PDP_address>] OK ERROR +CME ERROR</pre>																				
<p>Reference(s)</p> <p>GSM 07.07</p>	<table border="1"> <tr> <td>PIN</td> <td>ASC0</td> <td>ASC1</td> <td>USB</td> <td>MUX1</td> <td>MUX2</td> <td>MUX3</td> <td>Charge</td> <td>✈</td> <td>Last</td> </tr> <tr> <td>●</td> <td>●</td> <td>●</td> <td>●</td> <td>●</td> <td>●</td> <td>●</td> <td>○</td> <td>●</td> <td>○</td> </tr> </table>	PIN	ASC0	ASC1	USB	MUX1	MUX2	MUX3	Charge	✈	Last	●	●	●	●	●	●	●	○	●	○
PIN	ASC0	ASC1	USB	MUX1	MUX2	MUX3	Charge	✈	Last												
●	●	●	●	●	●	●	○	●	○												

Command Description

The test command returns a list of defined [<cid>s](#).

The write command returns a list of PDP addresses for the specified context identifiers. If no [<cid>](#) is specified, the addresses for all defined contexts are returned.

Parameter Description

[<cid>](#)^(num)

A numeric parameter which specifies a particular PDP context definition (see [AT+CGDCONT](#) command).

[<PDP_address>](#)^(str)

A string that identifies the MT in the address space applicable to the PDP. The address may be static or dynamic.

Note

- If no [<cid>](#) is specified, the write command will return a list of all defined contexts.

11.10 AT+CGQMIN Quality of Service Profile (Minimum acceptable)

Syntax

<p>Test Command</p> <pre>AT+CGQMIN=?</pre> <p>Response(s)</p> <pre>+CGQMIN: <PDP_type>, (list of supported <precedence>s), (list of supported <delay>s), (list of supported <reliability>s), (list of supported <peak>s), (list of supported <mean>s) OK ERROR +CME ERROR</pre>	
<p>Read Command</p> <pre>AT+CGQMIN?</pre> <p>Response(s)</p> <pre>[+CGQMIN: <cid>, <precedence>, <delay>, <reliability>, <peak>, <mean>] [+CGQMIN: ...] OK ERROR +CME ERROR</pre>	
<p>Write Command</p> <pre>AT+CGQMIN=[<cid>[, <precedence>[, <delay>[, <reliability>[, <peak>[, <mean>]]]]]]</pre> <p>Response(s)</p> <pre>OK ERROR +CME ERROR</pre>	
<p>Reference(s)</p> <p>GSM 07.07</p>	

Command Description

The test command returns values supported as a compound value. If the MT supports several PDP types, the parameter value ranges for each PDP type are returned on a separate line.

The read command returns the current settings for each defined context.

This command allows the TE to specify a minimum acceptable profile which is checked by the MT against the negotiated profile returned in the Activate PDP Context Accept message.

The set command specifies a profile for the context identified by the (local) context identification parameter, `<cid>`.

A special form of the set command, `AT+CGQMIN= <cid>` causes the minimum acceptable profile for context number `<cid>` to become undefined. In this case no check is made against the negotiated profile.

`AT&F` and `ATZ` will undefine the minimum QoS profiles of every context which is not active or not online.

Parameter Description

`<cid>`^(num)

Parameter specifies a particular PDP context definition. The parameter is local to the TE-MT interface and is used in other PDP context-related commands.

1...2

<precedence>^(num)

Precedence class

- [0] network subscribed value
- 1 High Priority
Service commitments shall be maintained ahead of precedence classes 2 and 3
- 2 Normal priority
Service commitments shall be maintained ahead of precedence class 3
- 3 Low priority
Service commitments shall be maintained

<delay>^(num)

Delay class

The delay parameter defines the end-to-end transfer delay incurred in the transmission of SDUs through the GPRS network(s).

- [0] network subscribed value
- 1..4 SDU size: 128 octets:

Delay Class	Mean Transfer Delay	95 percentile
1 (Predictive)	<0.5	<1.5
2 (Predictive)	<5	<25
3 (Predictive)	<50	<250
4 (Best Effort)	Unspecified	

SDU size: 1024 octets:

Delay Class	Mean Transfer Delay	95 percentile
1 (Predictive)	<0.5	<1.5
2 (Predictive)	<5	<25
3 (Predictive)	<50	<250
4 (Best Effort)	Unspecified	

<reliability>^(num)

Reliability class

- [0] network subscribed value
- 1 Non real-time traffic, error-sensitive application that cannot cope with data loss
- 2 Non real-time traffic, error-sensitive application that can cope with infrequent data loss
- 3 Non real-time traffic, error-sensitive application that can cope with data loss, GMM/SM, and SMS
- 4 Real-time traffic, error-sensitive application that can cope with data loss
- 5 Real-time traffic, error non-sensitive application that can cope with data loss

<peak>^(num)

Peak throughput class (in octets per second).

- [0] network subscribed value

1	Up to 1 000 (8 kbit/s).
2	Up to 2 000 (16 kbit/s).
3	Up to 4 000 (32 kbit/s).
4	Up to 8 000 (64 kbit/s).
5	Up to 16 000 (128 kbit/s).
6	Up to 32 000 (256 kbit/s).
7	Up to 64 000 (512 kbit/s).
8	Up to 128 000 (1024 kbit/s).
9	Up to 256 000 (2048 kbit/s).

<mean>^(num)

Mean throughput class(in octets per hour).

[0]	network subscribed value
1	100 (~0.22 bit/s)
2	200 (~0.44 bit/s)
3	500 (~1.11 bit/s)
4	1 000 (~2.2 bit/s)
5	2 000 (~4.4 bit/s)
6	5 000 (~11.1 bit/s)
7	10 000 (~22 bit/s)
8	20 000 (~44 bit/s)
9	50 000 (~111 bit/s)
10	100 000 (~0.22 kbit/s)
11	200 000(~0.44 kbit/s)
12	500 000(~1.11 kbit/s)
13	1 000 000 (~2.2 kbit/s)
14	2 000 000 (~4.4 kbit/s)
15	5 000 000 (~11.1 kbit/s)
16	10 000 000 (~22 kbit/s)
17	20 000 000 (~44 kbit/s)
18	50 000 000 (~111 kbit/s)
31	best effort

<PDP_type>^(str)

Packet Data Protocol Type

“IP“

Notes

- If parameters are not defined, the parameter default values depend on the HLR-stored subscribed default values.
- Definitions of parameters in GSM 02.60 and GSM 03.60 paragraph 15.2 "Quality of Service Profile".

Example

If some of the QoS parameters are omitted, they will keep their current value (or the default value if not specified so far), e.g.:

```
AT+CGDCONT=1, "IP"  
OK  
AT+CGQMIN=  
OK  
AT+CGQMIN?  
+CGQMIN:1,0,0,0,0,0  
OK  
AT+CGQMIN=1,0  
OK  
AT+CGQMIN?  
+CGQMIN:1,0,0,0,0,0  
OK  
AT+CGQMIN=1,0,0,0,1  
OK  
AT+CGQMIN?  
+CGQMIN:1,0,0,0,1,0  
OK  
AT+CGQMIN=1,1  
OK  
AT+CGQMIN?  
+CGQMIN:1,1,0,0,1,0  
OK
```

11.11 AT+CGQREQ Quality of Service Profile (Requested)

Syntax

<p>Test Command</p> <pre>AT+CGQREQ=?</pre> <p>Response(s)</p> <pre>+CGQREQ: <PDP_type>, (list of supported <precedence>s), (list of supported <delay>s), (list of supported <reliability>s), (list of supported <peak>s), (list of supported <mean>s) OK</pre>	
<p>Read Command</p> <pre>AT+CGQREQ?</pre> <p>Response(s)</p> <pre>[+CGQREQ: <cid>, <precedence>, <delay>, <reliability>, <peak>, <mean>] [+CGQREQ: ...]</pre>	
<p>Write Command</p> <pre>AT+CGQREQ=<cid>[, <precedence>[, <delay>[, <reliability>[, <peak>[, <mean>]]]]]</pre> <p>Response(s)</p> <pre>OK ERROR +CME ERROR</pre>	
<p>Reference(s)</p> <p>GSM 07.07</p>	

Command Description

The test command returns values supported as a compound value. If the MT supports several PDP types, the parameter value ranges for each PDP type are returned on a separate line.

The read command returns the current settings for each defined context.

This command allows the TE to specify a Quality of Service Profile that is used when the MT sends an Activate PDP Context Request message to the network.

The set command specifies a profile for the context identified by the (local) context identification parameter, **<cid>**.

A special form of the set command, **+CGQREQ=<cid>** causes the requested profile for context number **<cid>** to become undefined.

AT&F and **ATZ** will undefine the QoS profiles of every context which is not active or not online.

Parameter Description

<cid>^(num)

Parameter specifies a particular PDP context definition. The parameter is local to the TE-MT interface and is used in other PDP context-related commands.

1...2

<precedence>^(num)

Precedence class

[0]	network subscribed value
1	High Priority Service commitments shall be maintained ahead of precedence classes 2 and 3

- 2 Normal priority
Service commitments shall be maintained ahead of precedence class 3
- 3 Low priority
Service commitments shall be maintained

<delay>^(num)

Delay class

This parameter defines the end-to-end transfer delay incurred in the transmission of SDUs through the GPRS network(s).

- [0] network subscribed value
- 1..4 with SDU size = 128 octets:

Delay Class	Mean Transfer Delay	95 percentile
1 (Predictive)	<0.5	<1.5
2 (Predictive)	<5	<25
3 (Predictive)	<50	<250
4 (Best Effort)	Unspecified	-

with SDU size = 1024 octets:

Delay Class	Mean Transfer Delay	95 percentile
1 (Predictive)	<0.5	<1.5
2 (Predictive)	<5	<25
3 (Predictive)	<50	<250
4 (Best Effort)	Unspecified	-

<reliability>^(num)

Reliability class

- [0] network subscribed value
- 1 Non real-time traffic, error-sensitive application that cannot cope with data loss
- 2 Non real-time traffic, error-sensitive application that can cope with infrequent data loss
- 3 Non real-time traffic, error-sensitive application that can cope with data loss, GMM/SM, and SMS
- 4 Real-time traffic, error-sensitive application that can cope with data loss
- 5 Real-time traffic, error non-sensitive application that can cope with data loss

<peak>^(num)

Peak throughput class
in octets per second

- [0] network subscribed value
- 1 Up to 1 000 (8 kbit/s)
- 2 Up to 2 000 (16 kbit/s)
- 3 Up to 4 000 (32 kbit/s)
- 4 Up to 8 000 (64 kbit/s)
- 5 Up to 16 000 (128 kbit/s)

6	Up to 32 000 (256 kbit/s)
7	Up to 64 000 (512 kbit/s)
8	Up to 128 000 (1024 kbit/s)
9	Up to 256 000 (2048 kbit/s)

<mean>^(num)

Mean throughput class
in octets per hour

[0]	network subscribed value
1	100 (~0.22 bit/s)
2	200 (~0.44 bit/s)
3	500 (~1.11 bit/s)
4	1 000 (~2.2 bit/s)
5	2 000 (~4.4 bit/s)
6	5 000 (~11.1 bit/s)
7	10 000 (~22 bit/s)
8	20 000 (~44 bit/s)
9	50 000 (~111 bit/s)
10	100 000 (~0.22 kbit/s)
11	200 000(~0.44 kbit/s)
12	500 000(~1.11 kbit/s)
13	1 000 000 (~2.2 kbit/s)
14	2 000 000 (~4.4 kbit/s)
15	5 000 000 (~11.1 kbit/s)
16	10 000 000 (~22 kbit/s)
17	20 000 000 (~44 kbit/s)
18	50 000 000 (~111 kbit/s)
31	best effort

<PDP_type>^(str)

Packet Data Protocol type

"IP"

Notes

- If parameters are not defined, the parameter default values depend on the HLR-stored subscribed default values.
- Definitions of parameters in GSM 02.60 and GSM 03.60 paragraph 15.2 "Quality of Service Profile".

Example

If some of the QoS parameters are omitted, they will keep their current value (or the default value if not specified so far), e.g.:

```
AT+CGDCONT=1, "IP"
OK
AT+CGQREQ=
OK
```

```
AT+CGQREQ?  
+CGQREQ:1,0,0,0,0,0  
OK  
AT+CGQREQ=1,0  
OK  
AT+CGQMIN?  
+CGQREQ:1,0,0,0,0,0  
OK  
AT+CGQREQ=1,0,0,0,1  
OK  
AT+CGQREQ?  
+CGQREQ:1,0,0,0,1,0  
OK  
AT+CGQREQ=1,1  
OK  
AT+CGQREQ?  
+CGQREQ:1,1,0,0,1,0  
OK
```

11.12 AT+CGREG GPRS network registration status

The write command controls the presentation of an unsolicited result code "+CGREG: <stat>" when <n>=1 and there is a change in the MT's GPRS network registration status, or unsolicited result code "+CGREG: <stat>, <lac>, <ci>" when <n>=2 and there is a change of the network cell.

The read command returns the status of result code presentation and an integer <stat> which shows whether the network has currently indicated the registration of the MT. Location information elements <lac> and <ci> are returned only when <n>=2 and MT is registered in the network.

Syntax

<p>Test Command</p> <p>AT+CGREG=?</p> <p>Response(s)</p> <p>+CGREG: (list of supported <n>s)</p> <p>OK</p>	
<p>Read Command</p> <p>AT+CGREG?</p> <p>Response(s)</p> <p>+CGREG: <n>, <stat>[, <lac>, <ci>]</p> <p>OK</p>	
<p>Write Command</p> <p>AT+CGREG=[<n>]</p> <p>Response(s)</p> <p>OK</p> <p>ERROR</p> <p>+CME ERROR</p>	
<p>Reference(s)</p> <p>GSM 07.07</p>	

Unsolicited Result Codes

URC 1

+CGREG: <stat>

Indicates a change in the MT's GPRS network registration status.

URC 2

+CGREG: <stat>, <lac>, <ci>

Indicates a change in the MT's GPRS network registration status a change of the network cell including location information.

Parameter Description

<n> ^(num)	
0 ^(P)	Disable network registration unsolicited result code
1	Enable network registration unsolicited result code "+CGREG: <stat>"
2	Enable network registration unsolicited result code "+CGREG: <stat>, <lac>, <ci>"

`<stat>`^(num)

0	Not registered, ME is not currently searching an operator to register to. The ME is in GMM state GMM-NULL or GMM-DEREGISTERED-INITIATED. The GPRS service is disabled, the ME is allowed to attach to GPRS if requested by the user.
1	Registered, home network. The ME is in GMM state GMM-REGISTERED or GMM-ROUTING-AREA-UPDATING-INITIATED INITIATED on the home PLMN
2	Not registered, but ME is currently trying to attach or searching an operator to register to. The ME is in GMM state GMM-DEREGISTERED or GMM-REGISTERED-INITIATED. The GPRS service is enabled, but an allowable PLMN is currently not available. The ME will start a GPRS attach as soon as an allowable PLMN is available.
3	Registration denied. The ME is in GMM state GMM-NULL. The GPRS service is disabled, the ME is not allowed to attach to GPRS if requested by the user.
4	Unknown
5	Registered, roaming. The ME is in GMM state GMM-REGISTERED or GMM-ROUTING-AREA-UPDATING-INITIATED on a visited PLMN.

`<lac>`^(str)

Two byte location area code in hexadecimal format.

`<ci>`^(str)

Two byte cell ID in hexadecimal format.

Note

- When the module is GPRS attached and a PLMN reselection occurs to a non-GPRS network or to a network where the SIM is not subscribed to for using GPRS, the resulting GMM (GPRS mobility management) state according to GSM 24.008 is REGISTERED/NO CELL, meaning that the read command will still show `<stat>=1` or `<stat>=5`.

11.13 AT+CGSMS Select service for MO SMS messages

Syntax

<p>Test Command</p> <pre>AT+CGSMS=?</pre> <p>Response(s)</p> <pre>+CGSMS: (list of supported <service>s) OK</pre>	
<p>Read Command</p> <pre>AT+CGSMS?</pre> <p>Response(s)</p> <pre>+CGSMS: <service> OK</pre>	
<p>Write Command</p> <pre>AT+CGSMS=[<service>]</pre> <p>Response(s)</p> <pre>OK ERROR +CME ERROR</pre>	
<p>Reference(s)</p> <pre>GSM 07.07</pre>	

Command Description

The test command is used for requesting information on which services and service preferences can be set by using the [AT+CGSMS](#) write command

The read command returns the currently selected service or service preference.

The write command is used to specify the service or service preference that the MT will use to send MO SMS messages. If parameter [<service>](#) is not given, the current value remains unchanged.

Parameter Description

[<service>](#)^(num)

A numeric parameter which indicates the service or service preference to be used. Parameter is global for all interfaces and volatile.

0	GPRS
1	circuit switched
2	GPRS preferred (use circuit switched if mobile is not GPRS attached)
3(&F)(P)	circuit switched preferred (use GPRS if circuit switched is not available)

Note

- Sending SMS via GPRS is only possible when mobile is attached using [AT+CGATT](#)

11.14 AT^SGACT Query all PDP context activations

Syntax

<p>Test Command</p> <pre>AT^SGACT=?</pre> <p>Response(s)</p> <pre>^SGACT: (range of supported <ifc>s) , (range of supported <state>s) OK</pre>	
<p>Read Command</p> <pre>AT^SGACT?</pre> <p>Response(s)</p> <pre>[^SGACT: <ifc>, <cid>, <state>] [^SGACT: <ifc>, <cid>, <state>] [^SGACT: ...] OK</pre>	
<p>Exec Command</p> <pre>AT^SGACT</pre> <p>Response(s)</p> <pre>^SGACT: <sum> OK</pre>	
<p>Reference(s)</p> <p>SIEMENS</p>	

Command Description

The test command returns supported interfaces and states.

The read command lists the activation states for all activated PDP contexts of the ME. Contexts, which are created internally by the GPRS modem compatibility commands, will displayed only, if they are activated. The Output of this command is unsorted.

The exec command returns the sum of all activated PDP contexts of the ME.

Parameter Description

<ifc>^(num)

Interface

Specifies the interface on which a particular PDP context was defined. Every PDP context defined with the command [AT+CGDCONT](#) or internally by the GPRS modem compatibility commands is identified one-to-one by its (local) context identifier and the interface on which it was defined. The range of supported interfaces is returned by the test command.

0	ASC0 or Multiplex channel 1
1	ASC1 or Multiplex channel 2
2	Multiplex channel 3

<cid>^(num)

PDP context identifier

The interface local identifier which was used to define a PDP context using the command [AT+CGDCONT](#) or which was created internally by using the GPRS modem compatibility commands [ATD*98#](#) or [ATD*99#](#). The range of supported values is returned by the [AT+CGDCONT](#) test command. Values 3 and 4 will be used by the GPRS modem compatibility commands [ATD*98#](#) or [ATD*99#](#) if no context identifier was specified as the command was invoked.

<state>^(num)

PDP context activation state

Indicates the state of the PDP context activation.

0 deactivated

1 activated

<sum>^(num)

The sum of all activated PDP contexts of the ME.

11.15 AT^SGAUTH Set type of authentication for PPP connection

Syntax

<p>Test Command</p> <pre>AT^SGAUTH=?</pre> <p>Response(s)</p> <pre>^SGAUTH: (list of supported <auth>s) OK ERROR +CME ERROR</pre>	
<p>Read Command</p> <pre>AT^SGAUTH?</pre> <p>Response(s)</p> <pre>^SGAUTH: <auth> OK ERROR +CME ERROR</pre>	
<p>Write Command</p> <pre>AT^SGAUTH=<auth></pre> <p>Response(s)</p> <pre>OK ERROR +CME ERROR</pre>	
<p>Reference(s)</p> <p>SIEMENS</p>	<p>PIN ASC0 ASC1 USB MUX1 MUX2 MUX3 Charge → Last</p> <p><input type="radio"/> <input checked="" type="radio"/> <input checked="" type="radio"/> <input checked="" type="radio"/> <input checked="" type="radio"/> <input checked="" type="radio"/> <input checked="" type="radio"/> <input checked="" type="radio"/> <input type="radio"/> <input checked="" type="radio"/> <input type="radio"/></p>

Parameter Description

<auth>^(num)	
Indicates types of supported authentication.	
0	none
1	PAP
2	CHAP
3(&F)(P)	PAP and CHAP

11.16 AT^SGCONF Configuration of GPRS related Parameters

Syntax

<p>Test Command</p> <pre>AT^SGCONF=?</pre> <p>Response(s)</p> <pre>^SGCONF: (list of supported <llc_pdu_length_U>s), (list of supported <GPRS msclass>es) OK</pre>	
<p>Read Command</p> <pre>AT^SGCONF?</pre> <p>Response(s)</p> <pre>^SGCONF: <llc_pdu_length_U>, <GPRS msclass> OK</pre>	
<p>Write Command</p> <pre>AT^SGCONF=[<llc_pdu_length_U>][, <GPRS msclass>]</pre> <p>Response(s)</p> <pre>OK ERROR +CME ERROR</pre>	
<p>Reference(s)</p> <p>SIEMENS</p>	<p>PIN ASC0 ASC1 USB MUX1 MUX2 MUX3 Charge → Last</p> <p><input type="radio"/> <input checked="" type="radio"/> <input checked="" type="radio"/> <input checked="" type="radio"/> <input checked="" type="radio"/> <input checked="" type="radio"/> <input checked="" type="radio"/> <input checked="" type="radio"/> <input type="radio"/> <input checked="" type="radio"/> <input type="radio"/></p>

Parameter Description

<llc_pdu_length_U>^(num)

The maximum number of octets in an information field of Unnumbered (U) frames.

- | | |
|---------------------------|--|
| 0 | no negotiation with network (500 will be used) |
| 140...1520 ^(P) | lower values diminish performance |

<GPRS msclass>^(num)

GPRS Multislot Class. The parameter can be changed only when the MT is detached, otherwise "CME ERROR: operation temporary not allowed" will be returned. The value can be one of the classes indicated with the Test command. The value set is volatile and powerup value is the maximum allowed.

Notes

- +CME ERROR: invalid index: Parameter is out of range
- +CME ERROR: operation temporary not allowed: The command is blocked as long as GPRS is already in use (as long as mobile is GPRS attached).
- Writing to user profile with [AT&W](#) and restoring with [AT&F](#) are not supported.

11.17 ATA Manual response to a network request for PDP context activation

The V.250 [ATA](#) command may be used to accept a network request for a PDP context activation announced by the unsolicited result codes RING or "+CRING: GPRS". The MT responds with CONNECT, enters V.250 online data state and follows the same procedure as it would after having received a [AT+CGANS=1](#) with no <L2P> or <cid> values specified.

If you try to answer a request which is no longer present or which is already answered by another instance, NO CARRIER is returned.

Syntax

Exec Command	
ATA	
Response(s)	
CONNECT NO CARRIER	
Reference(s)	PIN ASC0 ASC1 USB MUX1 MUX2 MUX3 Charge → Last
GSM 07.07	● ● ● ● ● ● ○ ○ ●

11.18 ATD*99# Request GPRS service

This command causes the MT to perform whatever actions are necessary to establish communication between the TE and the external PDN.

The V.250 'D' (Dial) command causes the MT to enter the V.250 online data state and, with the TE, to start the specified layer 2 protocol. No further commands may follow on the AT command line. GPRS attachment and PDP context activation procedures may take place prior to or during the PDP startup if they have not already been performed using the [AT+CGATT](#) and [AT+CGACT](#) commands.

Examples on how to use this command are provided in chapter "[Using GPRS AT commands \(Examples\)](#)". To confirm acceptance of the command before entering the V.250 online data state command will respond with CONNECT.

When the layer 2 protocol has terminated, either as a result of an orderly shut down of the PDP or an error, the MT enters V.250 command state and returns NO CARRIER (for details refer to Section [11.5.1, Automatic deactivation of PDP context during dial-up PPP](#)).

Syntax

Exec Command	
ATD*99[* [<called_address>][* [<L2P>][* [<cid>]]]]#	
Response(s)	
CONNECT NO CARRIER	
Reference(s)	PIN ASC0 ASC1 USB MUX1 MUX2 MUX3 Charge → Last
GSM 07.07	● ● ● ● ● ● ○ ○ ●

Parameter Description

<called_address>^(str)

This parameter is currently not used and needs not to be specified.

<L2P>^(str)

Layer 2 protocol to be used between the TE and MT.

"PPP"	layer 2 protocol PPP
"1"	layer 2 protocol PPP

<cid>^(num)

Parameter specifies a particular PDP context definition (see [AT+CGDCONT](#) command). If no context is specified, an internal context with default properties is used (see [AT+CGDCONT](#), [AT+CGQREQ](#) and [AT+CGQMIN](#)).

1...2

Notes

- If TC65 is in dedicated mode, command returns "+CME ERROR: phone busy".
- [ATD](#) is used as a standard V.250 AT command, too.

11.19 ATD*98# Request GPRS IP service

This command causes the MT to perform whatever actions are necessary to establish a communication between the TE and the external PDN.

The V.250 'D' (Dial) command causes the MT to enter the V.250 online data state and, with the TE, to start the layer 2 protocol.

GPRS attachment and PDP context activation procedures may take place prior to or during the PDP startup if they have not already been performed using the [AT+CGATT](#) and [AT+CGACT](#) commands.

To confirm acceptance of the command before entering the V.250 online data state command will respond with CONNECT.

When the layer 2 protocol has terminated, either as a result of an orderly shut down of the PDP or an error, the MT enters V.250 command state and returns NO CARRIER (for details refer to Section [11.5.1, Automatic deactivation of PDP context during dial-up PPP](#)).

Syntax

Exec Command	
ATD*98[* <cid>]#	
Response(s)	
CONNECT	
NO CARRIER	
Reference(s)	
GSM 07.07	
	PIN ASC0 ASC1 USB MUX1 MUX2 MUX3 Charge → Last
	● ● ◐ ● ● ◐ ◐ ○ ○ ●

Parameter Description

<cid>^(num)

Parameter specifies a particular PDP context definition (see [AT+CGDCONT](#) command). If no context is specified, an internal context with default properties is used (see [AT+CGDCONT](#), [AT+CGQREQ](#) and [AT+CGQMIN](#)).

1...2

Notes

- If TC65 is in dedicated mode, command returns "+CME ERROR: phone busy".
- [ATD](#) is used as a standard V.250 AT command, too.

11.20 ATH Manual rejection of a network request for PDP context activation

The V.250 [ATH](#) command may be used to deactivate all PDP contexts which are active or online on the same interface. This command should not be used to deactivate PDP contexts during the implicit PDP context deactivation procedure which is started automatically after LCP termination or by dropping the DTR line (if [AT&D2](#) is configured). For details refer to Section [11.5.1, Automatic deactivation of PDP context during dial-up PPP](#). The [ATH](#) command may also be used to reject a network request for PDP context activation announced by the unsolicited result codes "RING" or "+[CRING](#): GPRS".

Syntax

Exec Command	
ATH	
Response(s)	
OK	
Reference(s)	PIN ASC0 ASC1 USB MUX1 MUX2 MUX3 Charge → Last
GSM 07.07	● ● ◐ ● ● ◐ ◐ ○ ○ ○

Notes

- In contrast to GSM 07.07 it is possible to cancel a connection with [ATH](#) after a break. This is done for compatibility reasons due to the "dial-up network" drivers of Microsoft Windows.
- [ATH](#) is used as a standard V.250 AT command, too.
- If [ATH](#) is used to reject a network request for PDP context activation, then other PDP contexts on the same interface which are active or online will not be deactivated.

11.21 ATSO Automatic response to a network request for PDP context activation

The V.250 `ATSO=<n>` (Automatic answer) command may be used to turn off ($n=0$) and on ($n>0$) the automatic response to a network request for a PDP context activation.

When the `ATSO=<n>` ($<n> > 0$) command is received, the MT will attempt to perform a GPRS attach if not yet attached and if configured to do so (see `AT^SCFG`, parameter `<gs0aa>`). Failure will result in ERROR being returned to the TE. Subsequently, the MT will announce a network request for PDP context activation by issuing the URC RING or CRING to the TE, followed by the intermediate result code CONNECT. The MT then enters V.250 online data state and follows the same procedure as it would after having received a `AT+CGANS=1` command with no `<L2P>` or `<cid>` values specified.

`ATSO=0` does not perform an automatic GPRS detach.

Syntax

Read Command	
ATSO?	
Response(s)	
<n>	
OK	
Write Command	
ATSO=<n>	
Response(s)	
OK	
Reference(s)	
GSM 07.07	



Parameter Description

<code><n></code> ^{(num)(&W)(&V)}	Description
000 ^(&F)	Disables automatic answer mode.
001-255	Enables automatic answering after specified number of rings.

Notes

- If different settings are used on each interface, and a request for PDP context activation is received, the interface 'wins' which is idle and uses the smallest `ATSO` value.
- If a network request for PDP context activation is answered automatically and another AT command is issued at the same time on the same interface then this AT command will not be executed. Any response belongs to the automatic context activation procedure. If the AT command which caused the collision was a CS data call, the CONNECT response does not belong to this data call but to the GPRS. This can be detected if `ATX` is not set to 0. CS data call will issue CONNECT `<text>`, GPRS will issue CONNECT only.
- A network request for PDP context activation has a maximum duration of approximately 40 seconds (for details see GSM 04.08). A RING/CRING URC is issued every 5 seconds, so setting parameter `<n>` to values greater than 7 will not allow a successful context activation and is not recommended.
- The automatic GPRS attach will not be performed on recalling a stored user profile with `ATZ` or on powerup, if a $n > 0$ setting was stored in the user profile with `AT&W`.
- If the automatic GPRS attach fails (e.g. the network rejects the attach request), the write command returns error, though the new value takes effect. This is necessary because `ATSO` is used for circuit switched calls too.
- `ATSO` write command is PIN protected.

11.22 Using GPRS AT commands (Examples)

Examples

EXAMPLE 1

Defining and using a Context Definition ID (CID):

Every time a CID is used as a parameter for a GPRS command the CID has to be defined before by using the [AT+CGDCONT](#) command. To get the parameter of a CID use the [AT+CGDCONT](#) read option. If the response of 'AT+CGDCONT?' is OK only, there is no CID defined.

```
AT+CGDCONT?  
OK                               There is no CID defined
```

All parameters of the CID are initiated by NULL or not present values, and the CID itself is set to be undefined. To define a CID use the [AT+CGDCONT](#) command with at least one CID parameter. At the moment the mobile supports CID 1 and CID 2 by using the [AT+CGDCONT](#) command.

Define CID 1 and set the PDP type to IP, access point name and IP address are not set:

```
AT+CGDCONT=1, "IP"  
OK
```

Define CID 2 and sets PDP type, APN and IP addr:

```
AT+CGDCONT=2, "IP", "internet.t-d1.gprs", 111.222.123.234  
OK
```

A following read command will respond:

```
AT+CGDCONT?  
+CGDCONT:1, "IP", "", "", 0, 0  
+CGDCONT:2, "IP", "internet.t-d1.gprs", 111.222.123.234  
OK
```

Set the CID 1 to be undefined:

```
AT+CGDCONT=1  
OK
```

A following read command will respond:

```
AT+CGDCONT?  
+CGDCONT:2, "IP", "internet.t-d1.gprs", 111.222.123.234  
OK
```

EXAMPLE 2

Quality of Service (QoS) is a special parameter of a CID which consists of several parameters itself.

The QoS consists of

- the precedence class
- the delay class
- the reliability class
- the peak throughput class
- the mean throughput class

and is divided in "requested QoS" and "minimum acceptable QoS".

All parameters of the QoS are initiated by default to the "network subscribed value (= 0)" but the QoS itself is set to be undefined. To define a QoS use the [AT+CGQREQ](#) or [AT+CGQMIN](#) command.

Overwrite the precedence class of QoS of CID 1 and set the QoS of CID 1 to be present:

```
AT+CGQREQ=1,2
OK
```

A following read command will respond:

```
AT+CGQREQ?
+CGQREQ: 1,2,0,0,0,0
OK
```

All QoS values of CID 1 are set to network subscribed now, except precedence class which is set to 2. Now set the QoS of CID 1 to not present:

```
AT+CGQREQ=1
OK
```

Once defined, the CID it can be activated. To activate CID 2 use:

```
AT+CGACT=1,2
OK
```

If the CID is already active, the mobile responds OK at once.

If no CID and no STATE is given, all defined CIDs will be activated by:

```
AT+CGACT=
OK
```

If no CID is defined the mobile responds +CME ERROR: invalid index

Remark: If the mobile is NOT attached by [AT+CGATT](#)=1 before activating, the attach is automatically done by the [AT+CGACT](#) command.

After defining and activating a CID it may be used to get online by:

```
AT+CGDATA="PPP",1
CONNECT
```

The mobile is connected using the parameters of CID 1.

```
AT+CGDATA=
CONNECT
```

The mobile is connected using default parameters (<L2P>="PPP" and <cid> as described for command [AT+CGDATA](#)).

The mobile supports Layer 2 Protocol (L2P) PPP only.

Remark: If the mobile is NOT attached by [AT+CGATT](#)=1 and the CID is NOT activated before connecting, attaching and activating is automatically done by the [AT+CGDATA](#) command.

Some providers (e.g. Vodafone or E-Plus) require to use an APN to establish a GPRS connection. So if you use the Microsoft Windows Dial-Up Network and ATD*9... to connect to GPRS you must provide the context definition as part of the modem definition (Modem properties/Connection/Advanced.../Extra settings). As an alternative, you can define and activate the context in a terminal program (e.g. Microsoft Hyperterminal) and then use the Dial-Up Network to send only the [ATD](#) command.

11.23 Using the GPRS dial command ATD

Example

In addition to the GPRS AT commands you can use the "D" command to dial into to the GPRS network.

There are two GPRS Service Codes for the ATD command: Values 98 and 99.

Examples:

ATD*99# CONNECT	Establish a connection by service code 99.
ATD*99*123.124.125.126*PPP*1# CONNECT	Establish a connection by service code 99, IP address 123 and L2P = PPP and using CID 1. The CID has to be defined by AT+CGDCONT .
ATD*99**PPP# CONNECT	Establish a connection by service code 99 and L2P = PPP.
ATD*99***1# CONNECT	Establish a connection by service code 99 and using CID 1.
ATD*99**PPP*1# CONNECT	Establish a connection by service code 99 and L2P = PPP and using CID 1. The CID has to be defined by AT+CGDCONT .
ATD*98# CONNECT	Establish a connection by service code 98.
ATD*98*1# CONNECT	Establish an IP connection by service code 98 using CID 1. The CID has to be defined by AT+CGDCONT .

12. FAX Commands

The following commands can be used for FAX transmission. If the ME is acting as a Fax modem for a PC based application (e.g. "WinFax") it is necessary to select the proper Service Class (Fax Class) provided by the ME. The ME reports its Service Class capabilities, both the current setting and the range of services available. This is provided by the [AT+FCLASS](#) command.

Service Classes supported by the ME:

AT+FCLASS Parameter	Service class	Reference, Standard
0	Data modem	e.g. TIA/EIA-602 or ITU V.250
1	Service Class 1	EIA/TIA-578-A

12.1 FAX parameters

Parameter Description

<mod>^(num)

Modulation mode

3	V21 Ch2 - 300 bps
24	V.27ter - 2400 bps
27	V.27ter - 4800 bps
48	V.27ter - 7200 bps
72	V.29 - 7200 bps
96	V.29 - 9600 bps

Note

- Only the default value needs to be implemented. Use the test commands to check which parameter values are really possible.

12.2 AT+FCLASS Fax: Select, read or test service class

[AT+FCLASS](#) sets the ME to a particular mode of operation (data, fax). This allows the ME to process information in a manner suitable for that type of information.

Syntax

<p>Test Command</p> <p>AT+FCLASS=?</p> <p>Response(s)</p> <p>(list of supported <n>s)</p> <p>OK</p>																					
<p>Read Command</p> <p>AT+FCLASS?</p> <p>Response(s)</p> <p><n></p> <p>OK</p>																					
<p>Write Command</p> <p>AT+FCLASS=<n></p> <p>Response(s)</p> <p>OK</p>																					
<p>Reference(s)</p> <p>EIA/TIA-592-A</p>	<table border="1"> <tr> <td>PIN</td> <td>ASC0</td> <td>ASC1</td> <td>USB</td> <td>MUX1</td> <td>MUX2</td> <td>MUX3</td> <td>Charge</td> <td>→</td> <td>Last</td> </tr> <tr> <td><input type="radio"/></td> <td><input checked="" type="radio"/></td> <td><input type="radio"/></td> <td><input checked="" type="radio"/></td> <td><input checked="" type="radio"/></td> <td><input type="radio"/></td> <td><input type="radio"/></td> <td><input type="radio"/></td> <td><input checked="" type="radio"/></td> <td><input type="radio"/></td> </tr> </table>	PIN	ASC0	ASC1	USB	MUX1	MUX2	MUX3	Charge	→	Last	<input type="radio"/>	<input checked="" type="radio"/>	<input type="radio"/>	<input checked="" type="radio"/>	<input checked="" type="radio"/>	<input type="radio"/>	<input type="radio"/>	<input type="radio"/>	<input checked="" type="radio"/>	<input type="radio"/>
PIN	ASC0	ASC1	USB	MUX1	MUX2	MUX3	Charge	→	Last												
<input type="radio"/>	<input checked="" type="radio"/>	<input type="radio"/>	<input checked="" type="radio"/>	<input checked="" type="radio"/>	<input type="radio"/>	<input type="radio"/>	<input type="radio"/>	<input checked="" type="radio"/>	<input type="radio"/>												

Parameter Description

<n> ^{(num)(&W)(&V)}	
[0] ^(&F)	Data (e.g. EIA/TIA-602 or ITU V.250)
1	Fax class 1 (EIA/TIA-578-A, Service Class 1)

Notes

- Using Error Correcting Mode (ECM) when sending FAXes over GSM should be avoided.
- If <n> is set to 1, all incoming calls will be answered as fax calls when [ATA](#) is issued on multiplexer channel 1 resp. ASC0. For calls explicitly signaled as voice or data calls, this procedure will fail with result code "NO CARRIER", but the incoming call will continue to ring.
It is possible to change the setting of <n> to 0 while the call is ringing, and accept the call afterwards with [ATA](#).

12.3 AT+FRH Receive Data Using HDLC Framing

The [AT+FRH](#) command enables the TA to receive frames using the HDLC protocol and the modulation defined in Section 12.1, [FAX parameters](#). An ERROR response code results if this command is issued while the modem is on-hook.

Syntax

Write Command									
AT+FRH=<mod>									
Response(s)									
CONNECT									
If error related to ME functionality									
ERROR									
Reference(s)									
TIA/EIA-578									
PIN	ASC0	ASC1	USB	MUX1	MUX2	MUX3	Charge	↗	Last
<input type="radio"/>	<input checked="" type="radio"/>	<input type="radio"/>	<input checked="" type="radio"/>	<input checked="" type="radio"/>	<input type="radio"/>	<input type="radio"/>	<input type="radio"/>	<input type="radio"/>	<input type="radio"/>

Note

- Used for Fax Class 1 only

12.4 AT+FRM Receive Data

The **AT+FRM** command causes the TA to enter the receive mode using the modulation defined in Section 12.1, **FAX parameters**. An ERROR response code results if this command is issued while the modem is on-hook.

Syntax

Test Command	
AT+FRM=?	
Response(s)	
(list of <mod>s)	
OK	
Write Command	
AT+FRM=<mod>	
Response(s)	
CONNECT	
If error is related to ME functionality:	
ERROR	
Reference(s)	
TIA/EIA-578	
	PIN ASC0 ASC1 USB MUX1 MUX2 MUX3 Charge ↗ Last
	<input type="radio"/> <input checked="" type="radio"/> <input type="radio"/> <input checked="" type="radio"/> <input checked="" type="radio"/> <input type="radio"/> <input type="radio"/> <input type="radio"/> <input type="radio"/> <input type="radio"/>

Notes

- Used for Fax Class 1 only
- <mod>= 3 is not possible

12.5 AT+FRS Receive Silence

<time>=n causes the TA to report an OK result code to the TE after <time> 10 millisecond intervals of silence have been detected on the line.

The command is aborted if any character is received by the DTE. The modem discards the aborting character and issues an OK result code. An ERROR response code results if this command is issued while the mode is on-hook.

Syntax

Write Command	
AT+FRS=<time>	
Response(s)	
OK	
If error related to ME functionality	
ERROR	
Reference(s)	PIN ASC0 ASC1 USB MUX1 MUX2 MUX3 Charge → Last
TIA/EIA-578	<input type="radio"/> <input checked="" type="radio"/> <input type="radio"/> <input checked="" type="radio"/> <input checked="" type="radio"/> <input type="radio"/> <input type="radio"/> <input type="radio"/> <input type="radio"/> <input type="radio"/>

Parameter Description

<time> ^(num)
Number of 10 millisecond intervals
0...255

Note

- Used for Fax Class 1 only

12.6 AT+FTH Transmit Data Using HDLC Framing

The [AT+FTH](#) command causes the TA to transmit data using HDLC protocol and the modulation mode defined in Section 12.1, [FAX parameters](#). An ERROR response code results if this command is issued while the modem is on-hook.

Syntax

Write Command	
AT+FTH=<mod>	
Response(s)	
CONNECT	
Reference(s)	PIN ASC0 ASC1 USB MUX1 MUX2 MUX3 Charge → Last
TIA/EIA-578	<input type="radio"/> <input checked="" type="radio"/> <input type="radio"/> <input checked="" type="radio"/> <input checked="" type="radio"/> <input type="radio"/> <input type="radio"/> <input type="radio"/> <input type="radio"/> <input type="radio"/>

Notes

- Used for Fax Class 1 only
- Only <mod>= 3 is possible

12.7 AT+FTM Transmit Data

The **AT+FTM** command causes the TA to transmit data using the modulation mode defined in Section 12.1, **FAX parameters**. An ERROR response code results if this command is issued while the modem is on-hook.

Syntax

<p>Test Command</p> <p>AT+FTM=?</p> <p>Response(s)</p> <p>(list of <mod>s)</p> <p>OK</p>	<p>Write Command</p> <p>AT+FTM=<mod></p> <p>Response(s)</p> <p>CONNECT</p> <p>If error is related to ME functionality</p> <p>ERROR</p>																				
<p>Reference(s)</p> <p>TIA/EIA-578</p>	<table border="1"> <thead> <tr> <th>PIN</th> <th>ASC0</th> <th>ASC1</th> <th>USB</th> <th>MUX1</th> <th>MUX2</th> <th>MUX3</th> <th>Charge</th> <th>✈</th> <th>Last</th> </tr> </thead> <tbody> <tr> <td><input type="radio"/></td> <td><input checked="" type="radio"/></td> <td><input type="radio"/></td> <td><input checked="" type="radio"/></td> <td><input checked="" type="radio"/></td> <td><input type="radio"/></td> <td><input type="radio"/></td> <td><input type="radio"/></td> <td><input type="radio"/></td> <td><input type="radio"/></td> </tr> </tbody> </table>	PIN	ASC0	ASC1	USB	MUX1	MUX2	MUX3	Charge	✈	Last	<input type="radio"/>	<input checked="" type="radio"/>	<input type="radio"/>	<input checked="" type="radio"/>	<input checked="" type="radio"/>	<input type="radio"/>	<input type="radio"/>	<input type="radio"/>	<input type="radio"/>	<input type="radio"/>
PIN	ASC0	ASC1	USB	MUX1	MUX2	MUX3	Charge	✈	Last												
<input type="radio"/>	<input checked="" type="radio"/>	<input type="radio"/>	<input checked="" type="radio"/>	<input checked="" type="radio"/>	<input type="radio"/>	<input type="radio"/>	<input type="radio"/>	<input type="radio"/>	<input type="radio"/>												

Notes

- Used for Fax Class 1 only
- <mod>= 3 is not possible

12.8 AT+FTS Stop Transmission and Wait

Syntax

Write Command	
AT+FTS=<time>	
Response(s)	
An ERROR response code results if this command is issued while the modem is on-hook.	
Reference(s)	
TIA/EIA-578	
	PIN ASC0 ASC1 USB MUX1 MUX2 MUX3 Charge → Last
	<input type="radio"/> <input checked="" type="radio"/> <input type="radio"/> <input checked="" type="radio"/> <input checked="" type="radio"/> <input type="radio"/> <input type="radio"/> <input type="radio"/> <input type="radio"/> <input type="radio"/>

Command Description

This command causes the TA to terminate a transmission and wait for <time> 10 millisecond intervals before responding with the OK result code to the DTE.

Parameter Description

<time> ^(num)
no. of 10 millisecond intervals
0...85

Note

- Used for Fax Class 1 only

13. Short Message Service (SMS) Commands

The AT Commands described in this chapter allow an external application to use the Short Message Service with the TC65.

13.1 SMS parameters

Parameter Description

`<ackpdu>`^(num)

Format is same for `<pdu>` in case of SMS, but without GSM 24.11 SC address field and parameter shall be bounded by double quote characters like a normal string type parameter

`<alpha>`^{(str)(+CSCS)}

String type alphanumeric representation of `<da>` or `<oa>` corresponding to the entry found in phonebook; implementation of this feature is manufacturer specific

`<cdata>`^(num)

Command Data

GSM 03.40 TP-Command-Data in text mode responses; ME/TA converts each 8-bit octet into two IRA character long hexadecimal numbers (e.g. octet with integer value 42 is presented to TE as two characters 2A (IRA 50 and 65))

`<ct>`^(num)

Command Type

GSM 03.40 TP-Command-Type in integer format

[0]...255

`<da>`^{(num)(+CSCS)}

Destination Address

GSM 03.40 TP- Destination-Address Address-Value field in string format; BCD numbers (or GSM default alpha-numeric characters) are converted into characters; type of address given by `<toda>`

`<data>`^{(num)(+CSCS)}

User Data

In case of SMS: GSM 03.40 TP-User-Data in text mode responses; format:

- If `<dc>` indicates that GSM 03.38 default alphabet is used and `<fo>` indicates that GSM 03.40 TP-User-Data-Header-Indication is not set: ME/TA converts GSM alphabet into current TE character set according to rules covered in Annex A.
- If `<dc>` indicates that 8-bit or UCS2 data coding scheme is used, or `<fo>` indicates that GSM 03.40 TP-User-Data-Header-Indication is set: ME/TA converts each 8-bit octet into hexadecimal numbers containing two IRA characters (e.g. octet with integer value 42 is presented to TE as two characters 2A (IRA 50 and 65)).

In case of CBS: GSM 03.41 CBM Content of Message in text mode responses; format:

- If `<dc>` indicates that GSM 03.38 default alphabet is used: ME/TA converts GSM alphabet into current TE character set according to rules covered in Annex A.
- If `<dc>` indicates that 8-bit or UCS2 data coding scheme is used: ME/TA converts each 8-bit octet into hexadecimal numbers containing two IRA characters.

<dt>^(num)

Discharge Time

GSM 03.40 TP-Discharge-Time in time-string format: "yy/MM/dd,hh:mm:ss+zz", where characters indicate year (two last digits), month, day, hour, minutes, seconds and time zone. For example, 6th of May 1994, 22:10:00 GMT+2 hours equals "94/05/06,22:10:00+08"

<ieia>^(num)

IEIa (Information Element Identifier octet) of the concatenated SMS.

8	Concatenated short messages, 8-bit reference number
16	Concatenated short messages, 16-bit reference number

<index>^(num)

Integer type; value in the range of location numbers supported by the associated memory

<length>^(num)

Message Length

Integer type value indicating in the text mode ([AT+CMGF=1](#)) the length of the message body [<data>](#) (or [<cdata>](#)) in characters; or in PDU mode ([AT+CMGF=0](#)), the length of the actual TP data unit in octets (i.e. the RP layer SMSC address octets are not counted in the length) In text mode, the maximum length of an SMS depends on the used coding scheme: It is 160 characters if the 7 bit GSM coding scheme is used, and 140 characters according to the 8 bit GSM coding scheme.

If the SMS message format is "text mode" ([AT+CMGF=1](#)) and the character set is set to "UCS2" with [AT+CSCS](#) and the SMS is also coded as "UCS2" (see [<dcs>](#) of [AT+CSMP](#)), then the length is in octets instead of characters.

For concatenated SMS messages the maximum length will be reduced by the length of the user data header with respect to [<ieia>](#) (6 bytes for [<ieia>](#)=8 and 7 bytes for [<ieia>](#)=16). In the case of 8-bit data, the maximum length of the short message field is: 140 octets - (6 or 7) = 134 or 133. In the case of GSM 7 bit default alphabet data, the maximum length of the short message is $(140 - (6 \text{ or } 7)) * 8/7 = 153 \text{ or } 152$ characters. In the case of 16 bit UC2 data, the maximum length of the short message is: $(140 - (6 \text{ or } 7))/2 = 67 \text{ or } 66$ characters.

<max>^(num)

Maximum number of all segments to be concatenated into one SMS, beginning with 1.
[<max>](#)=0 means: ignore the value. This will result in a non-concatenated SMS.

0...255

<mem1>^(str)

Memory to be used when listing, reading and deleting messages:

"SM"	SIM message storage
"ME"	Mobile Equipment message storage
"MT" ^(D)	Sum of "SM" and "ME" storages

<mem2>^(str)

Memory to be used when writing and sending messages:

"SM"	SIM message storage
"ME"	Mobile Equipment message storage
"MT" ^(D)	Sum of "SM" and "ME" storages

<mem3>^(str)

Received messages will be placed in this memory storage if routing to TE is not set. See command [AT+CNMI](#) with parameter <mt>=2.

"SM"	SIM message storage
"MT" ^(D)	Sum of "SM" and "ME" storages

<mid>^(num)

Message Identifier
GSM 03.41 CBM Message Identifier in integer format

<mn>^(num)

Message Number
GSM 03.40 TP-Message-Number in integer format

<mr>^(num)

Message Reference
GSM 03.40 TP-Message-Reference in integer format

<oa>^{(num)(+CSCS)}

Originating Address
GSM 03.40 TP-Originating-Address Address-Value field in string format; BCD numbers (or GSM default alphabet characters) are converted into characters; type of address given by <toa>

<page>^(num)

Page Parameter
GSM 03.41 CBM Page Parameter bits 4-7 in integer format

<pages>^(num)

Page Parameter
GSM 03.41 CBM Page Parameter bits 0-3 in integer format

<pdu>^(num)

In the case of SMS: GSM 04.11 SC address followed by GSM 03.40 TPDU in hexadecimal format: ME/TA converts each octet of TP data unit into hexadecimal numbers containing two IRA characters (e.g. octet with integer value 42 is presented to TE as two characters 2A (IRA 50 and 65)). In the case of CBS: <ra> GSM 03.40 TP-Recipient-Address Address-Value field in string format; BCD numbers (or GSM default alphabet characters) are converted into characters; type of address given by <tora>

<ra>^{(num)(+CSCS)}

Recipient Address
GSM 03.40 TP-Recipient-Address Address-Value field in string format; BCD numbers (or GSM default alphabet characters) are converted to characters of the currently selected TE character set (refer to command [AT+CSCS](#)); type of address given by <tora>

`<ref>`^(num)

Reference number to identify all segments of the concatenated SMS (i.e. the number needs to be the same for each segment). If `<ieia>=8` then max=255, otherwise 65535.

0...255

0...65535

`<sca>`^{(num)(+CSCS)}

Service Center Address

GSM 04.11 RP SC address Address-Value field in string format; BCD numbers (or GSM default alphabet characters) are converted to characters of the currently selected TE character set (refer to command `AT+CSCS`); type of address given by `<tosca>`

`<scts>`^(num)

Service Centre Time Stamp

GSM 03.40 TP-Service-Centre-Time-Stamp in time-string format (refer `<dt>`)

`<seq>`^(num)

Sequence number of the concatenated SMS beginning with 1. The number must be incremented by one for each segment of the concatenated short message.

`<seq>=0` means: ignore the value. This will result in a non-concatenated SMS.

0...255

`<sn>`^(num)

Serial Number

GSM 03.41 CBM Serial Number in integer format

`<st>`^(num)

Status

GSM 03.40 TP-Status in integer format

0...255

`<stat>`^(str)

Message status

3GPP 27.005 Interface of SMS and CB. Indicates the status of message in memory.

Description	text mode (<code><mode>=1</code>)	PDU mode (<code><mode>=0</code>)	Default
Received unread messages	"REC UNREAD"	0	for SMS reading commands
Received read messages	"REC READ"	1	
Stored unsent messages	"STO UNSENT"	2	for SMS writing commands
Stored sent messages	"STO SENT"	3	
All messages	"ALL"	4	

<todo>^(num)

Type of Destination Address

GSM 04.11 TP-Destination-Address Type-of-Address octet in integer format (when first character of <da> is + (IRA 43) default is 145, otherwise default is 129)

0...255

<tooa>^(num)

Type of Originating Address

GSM 04.11 TP-Originating-Address Type-of-Address octet in integer format (default refer <todo>)

<tora>^(num)

Type of Recipient Address

GSM 04.11 TP-Recipient-Address Type-of-Address octet in integer format (default refer <todo>)

<tosca>^(num)

Type of Service Center Address

GSM 04.11 RP SC address Type-of-Address octet in integer format (default refer <todo>)

13.2 AT+CMGC Send an SMS command

Syntax

<p>Test Command</p> <pre>AT+CMGC=?</pre> <p>Response(s)</p> <pre>OK</pre>	
<p>Write Command</p> <p>If text mode (see AT+CMGF=1)</p> <pre>AT+CMGC=<fo>, <ct>[, <pid>[, <mn>[, <da>[, <toda>]]]]<CR> Text can be entered <CTRL-Z>/<ESC></pre> <p>Response(s)</p> <pre>+CMGC: <mr>[, <scts>]</pre> <p>If sending fails</p> <pre>ERROR</pre> <pre>+CMS ERROR</pre>	
<p>Write Command</p> <p>If PDU mode (see AT+CMGF=0)</p> <pre>AT+CMGC=<length><CR> PDU can be entered <CTRL-Z>/<ESC></pre> <p>Response(s)</p> <pre>+CMGC: <mr>[, <ackpdu>]</pre> <pre>OK</pre> <p>If sending fails</p> <pre>ERROR</pre> <pre>+CMS ERROR</pre>	
<p>Reference(s)</p> <pre>GSM 07.05</pre>	

Notes

- After invoking the commands [AT+CMGW](#), [AT+CMGS](#) or [AT+CMGC](#) it is necessary to wait for the prompt ">" before entering text or PDU. After the prompt a timer will be started to observe the input.
- At baudrates below 19200 it is recommended to use the line termination character only (refer to [ATS3](#), default <CR>) before entering the text or PDU. Use of the line termination character followed by the response formatting character (refer to [ATS4](#), default <LF>) can cause problems

13.3 AT+CMGD Delete SMS message

Syntax

Test Command	
AT+CMGD=?	
Response(s)	
OK	
Write Command	
AT+CMGD=<index>	
Response(s)	
OK	
ERROR	
+CMS ERROR	
Reference(s)	
GSM 07.05	
	PIN ASC0 ASC1 USB MUX1 MUX2 MUX3 Charge → Last
	● ● ● ● ● ● ● ○ ● ○

Command Description

Write command deletes message from preferred message storage <mem1> location <index>.

Notes

- If there is no SMS stored at the selected index, the response is OK too.
- This command should be used only after the SMS data from the SIM have been read successfully for the first time. This may take up to 30 seconds after ^SYSSTART depending on the SIM used. A SMS delete attempt before the SIM is ready will result in "+CME Error: 14" (SIM busy).
- We recommend to take advantage of the "^SSIM READY" URC. If enabled with AT^SSET, this URC acknowledges to the user that SIM data is accessible after SIM PIN authentication. It will be delivered once the ME has completed reading data from the SIM card.

13.4 AT+CMGF Select SMS message format

Syntax

<p>Test Command</p> <p>AT+CMGF=?</p> <p>Response(s)</p> <p>+CMGF: (list of supported<mode>s)</p> <p>OK</p>	
<p>Read Command</p> <p>AT+CMGF?</p> <p>Response(s)</p> <p>+CMGF: <mode></p> <p>OK</p>	
<p>Write Command</p> <p>AT+CMGF=<mode></p> <p>Response(s)</p> <p>OK</p>	
<p>Reference(s)</p> <p>GSM 07.05</p>	<p>PIN ASC0 ASC1 USB MUX1 MUX2 MUX3 Charge ↗ Last</p> <p><input type="radio"/> <input checked="" type="radio"/> <input checked="" type="radio"/> <input checked="" type="radio"/> <input checked="" type="radio"/> <input checked="" type="radio"/> <input checked="" type="radio"/> <input checked="" type="radio"/> <input type="radio"/> <input checked="" type="radio"/> <input type="radio"/></p>

Command Description

The write command specifies the input and output format of the short messages.

Parameter Description

<mode> ^{(num)(&W)(&V)}	
[0] ^(&F)	PDU mode
1	Text mode

13.5 AT+CMGL List SMS messages from preferred store

Syntax

<p>Test Command</p> <p>AT+CMGL=?</p> <p>Response(s)</p> <p>+CMGL: (list of supported <stat>s)</p> <p>OK</p>	
<p>Exec Command</p> <p>AT+CMGL</p> <p>Response(s)</p> <p>+CMGL: (see write command for default of <stat>)</p> <p>OK</p>	
<p>Write Command</p> <p>AT+CMGL=<stat></p> <p>Response(s)</p> <p>Output if text mode (AT+CMGF=1) and command successful: For SMS- SUBMITs and/or SMS-DELIVERs</p> <p>+CMGL: <index>, <stat>, <oa>/<da>, [<alpha>], [<scts>][, <toa>/<toda>, <length>] <data> [...] OK</p> <p>For SMS-STATUS-REPORTs</p> <p>+CMGL: <index>, <stat>, <fo>, <mr>, [<ra>], [<tora>], <scts>, <dt>, <st> [...] OK</p> <p>For SMS-Commands</p> <p>+CMGL: <index>, <stat>, <fo>, <ct> [...] OK</p> <p>Output if PDU mode AT+CMGF=0 and command successful: For SMS-SUBMITs and/or SMS-DELIVERs</p> <p>+CMGL: <index>, <stat>, [<alpha>], <length> <pdu> [...] OK</p> <p>If error is related to ME functionality</p> <p>ERROR +CMS ERROR</p>	
<p>Reference(s)</p> <p>GSM 07.05</p>	<p>PIN ASC0 ASC1 USB MUX1 MUX2 MUX3 Charge → Last</p> <p>● ● ● ● ● ● ● ○ ● ○</p>

Command Description

The execute command is the same as the write command with the given default for <stat>.

The write command returns messages with status value <stat> from message storage <mem1> to the TE. If status of the message is 'received unread', status in the storage changes to 'received read'.

Notes

- The selected <mem1> can contain different types of SMS (e.g. SMS-DELIVERs, SMS-SUBMITs, SMS-STATUS-REPORTs and SMS-COMMANDs), the response may be a mix of the responses of different SM types. TE application can recognize the response format by examining the third response parameter.
- The parameters <ra> and <tora> will only be displayed if parameter <ra> of the AT^SSCONF command is set to 1.
- This command can be used only after the SMS data from the SIM have been read successfully for the first time. Reading starts after successful SIM authentication has been performed, and may take up to 30 seconds depending on the SIM used. While the read process is in progress, an attempt to use any of the SMS read commands will result in "+CME Error: 14" (SIM busy)
- We recommend to take advantage of the "^SSIM READY" URC. If enabled with AT^SSET, this URC acknowledges to the user that SIM data is accessible after SIM PIN authentication. It will be delivered once the ME has completed reading data from the SIM card.
- If the ME is Java controlled, take into account that the AT Command API can handle responses up to a length of 1024 bytes. To avoid any longer responses it is recommended not to read the entire range of phonebook entries at a time.

13.6 AT+CMGR Read SMS messages

Syntax

<p>Test Command</p> <pre>AT+CMGR=?</pre> <p>Response(s)</p> <pre>OK</pre>	<p>Write Command</p> <pre>AT+CMGR=<index></pre> <p>Response(s)</p> <p>Output if text mode (AT+CMGF=1) and command successful:</p> <p>For SMS-DELIVER</p> <pre>+CMGR: <stat>, <oa>, [<alpha>], <scts>[, <toa>, <fo>, <pid>, <dcsc>, <sca>, <tosca>, <length>] <data> [...] OK</pre> <p>For SMS-SUBMIT</p> <pre>+CMGR: <stat>, <da>, [<alpha>][, <toda>, <fo>, <pid>, <dcsc>, [<vp>], <sca>, <tosca>, <length>] <data> [...] OK</pre> <p>For SMS-STATUS-REPORT</p> <pre>+CMGR: <stat>, <fo>, <mr>, [<ra>], [<tora>], <scts>, <dt>, <st> <data> [...] OK</pre> <p>For SMS-Commands</p> <pre>+CMGR: <stat>, <fo>, <ct>[, <pid>, [<mn>], [<da>], [<toda>], <length>] <data> [...] OK</pre> <p>Output if PDU mode (AT+CMGF=0) and command successful:</p> <p>For SMS-SUBMITs and/or SMS-DELIVERs</p> <pre>+CMGR: <stat>, [<alpha>], <length> <pdu> [...] OK ERROR +CMS ERROR</pre>
<p>Reference(s)</p> <pre>GSM 07.05</pre>	<p>PIN ASC0 ASC1 USB MUX1 MUX2 MUX3 Charge Last</p>

Command Description

The write command returns SMS message with location value `<index>` from message storage `<mem1>` to the TE. If status of the message is 'received unread', status in the storage changes to 'received read'.

Notes

- Response if `AT+CMGR` is used to read an empty record index: `+CMGR: 0,,0`
- Response if `AT+CMGR` is used to read a non-existent record index: `+CMS ERROR: invalid memory index`
- The parameters `<ra>` and `<torra>` will only be displayed if parameter `<ra>` of the `AT^SSCONF` command is set to 1.
- This command can be used only after the SMS data from the SIM have been read successfully for the first time. Reading starts after successful SIM authentication has been performed, and may take up to 30 seconds depending on the SIM used. While the read process is in progress, an attempt to use any of the SMS read commands will result in "+CME Error: 14" (SIM busy)
- We recommend to take advantage of the "^SSIM READY" URC. If enabled with `AT^SSET`, this URC acknowledges to the user that SIM data is accessible after SIM PIN authentication. It will be delivered once the ME has completed reading data from the SIM card.

13.7 AT+CMGS Send SMS message

Syntax

<p>Test Command</p> <p>AT+CMGS=?</p> <p>Response(s)</p> <p>OK</p>	
<p>Write Command</p> <p>If text mode (see AT+CMGF=1)</p> <p>AT+CMGS=<da>[, <today>]<CR> Text can be entered. <CTRL-Z>/<ESC></p> <p>Response(s)</p> <p>+CMGS: <mr>[, <scts>]</p> <p>OK</p> <p>If sending fails see notes below.</p>	
<p>Write Command</p> <p>If PDU mode (see AT+CMGF=0)</p> <p>AT+CMGS=<length><CR> PDU can be entered. <CTRL-Z>/<ESC></p> <p>Response(s)</p> <p>+CMGS: <mr>[, <ackpdu>]</p> <p>OK</p> <p>If sending fails see notes below.</p>	
<p>Reference(s)</p> <p>GSM 07.05</p>	

Command Description

The write command transmits a short message from TE to network (SMS-SUBMIT). After invoking the write command wait for the prompt ">" and then start to write the message. To send the message simply enter <CTRL-Z>. After the prompt a timer will be started to observe the input. To abort sending use <ESC>. Abortion is acknowledged with "OK", though the message will not be sent. The message reference <mr> is returned to the TE on successful message delivery. The value can be used to identify the message in a delivery status report provided as an unsolicited result code.

Notes

- If sending fails, for example, if a message is too long, the result code depends on the current setting of the [AT^SM20](#) command:
If the [AT^SM20 <CmgwMode>](#) equals 1 (factory default) any failure to send a message is responded with "OK". Users should be aware, that despite the "OK" response, the message will not be sent to the subscriber.
If the [AT^SM20 <CmgwMode>](#) equals 0 any failure to send a message is responded with "ERROR".
- If sending fails due to timeout, then
[AT^SM20 <CmgwMode>=1](#) causes "+CMS ERROR: Unknown error" to be returned;
[AT^SM20 <CmgwMode>=0](#) causes "+CMS ERROR: timer expired" to be returned.
- Note that some providers do not recognize an @ symbol used in a short message. A widely used alternative is typing "*" as defined in GSM 03.40 (GPP TS 23.40).
- All characters entered behind the prompt ">" will be recognized as GSM characters. For example, "Backspace" (ASCII character 8) does not delete a character, but will be inserted into the short message as an additional physical character. As a result, the character you wanted to delete still appears in the text, plus the GSM code equivalent of the Backspace key.
- In text mode, the maximum length of an SMS depends on the used coding scheme: It is 160 characters if the 7 bit GSM coding scheme is used, and 140 characters according to the 8 bit GSM coding scheme.

- At baudrates lower than 19200 it is recommended to use the line termination character only (refer to [<n>](#) of [ATS3](#), default `<CR>`) before entering text or PDU. Use of the line termination character followed by the response formatting character (see [<n>](#) of [ATS4](#), default `<LF>`) can cause problems.

13.8 AT+CMGW Write SMS messages to memory

Syntax

<p>Test Command</p> <p>AT+CMGW=?</p> <p>Response(s)</p> <p>OK</p>	
<p>Exec Command</p> <p>If text mode (see AT+CMGF=1):</p> <p>AT+CMGW</p> <p>Response(s)</p> <p><CR> Text can be entered. <CTRL-Z>/<ESC></p> <p>+CMGW: <index></p> <p>OK</p> <p>If writing fails</p> <p>ERROR</p> <p>+CMS ERROR</p>	
<p>Write Command</p> <p>If text mode (see AT+CMGF=1):</p> <p>AT+CMGW=<oa>/<da>[, [<tooa>/<toda>]], <stat>]<CR> Text can be entered. <CTRL-Z>/<ESC></p> <p>Response(s)</p> <p>+CMGW: <index></p> <p>OK</p> <p>If writing fails see notes below.</p>	
<p>Write Command</p> <p>If PDU mode (see AT+CMGF=0):</p> <p>AT+CMGW=<length>[, <stat>]<CR> PDU can be entered. <CTRL-Z>/<ESC></p> <p>Response(s)</p> <p>+CMGW: <index></p> <p>OK</p> <p>If writing fails see notes below.</p>	
<p>Reference(s)</p> <p>GSM 07.05</p>	<p>PIN ASC0 ASC1 USB MUX1 MUX2 MUX3 Charge → Last</p> <p>● ● ● ● ● ● ● ○ ● ○</p>

Command Description

The execute and write commands transmit SMS (either SMS-DELIVER or SMS-SUBMIT) from TE to memory storage <mem2>. Memory location <index> of the stored message is returned. Message status will be set to 'stored unsent' unless otherwise given in parameter <stat>.

After invoking the execute or write command wait for the prompt ">" and then start to write the message. To save the message simply enter <CTRL-Z>. After the prompt a timer will be started to observe the input.

To abort writing use <ESC>. Abortion is acknowledged with "OK", though the message will not be saved.

Notes

- If writing fails, for example, if a message is too long, the result code depends on the current setting of the [AT^SM20](#) command:
 - If the [AT^SM20 <CmgwMode>=1](#) (factory default) any failure to send a message is responded with "OK". Users should be aware, that despite the "OK" response, the message will not be written to the selected SMS storage.
 - If the [AT^SM20 <CmgwMode>](#) equals 0 any failure to write a message is responded with "ERROR".

- If writing fails due to timeout, then
`AT^SM20 <CmgwMode>=1` causes "+CMS ERROR: Unknown error" to be returned;
`AT^SM20 <CmgwMode>=0` causes "+CMS ERROR: timer expired" to be returned.
- Note that some providers do not recognize an @ symbol used in a short message. A widely used alternative is typing "*" as defined in GSM 03.40 (GPP TS 23.40).
- For baudrates lower than 19200 it is recommended to use the line termination character only (refer to `ATS3=<n>`, default `<CR>`) before entering the text or PDU. Use of the line termination character followed by the response formatting character (see `ATS4=<n>`, default `<LF>`) may cause problems.
- SMS-COMMANDs and SMS-STATUS-REPORTs cannot be stored in text mode.
- All characters entered behind the ">" prompt will be recognized as GSM characters. For example, "Backspace" (ASCII character 8) does not delete a character, but will be inserted into the short message as an additional physical character. As a result, the character you wanted to delete still appears in the text, plus the GSM code equivalent of the Backspace key.
- In text mode, the maximum length of an SMS depends on the used coding scheme: It is 160 characters if the 7 bit GSM coding scheme is used, and 140 characters according to the 8 bit GSM coding scheme.
- The length of 8-bit data coded short messages has to be greater than 0.

13.9 AT+CMSS Send SMS messages from storage

Syntax

<p>Test Command</p> <p>AT+CMSS=?</p> <p>Response(s)</p> <p>OK</p>	
<p>Write Command</p> <p>If text mode (AT+CMGF=1):</p> <p>AT+CMSS=<index>[, <da>[, <toda>]]</p> <p>Response(s)</p> <p>+CMSS: <mr>[, <scts>]</p> <p>OK</p> <p>If sending fails</p> <p>ERROR</p> <p>+CMS ERROR</p>	
<p>Write Command</p> <p>If PDU mode (AT+CMGF=0):</p> <p>AT+CMSS=<index>[, <da>[, <toda>]]</p> <p>Response(s)</p> <p>+CMSS: <mr>[, <ackpdu>]</p> <p>OK</p> <p>If sending fails</p> <p>ERROR</p> <p>+CMS ERROR</p>	
<p>Reference(s)</p> <p>GSM 07.05</p>	

Command Description

The write command sends message with location value <index> from message storage <mem2> to the network (SMS-SUBMIT or SMS-COMMAND). If new recipient address <da> is given for SMS-SUBMIT, it shall be used instead of the one stored with the message. Reference value <mr> is returned to the TE on successful message delivery. Value can be used to identify message upon unsolicited delivery status report result code. If the optional parameter <da> is given, the old status of the short message at <index> remains unchanged (see <stat>).

13.10 AT+CNMA New SMS message acknowledge to ME/TE, only phase 2+

Syntax

<p>Test Command</p> <p>AT+CNMA=?</p> <p>Response(s)</p> <p>+CNMA: (list of supported <n>s)</p> <p>OK</p>	
<p>Exec Command</p> <p>AT+CNMA</p> <p>Response(s)</p> <p>OK</p> <p>ERROR</p> <p>+CMS ERROR</p>	
<p>Write Command</p> <p>AT+CNMA=<n></p> <p>Response(s)</p> <p>OK</p> <p>ERROR</p> <p>+CMS ERROR</p>	
<p>Reference(s)</p> <p>GSM 07.05</p>	<p>PIN ASC0 ASC1 USB MUX1 MUX2 MUX3 Charge → Last</p> <p>● ● ● ● ● ● ○ ● ○</p>

Command Description

The write / execute command confirms successful receipt of a new message (SMS-DELIVER or SMS-STATUS-REPORT) routed directly to the TE. TA shall not send another +CMT or +CDS result code to TE until previous one is acknowledged. If ME does not receive acknowledgment within required time (network time-out), ME sends RP-ERROR to the network. TA shall automatically disable routing to TE by setting both <mt> and <ds> values of AT+CNMI to zero.

Parameter Description

<n> ^(num)	
0	Parameter is only required for PDU mode. Command operates similarly as in text mode

Notes

- The execute / write command shall only be used when AT+CSMS parameter <service> equals 1 (= phase 2+).
- Both the execute and the write command can be used no matter whether text mode or PDU mode is activated.
- If multiplex mode is activated (AT+CMUX=0) the AT+CNMI parameter will be set to zero on all channels, if one channel fails to acknowledge an incoming message within the required time.

13.11 AT+CNMI New SMS message indications

Syntax

<p>Test Command</p> <p>AT+CNMI=?</p> <p>Response(s)</p> <p>+CNMI: (list of supported <mode>s), (list of supported <mt>s), (list of supported <bm>s), (list of supported <ds>s), (list of supported <bfr>s)</p> <p>OK</p>	
<p>Read Command</p> <p>AT+CNMI?</p> <p>Response(s)</p> <p>+CNMI: <mode>, <mt>, <bm>, <ds>, <bfr></p> <p>OK</p>	
<p>Write Command</p> <p>AT+CNMI=[<mode>][, <mt>][, <bm>][, <ds>][, <bfr>]</p> <p>Response(s)</p> <p>OK</p> <p>ERROR</p> <p>+CMS ERROR</p>	
<p>Reference(s)</p> <p>GSM 07.05</p>	<p>PIN ASC0 ASC1 USB MUX1 MUX2 MUX3 Charge → Last</p> <p>● ● ● ● ● ● ● ○ ● ○</p>

Unsolicited Result Codes

URC 1

<mt>=1:
+CMTI: <mem3>, <index>
Indicates that new message has been received

URC 2

<mt>=2 (PDU mode enabled):
+CMT: <length><CR><LF><pdu>
Indicates that new message has been received

URC 3

<mt>=2 (text mode enabled):
+CMT: <oa>, <scts>[, <toa>, <fo>, <pid>, <dcs>, <sca>, <tosca>, <length>] <CR><LF><data>
Indicates that new message has been received

URC 4

<bm>=2 (PDU mode enabled):
+CBM: <length><CR><LF><pdu>
Indicates that new cell broadcast message has been received

URC 5

<bm>=2 (text mode enabled):

+CBM: <sn>, <mid>, <dcs>, <page>, <pages><CR><LF><data>

Indicates that new cell broadcast message has been received

URC 6

<ds>=1 (PDU mode enabled):

+CDS: <length><CR><LF><pdu>

Indicates that new SMS status report has been received

URC 7

<ds>=1 (text mode enabled):

+CDS: <fo>, <mr>[, <ra>][, <tora>], <scts>, <dt>, <st>

Indicates that new SMS status report has been received

URC 8

<ds>=2:

+CDSI: <mem3>, <index>

Indicates that new SMS status report has been received

Command Description

The write command selects the procedure how the receipt of new SMS messages from the network is indicated to the TE when TE is active, e.g. DTR signal is ON. If TE is inactive (e.g. DTR signal is OFF), message receiving should be done as specified in GSM 03.38. If the DTR signal is not available or the state of the signal is ignored (V.250 command AT&D0, reliable message transfer can be assured by using AT+CNMA acknowledgment procedure. The rules <mt>=2 and <mt>=3 for storing received SM are possible only if phase 2+ compatibility is activated with AT+CSMS=1. The parameter <ds>=1 is only available in phase 2+

Parameter Description

<mode> ^{(num)(&W)}	
[0] ^(&F)	Buffer unsolicited result codes in the TA. If TA result code buffer is full, indications can be buffered in some other place or the oldest indications may be discarded and replaced with the new received indications.
1	Discard indication and reject new received message unsolicited result codes when TA-TE link is reserved (e.g. in on-line data mode). Otherwise forward them directly to the TE.
2	Buffer unsolicited result codes in the TA when TA-TE link is reserved (e.g. in on-line data mode) and flush them to the TE after reservation. Otherwise forward them directly to the TE.
3	Forward unsolicited result codes directly to the TE. TA-TE link specific inband technique used to embed result codes and data when TA is in on-line data mode.

<mt> ^{(num)(&W)(&V)}	
Rules for storing received SMS depend on the relevant data coding method (refer to GSM 03.38), preferred memory storage (AT+CPMS) setting and this value. Note: If AT command interface is acting as the only display device, the ME must support storage of class 0 messages and messages in the message waiting indication group (discard message)	
[0] ^(&F)	No SMS-DELIVER indications are routed to the TE.
1	If SMS-DELIVER is stored in ME/TA, indication of the memory location is routed to the TE using unsolicited result code:

- | | |
|---|---|
| 2 | SMS-DELIVERs, except class 2 messages and messages in the message waiting indication group (store message) are routed directly to the TE using unsolicited result code: |
| 3 | Class 3 SMS-DELIVERs are routed directly to the TE using unsolicited result codes defined in <code><mt>=2</code> . Messages of other data coding schemes result in indication as defined in <code><mt>=1</code> . |

`<bm>`^{(num)(&W)(&V)}

Rules for storing received CBMs depend on the relevant data coding method (refer to GSM 03.38), the setting of Select CBM Types ([AT+CSCB](#)) and this value:

- | | |
|--------------------------------------|--|
| <code>[0]</code> ^(&F) | No CBM indications are routed to the TE. |
| 2 | New CBMs are routed directly to the TE using unsolicited result code: |
| 3 | Class 3 CBMs are routed directly to TE using unsolicited result codes defined in <code><bm>=2</code> . |

`<ds>`^{(num)(&W)(&V)}

- | | |
|--------------------------------------|---|
| <code>[0]</code> ^(&F) | No SMS-STATUS-REPORTs are routed to the TE. |
| 1 | SMS-STATUS-REPORTs are routed to the TE using unsolicited result code: |
| 2 | If SMS-STATUS-REPORT is routed into ME/TA, indication of the memory location is routed to the TE using unsolicited result code: |

`<bfr>`^{(num)(&V)}

- | | |
|--------------------------------------|--|
| <code>[1]</code> ^(&F) | TA buffer of unsolicited result codes defined within this command is cleared when <code><mode></code> changes from 0 to 1...3. |
|--------------------------------------|--|

`<index>`^(num)

Integer type; value in the range of location numbers supported by the associated memory

Notes

- Each time an SMS or Cell Broadcast Message is received, the Ring Line goes Logic "1" for one second.
- Parameters `<mt>=2,3` and `<ds>=1` are only available with GSM phase 2+ (see [AT+CSMS=1](#)). Incoming SMS or Status Reports have to be acknowledged with [AT+CNMA=0](#) when using these phase 2+ parameters.
- Requirements specific to Multiplex mode:
In multiplex mode ([AT+CMUX=0](#)) only one channel can use a phase 2+ parameter. The parameter for `<mt>` and `<ds>` on the other channels have to be set to zero. If either a SM or a Status Report is not acknowledged, all [AT+CNMI](#) parameter in all channels will be set to zero.
- If the ME operates on different instances (MUX channels 1, 2, 3 or ASC0/ASC1) avoid different settings for routing and indicating SMS. For example, if messages shall be routed directly to one instance of the TE (set with [AT+CNMI](#), [AT^SSDA](#)), it is not possible to activate the presentation of URCs with [AT+CMER](#) or [AT+CNMI](#) on another instance. Any attempt to activate settings that conflict with existing settings on another interface, will result in CME ERROR, or accordingly CMS ERROR.
- Handling of Class 0 short messages:
If the host application is provided with a display and [AT^SSDA=1](#) has been set Class 0 short messages can be displayed immediately.
If the host application does not include a display, ME handles Class 0 short messages as though there was no message class, i.e. it will ignore bits 0 and 1 in the `<dcs>` and normal rules for exceeded memory capacity shall apply. This approach is compliant with GSM 03.38 .
- The parameters `<ra>` and `<tora>` will only be displayed if `<ra>` of the [AT^SSCONF](#) command is set to 1.
- If either a SM or a Status Report is not acknowledged, all [AT+CNMI](#) parameter in all channels will be set to zero.

13.12 AT+CPMS Preferred SMS message storage

Syntax

<p>Test Command</p> <pre>AT+CPMS=?</pre> <p>Response(s)</p> <pre>+CPMS: (list of supported <mem1>s), (list of supported <mem2>s), (list of supported <mem3>s) OK</pre>	
<p>Read Command</p> <pre>AT+CPMS?</pre> <p>Response(s)</p> <pre>+CPMS: <mem1>, <used1>, <total1>, <mem2>, <used2>, <total2>, <mem3>, <used3>, <total3> OK ERROR ERROR +CMS ERROR</pre>	
<p>Write Command</p> <pre>AT+CPMS=<mem1>[, <mem2>[, <mem3>]]</pre> <p>Response(s)</p> <pre>+CPMS: <used1>, <total1>, <used2>, <total2>, <used3>, <total3> OK ERROR ERROR +CMS ERROR</pre>	
<p>Reference(s)</p> <p>GSM 07.05</p>	

Command Description

The write command selects memory storages [<mem1>](#), [<mem2>](#), [<mem3>](#) to be used for reading, writing, etc.

Parameter Description

[<used1>](#)^(num)

Number of messages currently in [<mem1>](#)

[<used2>](#)^(num)

Number of messages currently in [<mem2>](#)

[<used3>](#)^(num)

Number of messages currently in [<mem3>](#)

[<total1>](#)^(num)

Number of messages storable in [<mem1>](#)

[<total2>](#)^(num)

Number of messages storable in [<mem2>](#)

<total3>^(num)

Number of messages storable in <mem3>

Notes

- The Mobile Equipment storage "ME" offers space for 25 short messages, see <mem1>.
- "MT" is the sum of "ME" (= 25 locations) and "SM" (capacity varies with SIM card). The indices <index> of the "MT" storage are dependent on the order selected with [AT^SSMSS](#)
- The <mem1>, <mem2> and <mem3> parameter will be stored in non-volatile memory.
- The user should be aware that the setting "MT" involves "ME" and "SM", with "ME" being filled up first. If the "ME" storage is full, TC65 will proceed with the "SM" storage.
Incoming Class 1 short messages (ME specific) will be preferably stored to "ME" and may be transferred to the "SM" storage if "ME" is used up.
Incoming Class 2 messages (SIM specific) will be stored to the SIM card only, no matter whether or not there is free "ME" space. As a result, the ^SMGO: 2 indication (see [AT^SMGO](#)) may be presented without prior indication of ^SMGO: 1. For more information regarding SIM and ME specific message classes refer to <dcs> and the following specifications: GSM 03.38 and 3GPP TS23038.
- Multiplexer: In Multiplex mode or when the two physical serial interfaces are connected, the parameter <mem3> will be the same on all instances, but the settings of <mem1> and <mem2> may vary on each channel / interface. As a result, changes on parameter <mem1> and/or <mem2> before activating the multiplexer or differences values for other instances can result in not desired behaviours like different outputs for [AT+CMGL](#) and so on.
- While <mem3> equals "SM" and <mem1> equals "ME" it is possible that, after deleting short messages from "ME", the freed space on "ME" is reclaimed for new incoming short messages, when there is no space left on the "SM" storage. As it is often the clients concern to have received short messages stored only to the SIM card, inconsistent settings should be generally avoided. This can be achieved simply by using the same parameter for all memory indices.
- The indices <index> of the storage are dependent on the order selected with [AT^SSMSS](#).

13.13 AT+CSCA SMS service centre address

Syntax

Test Command	
AT+CSCA=?	
Response(s)	
OK	
Read Command	
AT+CSCA?	
Response(s)	
+CSCA: <sca>, <tosca>	
OK	
Write Command	
AT+CSCA=<sca>[, <tosca>]	
Response(s)	
OK	
Reference(s)	
GSM 07.05	

PIN	ASC0	ASC1	USB	MUX1	MUX2	MUX3	Charge	✈	Last
●	●	●	●	●	●	●	○	●	○

Command Description

Write command updates the SMSC address, through which mobile originated SMS are transmitted. In text mode, setting is used by send and write commands. In PDU mode, setting is used by the same commands, but only when the length of the SMSC address coded into <pdu> parameter equals zero.

Notes

- In case of using no parameter after AT+CSCA= the content of <sca> will be deleted
- This command writes the service centre address to non-volatile memo
- The SMS service centre address should be entered as specified by the service provider

13.14 AT+CSCB Select Cell Broadcast Message Indication

Syntax

<p>Test Command</p> <pre>AT+CSCB=?</pre> <p>Response(s)</p> <pre>+CSCB: (list of supported <mode>s) OK</pre>	
<p>Read Command</p> <pre>AT+CSCB?</pre> <p>Response(s)</p> <pre>+CSCB: <mode>, <mids>, <dcss> OK</pre>	
<p>Write Command</p> <pre>AT+CSCB=[<mode>[, <mids>[, <dcss>]]]</pre> <p>Response(s)</p> <pre>OK</pre>	
<p>Reference(s)</p> <p>GSM 07.05</p>	

Command Description

Test command returns supported modes as a compound value.

Write command selects which types of CBMs are to be received by the ME.

Parameter Description

<mode>^(num)	
Message mode	
[0]	Accept messages that are defined in <mids> and <dcss>
1	Forbid messages that are defined in <mids> and <dcss>
<mids>^(str)	
Cell Broadcast Message ID specification	
<ul style="list-style-type: none"> For <mode>=0: Six different possible combinations of CBM IDs (e.g. "0,1,5,320-478,922,2000-3000"), default is empty string. In certain configurations, e.g. if using SIMs that contain data in Elementary File EF-CBMID (Cell Broadcast Message Identifier for Data download) less than six combinations may be available. To access a SIM's Elementary File data refer to command AT+CRSM. For <mode>=1: One CBM ID or range of IDs (e.g. "320-478"), default is empty string. 	
<dcss>^(str)	
CBM data coding scheme specification	
All different possible combinations of CBM data coding schemes (e.g. "0-3,5"). Using default empty string leads to get all CBMs independent of their dcscs.	
A given <dcss> replaces any former value and is used for consecutive requests.	

13.15 AT+CSDH Show SMS text mode parameters

Syntax

<p>Test Command</p> <pre>AT+CSDH=?</pre> <p>Response(s)</p> <pre>+CSDH: ((list of supported <show>s) OK</pre>	
<p>Read Command</p> <pre>AT+CSDH?</pre> <p>Response(s)</p> <pre>+CSDH: <show> OK</pre>	
<p>Write Command</p> <pre>AT+CSDH=<show></pre> <p>Response(s)</p> <pre>+CSDH: <show> OK</pre>	
<p>Reference(s)</p> <pre>GSM 07.05</pre>	

Command Description

Write command sets whether or not detailed header information is shown in text mode result codes.

Parameter Description

<code><show></code> ^{(num)(&W)}	
<code>[0]</code> ^(&F)	Do not show header values defined in commands <code>AT+CSCA</code> and <code>AT+CSMP</code> (<code><sca></code> , <code><tosca></code> , <code><fo></code> , <code><vp></code> , <code><pid></code> and <code><dcs></code>) nor <code><length></code> , <code><toda></code> or <code><tooa></code> in "+CMTI", <code>AT+CMGL</code> , <code>AT+CMGR</code> result codes for SMS-DELIVERs and SMS-SUBMITs in text mode; for SMS-COMMANDs in +CMGR result code, do not show <code><pid></code> , <code><mn></code> , <code><da></code> , <code><toda></code> , <code><length></code> or <code><cdata></code>
1	Show the values in result codes

13.16 AT+CSMP Set SMS text mode parameters

Syntax

<p>Test Command</p> <pre>AT+CSMP=?</pre> <p>Response(s)</p> <pre>OK</pre>	
<p>Read Command</p> <pre>AT+CSMP?</pre> <p>Response(s)</p> <pre>+CSMP: <fo>, <vp>/ <scts>, <pid>, <dc></pre> <pre>OK</pre>	
<p>Write Command</p> <pre>AT+CSMP=<fo>[, <vp>/<scts>[, <pid>[, <dc>]]]</pre> <p>Response(s)</p> <pre>+CSMP: <index></pre> <pre>OK</pre> <p>If sending fails</p> <pre>ERROR</pre> <pre>+CMS ERROR</pre>	
<p>Reference(s)</p> <pre>GSM 07.05</pre>	

Command Description

The write command selects values for additional parameters needed when SM is sent to the network or placed in a storage when text format message mode is selected.

It is possible to set the validity period starting from when the SM is received by the SMSC (<vp> is in range 0...255) or define the absolute time of the validity period termination (<vp> is a string). The format of <vp> is given by <fo>. If TA supports the enhanced validity period format, see GSM 03.40), it shall be given as a hexadecimal coded string (e.g. <pdu>) with quotes.

Parameter Description

<fo>^(num)

First Octet

depending on the command or result code: first octet of GSM 03.40 SMS-DELIVER, SMS-SUBMIT (default 17), SMS-STATUS-REPORT, or SMS-COMMAND (default 2) in integer format

0...17^(&F)...255

<vp>^(num)

Depending on SMS-SUBMIT <fo> setting: GSM 03.40 TP-Validity-Period either in integer format or in time-string format (refer <dt>)

0...167^(&F)...255

<dc>^(num)

Data Coding Scheme

GSM 03.38 SMS Data Coding Scheme, or Cell Broadcast Data Coding Scheme in integer format

0^(&F)...247

<pid>^(num)

Protocol Identifier

GSM 03.40 TP-Protocol-Identifier in integer format

0^(&F)...255

Notes

- When storing a SMS DELIVER from the TE to the preferred memory storage in text mode (using the [AT+CMGW](#) write command), <vp> field can be used for <scts>.
- The command writes the parameters to the non-volatile memory.

13.17 AT+CSMS Select Message Service

Syntax

<p>Test Command</p> <p>AT+CSMS=?</p> <p>Response(s)</p> <p>+CSMS: (list of supported<service>s)</p> <p>OK</p>	
<p>Read Command</p> <p>AT+CSMS?</p> <p>Response(s)</p> <p>+CSMS: <service>, <mt>, <mo>, <bm></p> <p>OK</p>	
<p>Write Command</p> <p>AT+CSMS=<service></p> <p>Response(s)</p> <p>+CSMS: <mt>, <mo>, <bm></p> <p>OK</p> <p>ERROR</p> <p>+CMS ERROR</p>	
<p>Reference(s)</p> <p>GSM 07.05</p>	

Parameter Description

<service> ^{(num)(&W)(&V)}	
0(&F)	GSM 03.40 and GSM 03.41 (the syntax of SMS AT commands is compatible with GSM 07.05 Phase 2 version 4.7.0; Phase 2+ features which do not require new command syntax may be supported, e.g. correct routing of messages with new Phase 2+ data coding schemes)
1	GSM 03.40 and GSM 03.41 (the syntax of SMS AT commands is compatible with GSM 07.05 Phase 2+ version; the requirement of <service> setting 1 is mentioned under corresponding command descriptions).

<mt> ^(num)	
Mobile Terminated Messages:	
0	Type not supported
1	Type supported

<mo> ^(num)	
Mobile Originated Messages:	
0	Type not supported
1	Type supported

<bm>^(num)

Broadcast Type Messages:

0	Type not supported
1	Type supported

Notes

- If CSMS mode is switched from Phase 2+ to Phase 2 and one or more [AT+CNMI](#) Parameter are Phase 2+ specific a '+CMS ERROR: unknown error' will appear. It is recommended to switch the [AT+CNMI](#) Parameters to Phase 2 specific values before entering Phase 2.
- Phase 2+ (<service>=1) must be set before the following features can be used:
 - Configuring procedures for indicating received short messages with the [AT+CNMI](#) parameters <mt>=2 or <mt>=3 and <ds>=1.
 - Acknowledging incoming short messages with [AT+CNMA](#).
 - Receiving Status Reports and acknowledging them with [AT+CNMA](#).

13.18 AT^SCML List Concatenated SMS messages from preferred store

Syntax

Test Command

AT^SCML=?

Response(s)

^SCML: (list of supported <stat>s)

OK

Exec Command

AT^SCML

Response(s)

^SCML: (see write command for default of <stat>)

OK

Write Command

AT^SCML=<stat>

Response(s)

Output if text mode (AT+CMGF=1) and command successful:

For SMS-SUBMITs and/or SMS-DELIVERs

^SCML: <index>, <stat>, <oa>/<da>, [<alpha>], [<scts>][, <toa>/<tda>, <length>][, <seq>, <max>, <ieia>, <ref>]

<data>

[...]

OK

For SMS-STATUS-REPORTs

^SCML: <index>, <stat>, <fo>, <mr>, [<ra>], [<tora>], <scts>, <dt>, <st>

[...]

OK

For SMS-Commands

^SCML: <index>, <stat>, <fo>, <ct>

[...]

OK

Output if PDU mode (AT+CMGF=0) and command successful:

For SMS- SUBMITs and/or SMS-DELIVERs

^SCML: <index>, <stat>, [<alpha>], <length>

<pdu>

[...]

OK

If error is related to ME functionality

ERROR

+CMS ERROR

Reference(s)

SIEMENS

PIN ASC0 ASC1 USB MUX1 MUX2 MUX3 Charge → Last

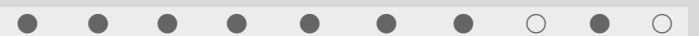

Command Description

The execute command is the same as the write command with the given default for [<stat>](#).

The write command returns messages with status value [<stat>](#) from message storage [<mem1>](#) to the TE. If status of the message is 'received unread', status in the storage changes to 'received read'.

Note

- See notes of [AT+CMGL](#).

13.19 AT^SCMR Read concatenated SMS messages

Syntax

Test Command

AT^SCMR=?

Response(s)

OK

Write Command

AT^SCMR=<index>

Response(s)

Output if text mode (AT+CMGF=1) and command successful:

For SMS-DELIVER

^SCMR: <stat>, <oa>, [<alpha>], <scts>[, <tooa>, <fo>, <pid>, <dcsc>, <sca>, <tosca>, <length>][, <seq>, <max>, <ieia>, <ref>]
<data>

[...]

OK

For SMS-SUBMIT

^SCMR: <stat>, <da>, [<alpha>][, <toda>, <fo>, <pid>, <dcsc>, [<vp>], <sca>, <tosca>, <length>][, <seq>, <max>, <ieia>, <ref>]
<data>

[...]

OK

For SMS-STATUS-REPORT

^SCMR: <stat>, <fo>, <mr>, [<ra>], [<tora>], <scts>, <dt>, <st>
<data>

[...]

OK

For SMS-Commands

^SCMR: <stat>, <fo>, <ct>[, <pid>, [<mn>], [<da>], [<toda>], <length>
<data>

[...]

OK

Output if PDU mode (AT+CMGF=0) and command successful:

For SMS-SUBMITs and/or SMS-DELIVERs

^SCMR: <stat>, [<alpha>], <length>
<pdu>

[...]

OK

ERROR

+CMS ERROR

Reference(s)

SIEMENS

PIN ASC0 ASC1 USB MUX1 MUX2 MUX3 Charge → Last

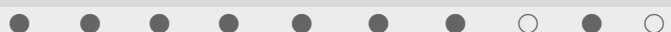

Command Description

The write command returns the message with location value [<index>](#) from message storage [<mem1>](#) to the TE. If status of the message is 'received unread', status in the storage changes to 'received read'. See notes of [AT+CMGR](#).

13.20 AT^SCMS Send concatenated SMS messages

Sending a concatenated message is similar to sending a "normal" message, except that each segment of the concatenated message must be identified by the additional parameters `<seq>`, `<ieia>` and `<ref>`. To send all segments of the message one by one, the `AT^SCMS` write command must be executed for each segment.

Syntax

<p>Test Command</p> <p>AT^SCMS=?</p> <p>Response(s)</p> <p>OK</p>	
<p>Write Command</p> <p>Command syntax for text mode (see <code>AT+CMGF=1</code>):</p> <p>AT^SCMS=<da>[, <tda>], <seq>, <max>, <ieia>, <ref><CR> Text can be entered <CTRL-Z>/<ESC></p> <p>Response(s)</p> <p>+CMGS: <mr>[, <scts>]</p> <p>OK</p> <p>If sending fails</p> <p>ERROR</p> <p>+CMS ERROR</p>	
<p>Reference(s)</p> <p>SIEMENS</p>	

Command Description

The write command transmits one segment of a concatenated short message from TE to network (SMS-SUBMIT).

After invoking the write command wait for the prompt ">" and then start to write the message. To send the message simply enter <CTRL-Z>. After the prompt a timer will be started to observe the input.

To abort sending use <ESC>. Abortion is acknowledged with "OK", though the message will not be sent.

The message reference `<mr>` is returned to the TE on successful message delivery. The value can be used to identify the message in a delivery status report provided as an unsolicited result code.

Notes

- See notes provided for `AT+CMGS`.
- Command is only available if `AT+CMGF=1`.

13.21 AT^SCMW Write concatenated SMS messages to memory

Writing a concatenated message to the memory is similar to writing a "normal" message, except that each segment of the concatenated message must be identified by the additional parameters `<seq>`, `<ieia>` and `<ref>`. To store all segments of the message one by one, the `AT^SCMW` write command must be executed for each segment.

Syntax

<p>Test Command</p> <p>AT^SCMW=?</p> <p>Response(s)</p> <p>OK</p>	<p>Write Command</p> <p>If text mode (see AT+CMGF=1)</p> <p>AT^SCMW=<oa>/<da>, [<tooa>/<toda>][, <stat>], <seq>, <max>, <ieia>, <ref><cr> Text can be entered. <CTRL-Z>/<ESC></p> <p>Response(s)</p> <p>^SCMW: <index></p> <p>OK</p> <p>If writing fails</p> <p>ERROR</p> <p>+CMS ERROR</p>
<p>Reference(s)</p> <p>SIEMENS</p>	

Command Description

The write commands transmits one segment of a concatenated SMS (either SMS-DELIVER or SMS-SUBMIT) from TE to memory storage `<mem2>`. Memory location `<index>` of the stored message is returned. Message status will be set to 'stored unsent' unless otherwise given in parameter `<stat>`.

Notes

- Command is only available if [AT+CMGF=1](#).
- To send or delete a concatenated short message please use the known SMS commands, see [AT+CMSS](#) for sending and [AT+CMGD](#) for deleting.
- See notes provided for [AT+CMGW](#).

13.22 AT^SLMS List SMS Memory Storage

Syntax

Test Command	
AT^SLMS=?	
Response(s)	
OK	
Exec Command	
AT^SLMS	
Response(s)	
^SLMS: "MT",<total3>, <used3>	
^SLMS: "SM",<total1>, <used1>	
^SLMS: "ME",<total2>, <used2>	
OK	
ERROR	
+CMS ERROR	
Reference(s)	
SIEMENS	



Command Description

The execute command indicates the maximum capacity of each SMS storage type and the number of locations currently used.

Parameter Description

- <total1>^(num)**
Maximum number of messages storable in the SMS memory of the SIM (physical storage "SM")
- <total2>^(num)**
Maximum number of messages storable in the SMS memory of the Mobile Equipment (physical storage "ME")
- <total3>^(num)**
Sum of "SM" and "ME", indicated as "MT". Maximum number of all messages storable in the SIM memory and the Mobile Equipment memory.
- <used1>^(num)**
Number of messages currently stored in the SMS memory of the SIM (physical storage "SM")
- <used2>^(num)**
Number of messages currently stored in the SMS memory of the Mobile Equipment (physical storage "ME")
- <used3>^(num)**
Concatenated logical SMS storages of SIM ("SM") and Mobile Equipment ("ME"). Sum of all messages currently stored, indicated as "MT".

13.23 AT^SMGL List SMS messages from preferred store without setting status to REC READ

Syntax

<p>Test Command</p> <p>AT^SMGL=?</p> <p>Response(s)</p> <p>same as AT+CMGL</p>	
<p>Exec Command</p> <p>AT^SMGL</p> <p>Response(s)</p> <p>^SMGL: (For default values of <stat>, see Chapter "SMS parameters.)</p> <p>OK</p>	
<p>Write Command</p> <p>AT^SMGL=<stat></p> <p>Response(s)</p> <p>same as AT+CMGL</p>	
<p>Reference(s)</p> <p>SIEMENS</p>	

Command Description

The execute command is the same as the write command, but uses the given default of <stat>.

The write command allows to select a status type and lists, from the message storage <mem1>, all messages that currently have the specified <stat>. The major difference over the standard command [AT+CMGL](#) is that the status of the listed messages remains unchanged (unread remains unread).

Notes

- The selected <mem1> can contain different types of SMs (e.g. SMS-DELIVERs, SMS-SUBMITs, SMS-STATUS-REPORTs and SMS-COMMANDs), the response may be a mix of the responses of different SM types. TE application can recognize the response format by examining the third response parameter.
- This command can be used only after the SMS data from the SIM have been read successfully for the first time. Reading starts after successful SIM authentication has been performed, and may take up to 30 seconds depending on the SIM used. While the read process is in progress, an attempt to use any of the sms read commands will result in "+CME Error: 14" (SIM busy)
- We recommend to take advantage of the "SSIM READY" URC. If enabled with [AT^SSET](#), this URC acknowledges to the user that SIM data is accessible after SIM PIN authentication. It will be delivered once the ME has completed reading data from the SIM card.
- If the ME is Java controlled, take into account that the AT Command API can handle responses up to a length of 1024 bytes. To avoid any longer re-sponses it is recommended not to read the entire range of short message entries at a time.

13.24 AT^SMGO Set or query SMS overflow presentation mode or query SMS overflow

Syntax

<p>Test Command</p> <p>AT^SMGO=?</p> <p>Response(s)</p> <p>^SMGO: (list of supported<n>s)</p> <p>OK</p>	
<p>Read Command</p> <p>AT^SMGO?</p> <p>Response(s)</p> <p>^SMGO: <n>, <mode></p> <p>OK</p> <p>ERROR</p> <p>+CMS ERROR</p>	
<p>Write Command</p> <p>AT^SMGO=<n></p> <p>Response(s)</p> <p>OK</p> <p>ERROR</p> <p>CME ERROR</p>	
<p>Reference(s)</p> <p>SIEMENS</p>	<p>PIN ASC0 ASC1 USB MUX1 MUX2 MUX3 Charge ↗ Last</p> <p>● ● ● ● ● ● ○ ● ○</p>

Unsolicited Result Code

SMS buffer change:

^SMGO: <mode>

Status of SMS buffer has changed.

Command Description

The read command returns overflow presentation mode and SMS overflow status

The write command sets overflow presentation mode

Parameter Description

<n> ^{(num)(&W)(&V)}	
SMS overflow presentation mode	
[0] ^(&F)	disable
1	enable
<mode> ^{(num)(&V)}	
SMS overflow status	
0	space available

-
- | | |
|---|--|
| 1 | SMS buffer full (The buffer for received short messages is <mem3> . See AT+CPMS .) |
| 2 | Buffer full and new message waiting in SC for delivery to phone |

Notes

- Incoming short messages with message class 1 (ME specific short messages) or class 2 (SM specific short messages), see [<dcs>](#) in GSM 03.38, will be stored either in "ME" or in "SM" storage. Therefore the "[^SMGO: 2](#)" indication could occur, without issuing the indication "[^SMGO: 1](#)" before. The indication "[^SMGO: 1](#)" means that both buffers ("ME" and "SM") are full.
- For more information regarding SIM and ME specific message classes refer to [<dcs>](#) and the following specifications: GSM 03.38 and 3GPP TS 23.038 .

13.25 AT^SMGR Read SMS message without setting status to REC READ

Syntax

Test Command	AT^SMGR=?																				
Response(s)	^SMGR: OK																				
Write Command	AT^SMGR=<index>																				
Response(s)	see AT+CMGR																				
Reference(s)	SIEMENS																				
	<table border="1"><tr><td>PIN</td><td>ASC0</td><td>ASC1</td><td>USB</td><td>MUX1</td><td>MUX2</td><td>MUX3</td><td>Charge</td><td>→</td><td>Last</td></tr><tr><td>●</td><td>●</td><td>●</td><td>●</td><td>●</td><td>●</td><td>●</td><td>○</td><td>●</td><td>○</td></tr></table>	PIN	ASC0	ASC1	USB	MUX1	MUX2	MUX3	Charge	→	Last	●	●	●	●	●	●	●	○	●	○
PIN	ASC0	ASC1	USB	MUX1	MUX2	MUX3	Charge	→	Last												
●	●	●	●	●	●	●	○	●	○												

Notes

- The [AT^SMGR](#) command is a specific Siemens command with the same syntax as [AT+CMGR](#) Read SMS message. The only difference is that the status "REC UNREAD" of a short message is not overwritten to "REC READ".
- This command can be used only after the sms data from the SIM have been read successfully for the first time. Reading starts after successful SIM authentication has been performed, and may take up to 30 seconds depending on the SIM used. While the read process is in progress, an attempt to use any of the sms read commands will result in "+CME Error: 14" (SIM busy)
- We recommend to take advantage of the "^SSIM READY" URC. If enabled with [AT^SSET](#), this URC acknowledges to the user that SIM data is accessible after SIM PIN authentication. It will be delivered once the ME has completed reading data from the SIM card.

13.26 AT^SSCONF SMS Command Configuration

[AT^SSCONF](#) controls details of some SMS related commands. Please note that [AT^SSCONF](#) settings are stored volatile, i.e. after restart or reset the default values will be restored.

Syntax

<p>Test Command</p> <p>AT^SSCONF=?</p> <p>Response(s)</p> <p>^SSCONF : list of supported <ra>s</p> <p>OK</p>
<p>Read Command</p> <p>AT^SSCONF?</p> <p>Response(s)</p> <p>^SSCONF : <ra></p> <p>OK</p>
<p>Write Command</p> <p>AT^SSCONF=<ra></p> <p>Response(s)</p> <p>OK</p>

PIN	ASC0	ASC1	USB	MUX1	MUX2	MUX3	Charge	✈	Last
<input type="radio"/>	<input checked="" type="radio"/>	<input checked="" type="radio"/>	<input checked="" type="radio"/>	<input checked="" type="radio"/>	<input checked="" type="radio"/>	<input checked="" type="radio"/>	<input type="radio"/>	<input checked="" type="radio"/>	<input type="radio"/>

Parameter Description

<ra> ^(num)	
Display recipient address	
[0] ^(&F)	TC65 does not display <ra> and <tora>. These parameters are used with the result codes of AT+CMGL , AT^SMGL , AT+CMGR , AT^SMGR and the URC "+CDS".
1	TC65 displays <ra> and <tora>.

13.27 AT^SSDA Set SMS Display Availability

This command allows to notify the TC65 of its controlling application's capability to immediately display incoming SMS on a display.

If the application is able to display incoming SMS, class 0 SMS shall be displayed immediately. However, if it does not, class 0 SMS shall be treated as if no message class is determined (GSM 03.38[20]).

The effect of this command if `<da>=1` is to determine the behavior of parameter `<mt>` of `AT+CNMI`:

If `<da>=1` and `<mt>=1` incoming class 0 SMS need to be acknowledged with `AT+CNMA` (see also `AT+CNMI` and `AT+CSMS`)

If multiplex mode is enabled (`AT+CMUX`) and `<da>=1` with `<mt>=1` is set on any logical channel, all other channels have to use `<mt>=0`.

Syntax

<p>Test Command</p> <pre>AT^SSDA=?</pre> <p>Response(s)</p> <pre>^SSDA: list of supported <da>s OK</pre>	
<p>Read Command</p> <pre>AT^SSDA?</pre> <p>Response(s)</p> <pre>^SSDA: <da> OK</pre>	
<p>Write Command</p> <pre>AT^SSDA=<da></pre> <p>Response(s)</p> <pre>OK</pre>	
<p>Reference(s)</p> <p>SIEMENS</p>	

Command Description

The read command returns ME's current capability setting.

Parameter Description

<code><da></code> ^(num)	Display Availability
0(&F)	Application is not able to display incoming SMS
1	Application is able to display incoming SMS

Note

- If the ME operates on different instances (MUX channels 1, 2, 3 or ASC0/ASC1) avoid different settings for routing and indicating SMS. For example, if messages shall be routed directly to one instance of the TE (set with `AT+CNMI`, `AT^SSDA`), it is not possible to activate the presentation of URCs with `AT+CMER` or `AT+CNMI` on another instance. Any attempt to activate settings that conflict with existing settings on another interface, will result in CME ERROR, or accordingly CMS ERROR.

13.28 AT^SSMSS Set Short Message Storage Sequence

Syntax

<p>Test Command</p> <p>AT^SSMSS=?</p> <p>Response(s)</p> <p>^SSMSS: (list of supported) <seq>s</p>	
<p>Read Command</p> <p>AT^SSMSS?</p> <p>Response(s)</p> <p>^SSMSS: <seq></p> <p>OK</p>	
<p>Write Command</p> <p>AT^SSMSS=<seq></p> <p>Response(s)</p> <p>OK</p>	
<p>Reference(s)</p> <p>SIEMENS</p>	

Command Description

The short message storage "MT" (see [AT+CPMS](#)) is a logical storage. It consists of two physical storages "ME" and "SM". This command allows to select the sequence of addressing this storage.

Parameter Description

<seq> ^(num)	
MT sequence	
0(&F)	"MT" storage is "ME" then "SM"
1	"MT" storage is "SM" then "ME"

Note

- Access to the SIM storage is faster. For compatibility with previous software re-leases, the "MT" sequence <seq>=0 is the factory default.

14. SIM related Commands

The AT commands described in this chapter are related to the Subscriber Identity Module (SIM) connected to TC65.

Note:

If using data from the SIM please bear in mind that the content of all Elementary Files is *subject to change* at any moment!

This is true because the network can change the SIM's data in the background via the SIM Application Toolkit (SAT) procedure "Data download to SIM". For a detailed description please refer to GSM 11.14, [25].

To get informed that changing Elementary Files has taken place the TA needs to hook to the SAT Proactive Command "REFRESH". To achieve this, the AT command interface of SAT, i.e. Remote-SAT, needs to be activated. An overview is given at Chapter 16., [SIM Application Toolkit \(SAT\) Commands](#), additional information is available with the document "Remote-SAT User Guide" [5].

14.1 AT+CRSM Restricted SIM Access

[AT+CRSM](#) offers easy access of the Elementary Files on the SIM. Access to the SIM database is restricted to the commands which are listed at [<command>](#). However, additional SIM commands are available via [AT^SXSM](#). All parameters of [AT+CRSM](#) are used as specified by GSM 11.11 [24]. TC65 handles internally all required SIM interface locking and file selection routines.

As response to the command, the TC65 sends the actual SIM information parameters and response data. Error result code "+CME ERROR" may be returned if the command cannot be passed to the SIM, e.g. if the SIM is not inserted. However, failure in the execution of the command in the SIM is reported in [<sw1>](#) and [<sw2>](#) parameters.

[AT+CRSM](#) requires PIN authentication. However, using [<command>](#) "READ BINARY" and [<command>](#) "READ RECORD" is possible before PIN authentication and if the SIM is blocked (state after three failed PIN authentication attempts) to access the contents of the following Elementary Files:

EF Symbol	EF Name	EF ID (hex.)	EF ID (dec.)
EF _{ICCID}	ICC identification	2FE2	12258
EF _{ELP}	Extended language preference	2F05	12037
EF _{LP}	Language preference	6F05	28421
EF _{SPN}	Service provider name	6F46	28486
EF _{AD}	Administrative data	6FAD	28589
EF _{Phase}	Phase identification	6FAE	28590
EF _{ECC}	Emergency call codes	6FB7	28599

Please beware of *possible changes to Elementary Files* by the network at any time, refer Chapter 14., [SIM related Commands](#).

Syntax

```
Test Command
AT+CRSM=?
Response(s)
OK
```

```
Write Command
AT+CRSM=<command>[, <fileID>[, <P1>, <P2>, <P3>[, <data>]]]
Response(s)
+CRSM: <sw1>,<sw2>[,<response>]
OK
ERROR
+CME ERROR: <err>
```

Reference(s)

GSM 07.07

PIN ASC0 ASC1 USB MUX1 MUX2 MUX3 Charge → Last

Parameter Description

<command>^(num)

SIM command number.

176	READ BINARY
178	READ RECORD
192	GET RESPONSE
214	UPDATE BINARY
220	UPDATE RECORD
242	STATUS

<fileID>^(num)

Identifier for an elementary data file on SIM, if used by [<command>](#).

<P1>^(num)

Parameter to be passed on by the TC65 to the SIM.

0...255

<P2>^(num)

Parameter to be passed on by the TC65 to the SIM.

0...255

<P3>^(num)

Parameter to be passed on by the TC65 to the SIM.

0...255

<data>^(str)

Information which shall be written to the SIM (hexadecimal character format).

<sw1>^(num)

Status information from the SIM about the execution of the actual command. It is returned in both cases, on successful or failed execution of the command.

0...255

<sw2>^(num)

Status information from the SIM about the execution of the actual command. It is returned in both cases, on successful or failed execution of the command.

0...255

<response>^(str)

Response data in case of a successful completion of the previously issued command. "STATUS" and "GET RESPONSE" commands return data, which gives information about the currently selected elementary data field. This information includes the type of file and its size.

After "READ BINARY" or "READ RECORD" commands the requested data will be returned.

<response> is empty after "UPDATE BINARY" or "UPDATE RECORD" commands.

14.2 AT^SXSM Extended SIM Access

AT^SXSM extends AT+CRSM with additional SIM commands.

All parameters of AT^SXSM are used as specified by GSM 11.11 [24]. TC65 handles internally all required SIM interface locking and file selection routines.

TC65 may return error result code "+CME ERROR" if the command cannot be passed to the SIM, e.g. if no SIM is inserted. However, errors related to SIM action are reported in <sw1> and <sw2> parameters as defined in GSM 11.11 [24].

Syntax

```

Test Command
AT^SXSM=?
Response(s)
OK

Write Command
AT^SXSM=<command>[, <fileID>[, <P1>, <P2>, <P3>[, <data>]]]
Response(s)
^SXSM: <sw1>, <sw2>[,<response>]
OK
ERROR
+CME ERROR: <err>
    
```



Parameter Description

<command> ^(num)	136 RUN GSM ALGORITHM Start the authentication mechanism and cipher key generation on the SIM. It runs the algorithms A3 and A8 using a 16 byte random number and the subscriber authentication key Ki, which is stored in the SIM.
<fileID> ^(num)	Identifier for an elementary data file on SIM, if used by <command>.
<P1> ^(num)	Parameter to be passed on by the TC65 to the SIM.
<P2> ^(num)	Parameter to be passed on by the TC65 to the SIM.
<P3> ^(num)	Parameter to be passed on by the TC65 to the SIM.
<data> ^(str)	If <command>=136 (RUN GSM ALGORITHM): 16 byte random number.

<sw1>^(num)

Status information from the SIM about the execution of the actual command. It is returned in both cases, on successful or failed execution of the command.

0...255

<sw2>^(num)

Status information from the SIM about the execution of the actual command. It is returned in both cases, on successful or failed execution of the command.

0...255

<response>^(str)

Response in case of a successful completion of the previously issued SIM command.

If <command>=136 (RUN GSM ALGORITHM):
TC65 returns SRES and cipher key Kc as calculated by the SIM.

Byte(s)	Description	Length
1 - 4	SRES - Signed RESponse	4
5 - 12	Kc - Cipher Key	8

Example

Use <command>=136 (RUN GSM ALGORITHM) to obtain SRES and cipher key Kc values as calculated by the SIM.

```
at^sxsm=136,,0,0,16,"00112233445566778899AABBCCDDEEFF" Start SIM command "RUN GSM ALGORITHM" with 16 byte random
^SXSM: SRES (bytes 1-4) and Cypher Key Kc (bytes 5-12) values as returned
144,0,00112233445566778899AA by the SIM.
BB
OK
```

14.3 AT^SCKS Query SIM and Chip Card Holder Status

This command controls the SIM connection presentation mode and queries the connection status of the SIM and the card holder tray of the TC65.

The query can be used for the locally attached and remote SIM's as well. For details regarding Remote SIM Access refer to [AT^SRSA](#).

Syntax

<p>Test Command</p> <pre>AT^SCKS=?</pre> <p>Response(s)</p> <pre>^SCKS: (list of supported <mode>s) OK</pre>	
<p>Read Command</p> <pre>AT^SCKS?</pre> <p>Response(s)</p> <pre>^SCKS: <mode>, <SimStatus> OK ERROR +CME ERROR: <err></pre>	
<p>Write Command</p> <pre>AT^SCKS=<mode></pre> <p>Response(s)</p> <pre>OK ERROR +CME ERROR: <err></pre>	
<p>Reference(s)</p> <p>SIEMENS</p>	

Unsolicited Result Code

`^SCKS: <SimStatus>`

During startup, and if the TC65's SIM connection status has changed an unsolicited result code (URC) is issued.

Command Description

The read command returns the URC presentation mode and the status of the SIM card connection.

The write command enables or disables the presentation of URCs to report whether or not the SIM card is connected.

If the ME is powered down or reset ([AT+CFUN](#) or [AT^SMSO](#)) the current presentation mode setting `<mode>` will not be retained. Therefore the setting `<mode>=1` needs to be restored after power on the TC65 or may be saved in the user profile ([AT&W](#)).

Parameter Description

<code><mode></code> ^{(num)(&W)(&V)}	
0(&F)	Suppress unsolicited result codes
1	Output unsolicited result codes

<SimStatus>(num)&V

0	Card holder tray removed or SIM connection error
1	SIM inserted(refer to note)
2	The SIM interface HW has been deactivated to prevent possible damage (e.g. if a SIM with invalid or unsupported electrical specifications has been detected). The SIM interface can be reactivated only with a restart of the module, e.g. with "AT+CFUN= n,1". If the Remote SIM Access feature is activated (refer to AT^SRSA) and a SIM card error occurs while accessing the remote SIM, the TC65 switches to its local SIM, if any. If the SIM card error occurs while local SIM access, use of the remote SIM is still possible.

Note

- <SimStatus> reflects the status of the SIM and the card holder tray. Therefore if an empty SIM card tray is inserted, two URCs will be presented, indicating the status 1 followed by 0, i.e. a SIM is inserted into the card holder tray but no SIM connection could be established.
If Remote SIM Access switches back from remote to local SIM, SCKS indicates the status 1 regardless of the real SIM status. If no SIM is inserted this is followed by a second SCKS URC indicating 0.

Example

AT^SCKS=1	Activates the presentation of unsolicited result codes
OK	

Now, after inserting an empty card tray the following URCs appear:

^SCKS: 1	Tray connected
^SCKS: 0	No SIM card found

14.4 AT^SSET Indicate SIM data ready

After power on and personalization (PIN entry if required) the ME starts reading data from SIM. With this command it is possible to enable URC "**^SSIM READY**" indication on the corresponding serial channel when this process has been completed. Afterwards all commands that depends on SIM data fields can be used, e.g. the SMS and phone book commands.

[AT^SSET](#) setting is storable via [AT+W](#).

Syntax

<p>Test Command</p> <pre>AT^SSET=?</pre> <p>Response(s)</p> <pre>^SSET:(list of supported <n>s) OK</pre>	
<p>Read Command</p> <pre>AT^SSET?</pre> <p>Response(s)</p> <pre>^SSET: <n> OK ERROR +CME ERROR: <err></pre>	
<p>Write Command</p> <pre>AT^SSET=[<n>]</pre> <p>Response(s)</p> <pre>OK ERROR +CME ERROR: <err></pre>	
<p>Reference(s)</p> <p>SIEMENS</p>	

Unsolicited Result Code

^SSIM READY

The URC acknowledges to the user that SIM data is accessible. Before that, any attempt to access one of the phonebooks, view SMS or access SIM data will result in "+CME ERROR: 14" (SIM busy).

Parameter Description

<n> ^{(num)(&W)(&V)}	
SIM ready presentation mode	
0 ^(&F)	disable URC " ^SSIM READY " indication.
1	enable URC " ^SSIM READY " indication.

14.5 AT^SCID Display SIM card identification number

Syntax

Test Command	
AT^SCID=?	
Response(s)	
OK	
Exec Command	
AT^SCID	
Response(s)	
^SCID: <cid>	
OK	
ERROR	
+CME ERROR: <err>	
Reference(s)	
SIEMENS	



Command Description

TA returns the card identification number in SIM (SIM file EF_{ICCID}, see GSM 11.11 Chap.10.1.1) as string type.

Parameter Description

<cid> ^(str)
card identification number of SIM card

14.6 AT+CXXCID Display card ID

Syntax

Test Command	
AT+CXXCID=?	
Response(s)	
OK	
Exec Command	
AT+CXXCID	
Response(s)	
+CXXCID: <cid>	
OK	
ERROR	
+CME ERROR: <err>	
Reference(s)	
SIEMENS	



Command Description

TA returns the card identification number in SIM (SIM file EF ICCID, see GSM 11.11 Chap.10.1.1) as string type.

Note

- See also: [AT^SCID](#).

15. Remote SIM Access (RSA) Commands

This chapter contains the reference of AT commands and responses related to the Remote SIM Access (RSA) feature of the Cellular Engine TC65.

RSA allows the TC65 to use a SIM card via its serial interface additionally to the SIM which is locally attached via the dedicated lines on the interface connector.

For further details contact the Wireless Modules Application Engineering Department at Siemens AG.

Figure 15.1, [Basic Remote SIM Access Usage Scenario](#) illustrates a possible RSA use case:

- The TC65 is built in a car as part of and controlled by a Car Application, e.g. a telematic or telemetry system.
- If a car driver enters his car he connects his cell phone with the Car Application. This can be done via a car cradle or a wireless link.

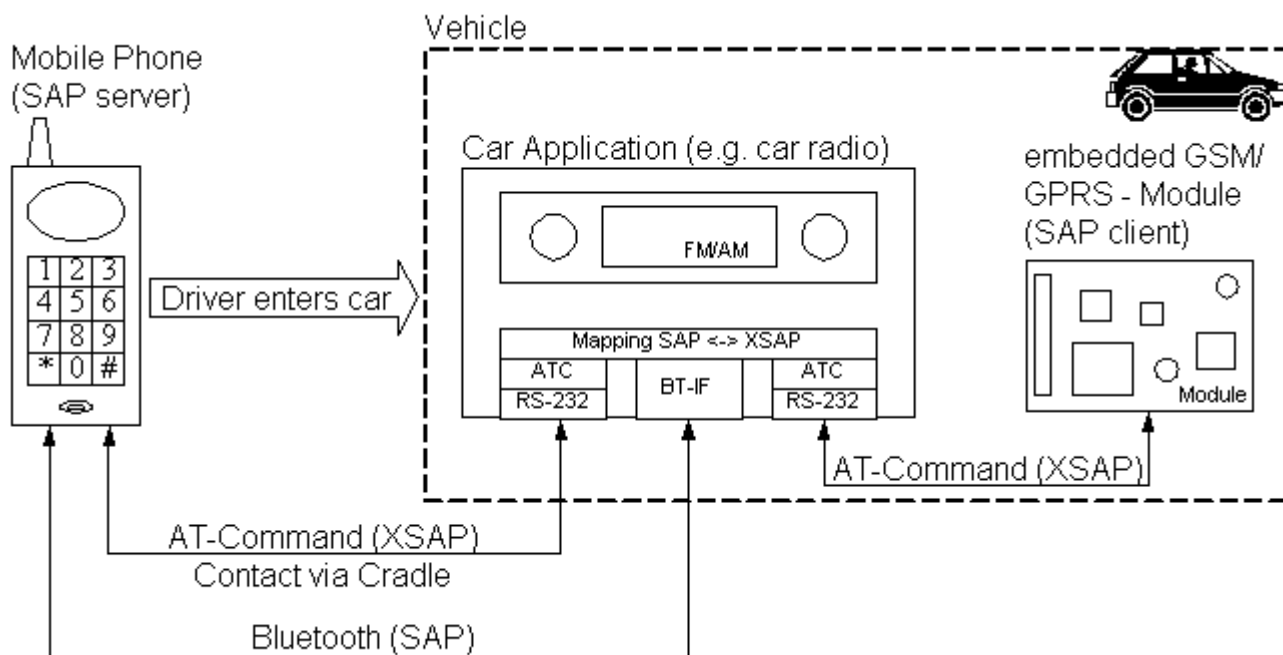

Figure 15.1: Basic Remote SIM Access Usage Scenario

The necessary protocols and procedures are implemented following the «SIM Access Profile Interoperability Specification» [13].

As stated there, with this profile the user can personalize his/her car-embedded phone with a SIM card in an external device, which is connected via a wireless link. The external device can either be a simple SIM card holder or a portable phone, which is brought into the car.

The SIM Access Profile builds on the interface between the telephone and a SIM card, refer to the «Specification of the Subscriber Identity Module (GSM 11.11)» [24].

Since the TC65 itself does not control a Bluetooth wireless link, the SIM communication is routed via a serial channel. It's up to an external application to map this data to any suitable communication path, e.g. a car cradle or a Bluetooth modem as the SIEMOS Bluetooth-Module offered by Siemens AG.

In general, the ME can operate either as SAP server or as SAP client. A brief description of the configuration is given below.

- SAP Server

The SIM Access Server has direct (galvanic) access to a SIM. It acts as a SIM card reader, which assists the client in accessing and controlling the SIM via the serial link. Typical examples of a server are SIM card reader or cellular phones which are integrated in a car environment.

After SAP client activation (see (1) in Figure 15.2, SIM usage states of SAP server) the ME starts sending the SAP message CONNECTION_REQ. However, the client will still use its local SIM card until a server responds and the parameter negotiation with subsequent ATR access has been accomplished successfully.

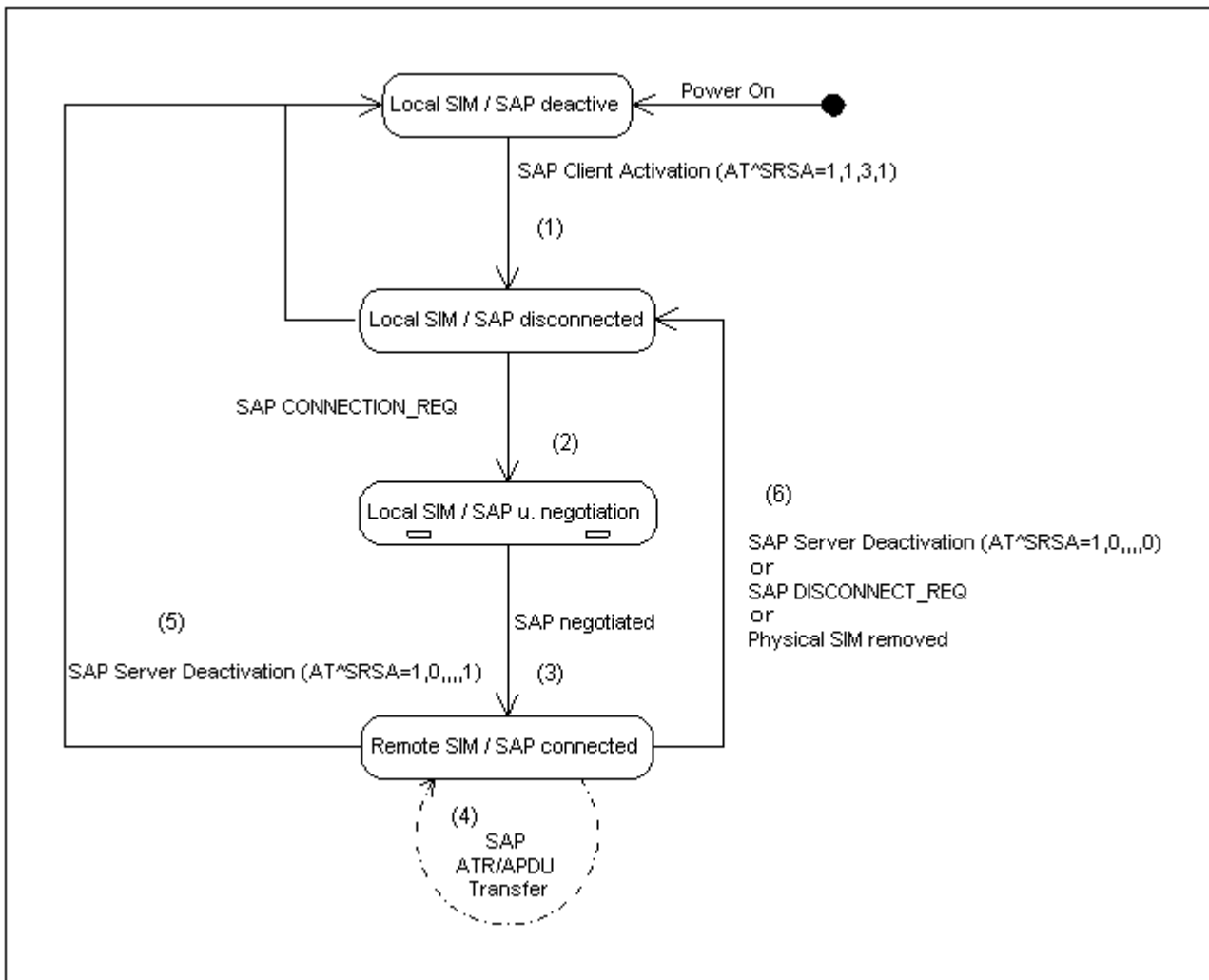

Figure 15.2: SIM usage states of SAP server

- SAP Client**
 The SIM Access Client is connected via a serial link to the SIM Access Server. The client accesses and controls the SIM inside the Server via the serial link. Typical examples of a server are a simple SIM card holder or a portable phone in the car environment. A typical example of a client is a car phone, which uses a SIM card in the server for a connection to the cellular network. With the additional AT Commands it is possible to switch the TC65 to use an external SIM instead of the physically attached (local) SIM during runtime. After SAP server activation (see (1) in Figure 15.3, SIM usage states of SAP client) the ME waits for the SAP message CONNECTION_REQ. The server will use its local SIM until the parameter negotiation has been accomplished successfully.

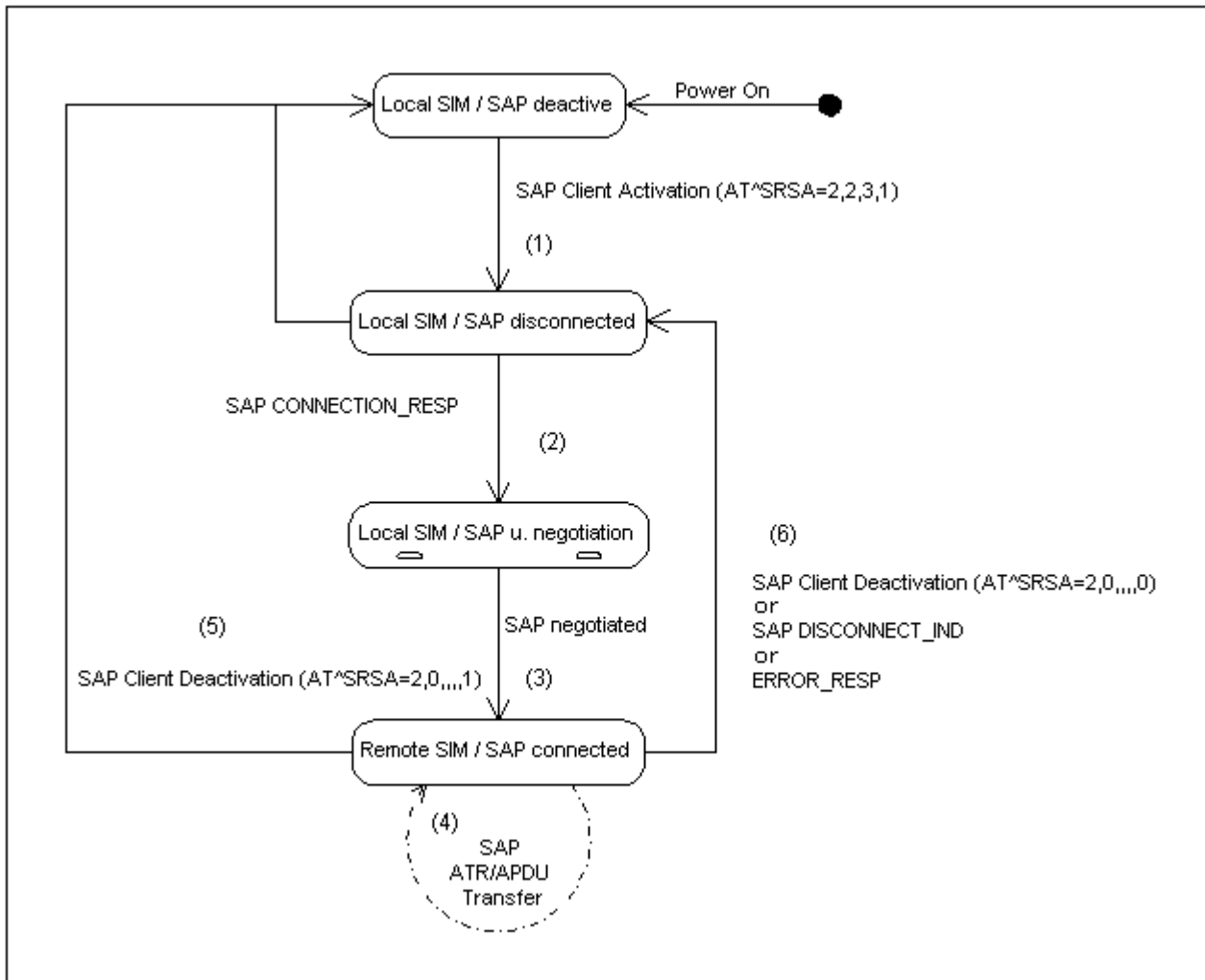

Figure 15.3: SIM usage states of SAP client

15.1 AT^SRSA Remote SIM Access Activation

Syntax

Test Command

AT^SRSA=?

Response(s)

^SRSA: (list of supported <devId>s) , (list of supported <sapRole>s) , (list of supported <muxChan>s) , (list of supported <dataForm>s) , (list of supported <beaconPer>s) , (list of supported <discType>s)

OK

<p>Read Command</p> <p>AT^SRSA?</p> <p>Response(s)</p> <p>[^SRSA:<devId>, <sapRole>, <connState>, <muxChan>, <dataForm>, <beaconPer>] OK</p>	<p>Write Command</p> <p>AT^SRSA=<devId>, <sapRole>[, <muxChan>[, <dataForm>[, <beaconPer>[, <discType>]]]]</p> <p>Response(s)</p> <p>^SRSA:<actResult> OK</p>
<p>Reference(s)</p> <p>SIEMENS</p>	<p>PIN ASC0 ASC1 USB MUX1 MUX2 MUX3 Charge → Last</p> <p><input type="radio"/> <input checked="" type="radio"/> <input checked="" type="radio"/> <input checked="" type="radio"/> <input checked="" type="radio"/> <input checked="" type="radio"/> <input checked="" type="radio"/> <input checked="" type="radio"/> <input type="radio"/> <input checked="" type="radio"/> <input type="radio"/></p>

Unsolicited Result Code

^SRSA: <devId>, <sapRole>, <connState>

This URC is generated if either the SIM usage scheme or the SAP connection status has changed due to SAP message communication or AT command control.

Command Description

The read command can be used to request the current RSA settings. Every line outputs an RSA connection, if any.

The write command allows to control the TC65's SIM usage scheme along with the related configuration parameters.

Parameter Description

<actResult> ^(num)	
Activation result	
0	No Error Parameters valid, SAP mode change initiated. However, actual mode change is signaled via URC " ^SRSA ". Other values indicate invalid activation requests, no SAP mode change is initiated in the following cases:
1	Error unspecified.
2	Error activation command is busy.
3	Error activation started with serial multiplex mode is off.
4	Error activation started on invalid serial multiplex channel.
5	Error device Id is already known.
6	Error SAP mode is already active.
7	Error invalid parameter.

<devId> ^(num)	
Device identification	
Arbitrary number assigned on RSA activation by the host. Used for all subsequent RSA communication (AT commands and URCs) during the activated session. Different numbers shall be used for SAP server and client. 1...100	

<sapRole>^(num)

SIM usage scheme of the TC65

Direct switch from SAP server to SAP client mode and vice versa is not supported.

- | | |
|------------------|--|
| 0 ^(P) | Local SIM
If this parameter value is used with write command meaning depends on parameter <discType>. |
| 1 | SAP server
Enable Remote SIM Access usage whereas the TC65 acts as SIM Access server. It waits for a SAP message CONNECT_REQ to deregister from the network and then acts as a SIM card reader. However, under the following conditions the TC65 will not react to CONNECT_REQ messages: <ul style="list-style-type: none">• During any calls (voice or data),• if a GPRS context is activated,• if Remote-SAT interface is activated (AT^SSTA) and a proactive command is ongoing. |
| 2 | SAP client
Enable Remote SIM Access usage whereas the TC65 acts as SIM Access client. It starts sending CONNECT_REQ messages periodically, refer to parameter <beaconPer>. Under the same conditions listed above the TC65 will neither send CONNECT_REQ messages nor a SIM switch will take place. The client deregisters from the network if a local SIM was used before and switches to a remote SIM when <ul style="list-style-type: none">• SAP message CONNECT_RESP is received,• SAP message STATUS_IND is received,• SAP message ATR_RESP is received after the appropriate request was issued by the client. |

<muxChan>^(num)

Serial multiplexer channel number

Logical channels 2 and 3 can be reserved for RSA traffic on serial interface multiplexer. Multiplex mode shall be enabled before RSA activation via [AT+CMUX](#).

Note:

Number of multiplex channels is implementation specific, please refer to [AT+CMUX](#) and multiplex documentation supplied with the TC65. If for instance three logical channels are implemented these are referenced as numbers 1 - 3. The selected multiplexer channel is dedicated to RSA communication. However, it is not possible to reserve logical channel number 1 for RSA traffic because only on this channel the TC65 can perform circuit switched data transfer, e.g. FAX or data calls.

<dataForm>^(num)

SAP message data format

- | | |
|-----|---|
| [0] | XSAP ATC/URC format
SAP messages are translated into ASCII coded strings and transmitted as parameters of AT command AT^SRSM and URC " ^SRSM ". If using a Bluetooth modem with AT command interface for transmitting data, it is recommended to choose the XSAP data format. Note that AT commands not related to RSA shall not be used after RSA activation on the dedicated serial multiplexer channel. |
|-----|---|

1 SAP transparent binary format
SAP messages are transmitted as coded in the SAP specification. This data format should be selected for transmitting SIM data to a Bluetooth stack which is part of the application. The binary data will be exchanged transparently with the ME. However, the SAP data format does not need ASCII character conversation. As a result less data will be transferred and the SIM communication will be faster.

`<beaconPer>`^(num)

Beacon period

Determines the period in seconds between sending the CONNECT_REQ messages. A 0 value leads to a one-time connection request. This parameter is applicable for SAP client activation only.

0...[6]...100

`<discType>`^(num)

SAP disconnection type

This parameter is only applicable if `<sapRole>` equals 0.

Calls or active GPRS contexts via a remote SIM will be lost due to missing SIM access. Use of AT+CLCC is recommended to query call states before RSA deactivation.

0 Hold SAP role
SAP connection is going to be disabled. The TC65 remains in SAP mode and is ready to (re)establish a SAP connection. If a SAP connection was ongoing an URC "`^SRSA: <devId>, <sapRole>, <connState>`" with `<connState>= 0` is issued.

- A server exclusively sends a SAP message DISCONNECT_IND (type "Graceful") to the client.
- A client saves SIM data which is temporarily held in TC65's memory to the remote SIM and sends SAP message DISCONNECT_REQ to the server. If requested the client restarts sending CONNECTION_REQ messages. If a local SIM is attached the TC65 will use it to register to the network until a server offers its SIM again.

[1] Stop SAP operation
SAP connection is disabled and TC65 is forced to local SIM mode. An URC "`^SRSA: <devId>, <sapRole>, <connState>`" with `<sapRole>= 0` and `<connState>= 0` is issued.

- A server sends a SAP message DISCONNECT_IND (type "Immediate") to the client and returns to local SIM mode immediately. SIM data which is temporarily held in client's memory would be lost.
- A client exclusively sends SAP message DISCONNECT_REQ to the server. Without saving temporary held data to a remote SIM or waiting for DISCONNECT_RESP the client returns to local SIM mode immediately.

`<connState>`^(num)

SAP connection state

0 No SAP connection established.

1 SAP connection ongoing, i.e. peers exchange messages.

Notes

- If AT^SRSA with `<dataForm>` set to 1 (SAP) is given on the same serial multiplex channel as specified with parameter `<muxChan>` the SAP data transfer mode is entered immediately. Therefore no command response is issued by the TC65 in this case.

- If the TC65 is acting as SAP client and has switched to a remote SIM it starts accessing this SIM. If during this time AT commands are used which need access to the SIM itself (e.g. [AT+CPIN?](#)) the TC65 responds with "+CME ERROR: SIM blocked" or "+CME ERROR: SIM busy". Retry until SIM is fully accessible in this case.
- If the TC65 is acting as SAP server and has released its SIM to a client it considers it as not accessible. Therefore AT commands which require SIM access will be rejected with "+CME ERROR: SIM not inserted".
- Parameters [<muxChan>](#), [<dataForm>](#) and [<beaconPer>](#) are applicable for RSA activation only.

15.2 AT^SRSM Remote SIM Access Message

This command is used to transfer SAP messages between devices acting as SAP server and client. It is applicable for XSAP data format only, for details please refer to parameter `<dataForm>` of command `AT^SRSA`. The write command transports SAP messages into an ME acting as SAP server or client.

Syntax

Test Command	
AT^SRSM=?	
Response(s)	
OK	
Write Command	
AT^SRSM=<RsaDevId>, <RsaMsgId>[, <RsaMsgData>[, <RsaMsgLen>[, <RsaMsgRc>]]]	
Response(s)	
OK	
Reference(s)	
SIEMENS	

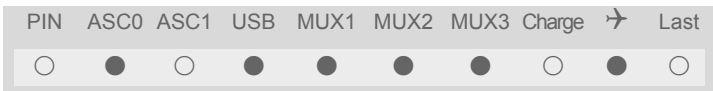

Unsolicited Result Code

`^SRSM: <RsaDevId>, <RsaMsgId>[, <RsaMsgData>[, <RsaMsgLen>[, <RsaMsgRc>]]]`

This URC is issued by an ME acting as SAP server or client to transfer SAP message data.

Parameter Description

<code><RsaDevId></code> ^(num)
RSA device identification Number assigned by the host on RSA activation via <code>AT^SRSA</code> , parameter <code><devId></code> .
<code><RsaMsgId></code> ^(num)
RSA message identification For details refer to Section 15.2.1, SAP Request Message Parameter and Section 15.2.2, SAP Response Message Parameter .
<code><RsaMsgData></code> ^(str)
RSA message data For details refer to Section 15.2.1, SAP Request Message Parameter and Section 15.2.2, SAP Response Message Parameter .
<code><RsaMsgLen></code> ^(num)
RSA message data length For details refer to Section 15.2.1, SAP Request Message Parameter and Section 15.2.2, SAP Response Message Parameter .
<code><RsaMsgRc></code> ^(num)
RSA message result code For details refer to Section 15.2.1, SAP Request Message Parameter and Section 15.2.2, SAP Response Message Parameter .

<MaxMsgSize>^(num)

SAP parameter MaxMsgSize

Handling of this parameter is as follows:

- If the TC65 is acting as SAP client the requested value of <MaxMsgSize> is 300. While SAP connection setup this value may be negotiated with the server to the minimal value 274, which is calculated by 256 data bytes as part of a TRANSFER_APDU_RESP message plus a 16 byte SAP header and two status bytes. If the server does not accept this value range no SAP connection will be established.
- If the TC65 is acting as SAP server it requires that a <MaxMsgSize> value of 276 will be accepted by a connected client.

<ConnStatus>^(num)

SAP parameter Connection Status

<DiscType>^(num)

SAP parameter Disconnection Type

<CmdApdu>^(str)

SAP parameter Command APDU

<CmdApduLen>^(num)

SAP parameter Command APDU length

<RspApdu>^(str)

SAP parameter Response APDU

<RspApduLen>^(num)

SAP parameter Response APDU length

<ATR>^(str)

SAP parameter ATR

<AttrLen>^(num)

SAP parameter ATR length

<ResCode>^(num)

SAP parameter Result Code

<CardRdStatus>^(num)

SAP parameter Card Reader Status

<StatusChange>^(num)

SAP parameter Status Change

Example

The following example shows how to establish a RSA connection.

AT+CMEE=2 OK	Switch on verbose error messages (use AT+CMEE=1 with production code)
AT+CREG=1 OK	Switch on network registration URC
AT^SSET=1 OK	Switch on SIM data ready URC
AT^SCKS=1 OK	Switch on SIM status URC
AT^SM20=0 OK	Switch on immediately. Return after attempting a call via ATD.
AT^SRSA? OK	Does the ME support RSA and is a SAP connection established?
AT^SRSA=2,2,3,0 ^SRSA:0 OK ^SRSA:2,2,0	Initialization of RSA mode using XSAP data format. URC indicating SAP client start without ongoing connection. ME now starts sending SAP message CONNECTION_REQ on dedicated RSA channel. If a SAP server has responded and offers its SIM: URC indicating a connection with SAP server URC indicating the loss of (local) SIM URC indicating the deregistration from network because of loss of SIM. URC indicating the activation of remote SIM ME now starts reading data from the SIM Does the new SIM require a PIN?
^SRSA:2,2,1 ^SCKS:0 +CREG:0 ^SCKS:1	
+CME ERROR: SIM blocked or +CME ERROR: SIM busy AT+CPIN? +CME ERROR: SIM PIN OK	Retry if the ME returns these messages Enter PIN
AT+CPIN=1234 OK +CREG:2 +CREG:1 ^SSIM READY ATD4917777777777777 OK	URC indicating network registration. URC indicating that SIM data is read out. Make a call.

15.2.1 SAP Request Message Parameter

The following table shows all SAP request message parameter that are used in two cases:

- An URC "**^SRSM**" is issued by an ME acting as SAP client, then
- an **AT^SRSM** write command transfers its data into an ME acting as SAP server.

SAP Request Message Parameter Mapping:

Id	SAP Message Name	SAP parameter mapping to AT^SRSA parameters <RsaMsgId> [,<RsaMsgData> [,<RsaMsgLen> [,<RsaMsgRc>]]]
0	CONNECT_REQ	0,,<MaxMsgSize>
2	DISCONNECT_REQ	2
5	TRANSFER_APDU_REQ	5,<CmdApdu>,<CmdApduLen>
7	TRANSFER_ATR_REQ	7
9	POWER_SIM_OFF_REQ	9
11	POWER_SIM_ON_REQ	11
13	RESET_SIM_REQ	13
15	TRANSFER_CARD_READER_STATUS_REQ	15

15.2.2 SAP Response Message Parameter

The following table shows all SAP response and indication message parameters that are used in two cases:

- An URC "**AT^SRSM**" is issued by an ME acting as SAP server, then
- an **AT^SRSM** write command transfers its data into an ME acting as SAP client.

SAP Response Message Parameter Mapping:

Id	SAP Message Name	SAP parameter mapping to AT^SRSA parameters <RsaMsgId> [,<RsaMsgData> [,<RsaMsgLen> [,<RsaMsgRc>]]]
1	CONNECT_RESP	1,,<MaxMsgSize>,<ConnStatus>
3	DISCONNECT_RESP	3
4	DISCONNECT_IND	4,,,<DiscType>
6	TRANSFER_APDU_RESP	6,<RspApdu>,<RspApduLen>,<ResCode>
8	TRANSFER_ATR_RESP	8,<ATR>,<AtrLen>,<ResCode>
10	POWER_SIM_OFF_RESP	10,,,<ResCode>
12	POWER_SIM_ON_RESP	12,,,<ResCode>
14	RESET_SIM_RESP	14,,,<ResCode>
16	TRANSFER_CARD_READER_STATUS_RESP	16,,<CardRdStatus>,<ResCode>
17	STATUS_IND	17,,,<StatusChange>
18	ERROR_RESP	18

15.3 Related AT Commands

The following commands might be of interest while using the RSA feature. For a detailed description of all commands given below refer to:

- [AT^SCKS](#)
This AT command is used to check the current status of the SIM (local or remote).
- [AT^SSET](#)
After power on and personalization (PIN entry if required), the ME starts reading data from the SIM. Please keep in mind that after entering the PIN, even after the TE sends "OK", subsequent commands need access to data stored on the SIM may be blocked for up to 30 seconds. It may take even longer to access the remote SIM depending on the establishment of the RSA communication link. Therefore, it is recommended that the [AT^SSET](#) command, which controls the "^SSIM READY" URC indicating that the SIM data reading process has been completed, be used. Afterwards all commands regarding to SIM data files can be used, e.g. the SMS and phonebook commands.
- [AT+CLCC](#)
This command is recommended for querying the state of current calls. A list of all active calls will be returned. This is especially important if the SAP connection should be terminated using [AT^SRSA=<devId>,<sapRole>,,,,<discType>](#); where [<sapRole>](#) is set to 0 and [<discType>](#) set to 1. All calls or active GPRS contexts established via remote SIM will be terminated and the ME will use the locally attached SIM card.
- SIM data storage
It is recommended that all user relevant data are stored on the SIM only. For example, added phonebook and SMS entries in the client's storage are not accessible after a RSA connection.

15.3.1 Establishing an RSA connection in a PC environment

To set up an RSA connection in a PC environment an appropriate PC application is needed. For test and evaluation purposes and as exemplary implementation guidance Siemens offers a PC application called "ComBridge" as MS Windows executable and source code. For ordering details contact your local Siemens dealer or visit the Siemens website. "ComBridge" provides basic features to generate a car application environment, e.g. mapping of the SAP communication between a SAP server and client. To support the different RSA coding modes (SAP and XSAP) and to transfer data between the two COM ports, the PC application uses two variable modules (filters):

- XSAP filter Translating the "^SRSM" URCs into AT command "AT^SRSM"
- SAP filter Transparently transfer binary SAP messages. The generic "1:1" filter ("software null modem") can also be used for this purpose, but communication might be slower since it performs bitwise data transfer.

15.3.2 Car cradle scenario (XSAP)

This example describes the connection of two cellular engines. It is recommended that the instructions be followed in the order that they are presented:

- Install two WinMux drivers on the PC and connect each ME to the physical port of a Multiplexer.
- Connect the PC application "ComBridge" to one virtual COM port of each Multiplexer. This establishes an communication link between the two cellular engines. Bear in mind that AT commands can still be issued on both cellular engines using the remaining serial channels.
- Select the "ComBridge" XSAP filter.
- Open the XSAP "Config Filter" menu and deactivate the "Startup - Send Initialization" and the "Shutdown - Switch back to local SIM" tags. However, the appropriate device IDs need to be entered in the "Startup" frame.
- Press the "ComBridge - start" button to connect both MEs.
- Start the SAP client via AT command "AT^SRSA=2,2,3,0", if multiplexer channel 3 is used.
- Start the SAP server via AT command "AT^SRSA=1,1,3,0", if multiplexer channel 3 is used.

15.3.3 Bluetooth scenario (SAP)

A connection between a cellular engine operating as a SAP client and an ME that supports Bluetooth and SIM Access profile requires:

a) System requirements

- Windows 2000, Windows XP (or later) installed
- USB Bluetooth dongle. It is recommended to use the Fujitsu-Siemens product with the "PlugFree" Bluetooth driver. This driver allows connections to Bluetooth profiles which are not yet specified by the SIG, e.g. SAP.

b) Installation procedure

- After installing the USB Bluetooth dongle and the "PlugFree" driver software, the Bluetooth profiles are accessible via their own virtual COM port.
- If the WinMux driver has been installed another three virtual channels (mapped to additional COM ports) are available. The physical Multiplexer COM port is connected to the cellular engine.
- Start the Bluetooth connection using the driver provided by the USB Bluetooth dongle.
- Through "ComBridge", one virtual COM port supplied by "WinMux" is connected to the SAP COM port of "PlugFree". This establishes a direct communication link between the cellular engine and the cellular phone. However, AT commands can still be entered to the cellular engine via the remaining multiplexer channels.
- Select the "ComBridge" SAP filter.
- Press the "ComBridge-Start" button to connect both MEs.
- Start the SAP client using the AT command "AT^SRSA=2,2,3,1", if multiplexer channel 3 is used.

16. SIM Application Toolkit (SAT) Commands

This chapter offers a brief reference of commands and responses related to the TC65's SIM Application Toolkit (SAT) implementation. Detailed information is available with the document "Remote-SAT User Guide" [5]. Please contact the Wireless Modules Application Engineering Department at Siemens AG for details.

ETSI specification GSM 11.14 [25] defines SAT in detail.

SAT allows for the execution of applications provided by a Subscriber Identity Module (SIM). Usually SIM cards are used for storing GSM network provider and user specific data, e.g. phonebook entries and Short Messages (SMS). However, a SIM card may also hold a SIM Application.

Since the TC65 has SAT functionality it is able to execute the commands issued by applications implemented on a network provider specific SIM card.

Two groups of commands are used between the ME and the SIM Application:

- Proactive Commands are issued to the TC65's SAT from the SIM Application, such as "DISPLAY TEXT".
- Envelope Commands are responded to the SIM Application from the TC65, such as "MENU SELECTION".

16.1 AT^SSTA SAT Interface Activation

Syntax

Test Command AT^SSTA=? Response(s) ^SSTA: (list of supported <state>s), (list of supported <Alphabet>s) OK	
Read Command AT^SSTA? Response(s) ^SSTA: <state>, <Alphabet>, <allowedInstance>, <SatProfile> OK	
Write Command AT^SSTA=<mode>[, <Alphabet>] Response(s) OK	
Reference(s) SIEMENS	PIN ASC0 ASC1 USB MUX1 MUX2 MUX3 Charge → Last <input type="radio"/> <input checked="" type="radio"/> <input checked="" type="radio"/> <input checked="" type="radio"/> <input checked="" type="radio"/> <input checked="" type="radio"/> <input checked="" type="radio"/> <input type="radio"/> <input type="radio"/>

Command Description

The read command can be used to request the current operating status and the used alphabet of the Remote-SAT interface.

The write command is used to activate the AT command interface of the SIM Application Toolkit in the TC65 and needs to be issued after every power on. However, removing and inserting the SIM does not affect the activation status.

SAT commands which are not using the AT interface (non MMI related SAT commands , e.g. PROVIDE LOCAL INFORMATION) could be executed without activating Remote-SAT.

Parameter Description

<state>^(num)

TC65 Remote-SAT interface states

0	RESET
1	OFF
2	IDLE
3	PAC
4	WAIT

<Alphabet>^(num)

0	GSM character set Input of a character requests one byte, e.g. "Y".
1	UCS2 To display the 16 bit value of characters represented in UCS2 alphabet a 4 byte string is required, e.g. "0059" is coding the character "Y". For details please refer to ISO/IEC 10646.

<allowedInstance>^(num)

0	SAT is already used on another instance (logical channel in case of the multiplex protocol). Only test and read commands can be used.
1	SAT may be started on this instance via the write version of this command.

<SatProfile>^(str)

SAT profile according to GSM 11.14 [25].
The profile tells the SIM Application which features (e.g. proactive commands) are supported by the SIM Application Toolkit implementation of the TC65.

<mode>^(num)

1	Activate Remote-SAT
---	---------------------

Note

- To limit the time Remote-SAT is kept in states PAC or WAIT any ongoing (but unanswered) Proactive Command is automatically aborted after 10 minutes with Terminal Response "ME currently unable to process command" or "No response from user" if applicable. An URC "Terminate Proactive Command" will be send to the external application in this case, too.

16.2 ^SSTN SAT Notification

Unsolicited Result Codes

URC 1

Proactive Command notification

^SSTN: `<cmdType>`

Every time the SIM Application issues a Proactive Command, via the ME, the TA will receive a notification. This indicates the type of Proactive Command issued.

`AT^SSTGI` must then be used by the TA to request the parameters of the Proactive Command from the ME. Upon receiving the ^SSTGI response from the ME, the TA must send `AT^SSTR` to confirm the execution of the Proactive Command and provide any required user response, e.g. a selected menu item.

URC 2

Terminate Proactive Command notification

^SSTN: `<cmdTerminateValue>`

When the SIM application has issued a Proactive Command to the ME, it is possible that this command will be terminated later. URC "`^SSTN`" is sent with a different Proactive Command type number (added terminate offset 100) to indicate the termination of the specified command.

The state changes to idle. Therefore the TA should avoid sending any further commands related to the terminated Proactive Command, e.g. `AT^SSTGI` or `AT^SSTR`.

URC 3

Notification that SIM Application has returned to main menu

^SSTN: 254

Notification to the TA when the SIM Application has finished a command cycle and again enters its main menu, which was transferred with an URC "`^SSTN: 37`" (SET UP MENU) at start up.

This URC should be used to open this menu on the screen.

The TA does not need to respond directly, i.e. `AT^SSTR` is not required.

URC 4

SIM reset notification

^SSTN: 255

Notification to the TA if a Proactive Command "REFRESH - SIM Reset" has been issued by the SIM Application, please refer to `AT^SSTGI`.

This URC should be used to set the TAs application to its initial state since the SIM Application will start from the beginning, too.

The TA does not need to respond directly, i.e. related `AT^SSTGI` and `AT^SSTR` are neither required nor allowed.

Since the ME is still busy on SIM access the ME may respond with "+CME ERROR: SIM blocked" or "+CME ERROR: SIM busy" on following PIN required AT Commands for a while. Then TA shall retry until the ME responds with "OK". The time needed for this process depends on the SIM and may take more than 10 seconds.

Parameter Description

`<cmdType>`^(num)

Proactive Command number

`<cmdTerminateValue>`^(num)

Defined as `<cmdType>` + terminate offset. The terminate offset equals 100.

16.3 AT^SSTGI SAT Get Information

Regularly this command is used upon receipt of an URC "[^SSTN](#)" to request the parameters of the Proactive Command.

Then the TA is expected to acknowledge the [AT^SSTGI](#) response with [AT^SSTR](#) to confirm that the Proactive Command has been executed. [AT^SSTR](#) will also provide any user information, e.g. a selected menu item. The Proactive Command type value specifies to which "[^SSTN](#)" the command is related.

Syntax

<p>Test Command</p> <p>AT^SSTGI=?</p> <p>Response(s)</p> <p>^SSTGI : (list of supported <state>s), (list of supported <cmdType>s)</p> <p>OK</p>	
<p>Read Command</p> <p>AT^SSTGI?</p> <p>Response(s)</p> <p>^SSTGI : <state>, <cmdType></p> <p>OK</p>	
<p>Write Command</p> <p>AT^SSTGI=<cmdType></p> <p>Response(s)</p> <p>OK</p>	
<p>Reference(s)</p> <p>SIEMENS</p>	<p>PIN ASC0 ASC1 USB MUX1 MUX2 MUX3 Charge  Last</p> <p><input type="radio"/> <input checked="" type="radio"/> <input checked="" type="radio"/> <input checked="" type="radio"/> <input checked="" type="radio"/> <input checked="" type="radio"/> <input checked="" type="radio"/> <input checked="" type="radio"/> <input type="radio"/> <input checked="" type="radio"/> <input type="radio"/></p>

Parameter Description

[<state>](#)^(num)

TC65 Remote-SAT interface states

0	RESET
1	OFF
2	IDLE
3	PAC
4	WAIT

[<cmdType>](#)^(num)

Related Proactive Command

16.4 AT^SSTR SAT Response

The TA is expected to acknowledge the AT^SSTGI response with AT^SSTR to confirm that the Proactive Command has been executed. AT^SSTR will also provide any user information, e.g. a selected menu item.

Syntax

<p>Test Command</p> <p>AT^SSTR=?</p> <p>Response(s)</p> <p>^SSTR: (list of supported <state>s), (list of supported <cmdType>s)</p> <p>OK</p>	
<p>Read Command</p> <p>AT^SSTR?</p> <p>Response(s)</p> <p>^SSTR: <state>, <cmdType></p> <p>OK</p>	
<p>Write Command</p> <p>AT^SSTR=<cmdType>, <status>[, <inputNumber>][, <inputString>]</p> <p>Response(s)</p> <p>OK</p>	
<p>Reference(s)</p> <p>SIEMENS</p>	

Parameter Description

<state>^(num)

TC65 Remote-SAT interface states

0	RESET
1	OFF
2	IDLE
3	PAC
4	WAIT

<cmdType>^(num)

Number related to Proactive Command or event type according to GSM 11.14 [25].

<status>^(num)

Command status return regarding the type of action that has taken place, e.g. action performed by the user. Values are in accordance with GSM 11.14 [25].

<inputNumber>^(num)

Response number entered by user

<inputString>^(str)

Response string entered by user

17. Phonebook Commands

The AT commands described in this chapter allow the external application to access the phonebooks located in the TC65's memory or on the attached Subscriber Identity Module (SIM).

17.1 Sort Order for Phonebooks

Due to the support of UCS2 for the `<text>` part of phonebook entries, the sort order for phonebook records follows the algorithm published as Unicode Technical Standard #10, "Unicode Collation Algorithm".

A memory-optimized version of the proposed collation tables "[AllKeys]" from Unicode Technical Standard #10 is used in order to determine collation weights for Code points between 0000 and 06FF, and composed keys are used for Code points from ranges 0700 to 33FF, A000 to D7FF and E000 to FFFD. Code Points not referenced in these tables will be assigned a default collation weight with their unicode value as level 1 weight. Decomposition is not supported.

Phonebook entries whose names contain only characters from the GSM07.07 default alphabet are converted internally into their UCS2 equivalents in order to achieve consistent sorting results.

For the user, this means that:

- Punctuation marks and other non-alphabetical characters from the common latin-based character sets, and from the standard GSM character set, will be sorted before any alphabetical characters. The ordering in which these marks appear as compared to other non-alphabetical characters from the same group is determined by their collation weights and does not reflect their code values in the UCS2 or GSM alphabet tables above. Please refer to www.unicode.org for detail.
- Alphabetical characters from the common latin-based character sets, and from the standard GSM character set, will be sorted according to their underlying base characters, plus the collation weights of their accent signs.
- Only collation levels 1 and 2 are regarded, so sorting is not case-sensitive.

Example: the european letters "Å" (GSM 0EH, UCS2 00C5h), "æ" (GSM 1DH, UCS2 00E6h), "ç" (GSM09h, UCS2 00E7h), "a" (GSM 61H, UCS2 0061h) and "b" (GSM 62H, UCS2 0062h) will be sorted in order "a", "Å", "æ" "b", "ç" although their numerical values in GSM and UCS2 suggest a different ordering.

Reference(s)

Unicode Technical Standard #10, "Unicode Collation Algorithm"

17.2 AT+CPBR Read from Phonebook

AT+CPBR serves to read one or more entries from the phonebook selected with AT command AT+CPBS.

The AT+CPBR test command returns the location range supported by the current phonebook storage, the maximum length of <number> field and the maximum length of <text> field. Note: Length information may not be available while SIM storage is selected. If storage does not offer format information, the format list contains empty parentheses.

The AT+CPBR write command determines the phonebook entry to be displayed with <location1> or a location range from <location1> to <location2>. Hence, if no <location2> is given only the entry at <location1> will be displayed.

If no entries are found at the selected location "OK" will be returned.

Syntax

<p>Test Command</p> <pre>AT+CPBR=?</pre> <p>Response(s)</p> <pre>+CPBR: (1-<maxloc>), <nlength>, <tlength></pre> <p>OK</p> <p>+CME ERROR</p>	<p>Write Command</p> <pre>AT+CPBR=<location1>[, <location2>]</pre> <p>Response(s)</p> <pre>[+CPBR: <location1>, <number>, <type>, <text>]</pre> <pre>[+CPBR: <location2>, <number>, <type>, <text>]</pre> <p>OK</p> <p>+CME ERROR</p>
<p>Reference(s)</p> <p>GSM 07.07, GSM 11.11</p>	

Parameter Description

<location1>^(num)

The first (lowest) location number within phonebook memory where to start reading. The maximum range supported by the current phonebook is given in the test command response.

If <location1> exceeds the upper bound <maxloc> (as indicated by the test command), command will respond with "+CME ERROR: invalid index".

<location2>^(num)

The last (highest) location number within phonebook memory where to stop reading. The maximum range supported by the current phonebook is given in the test command response.

If both <location1> and <location2> are in the range indicated by the test command parameter <max-loc>, the list of entries will be output and terminated with "OK".

If <location2> exceeds the range indicated by the test command parameter <maxloc>, the list of entries will be output but terminated with "+CME ERROR: invalid index".

<number>^(str)

Phone number in format specified by <type>, it may be an empty string.

`<type>`^(num)

Type of address octet, which defines the used type of number (ton) and the numbering plan identification (npi). Please consider that for types other than 129 or 145 dialing from phonebook with `ATD<mem><n>` is, depending on the network, not always possible (refer to GSM 04.08 subclause 10.5.4.7 for details). See also `<type>` of `AT+CPBW`.

Possible values are:

145	Dialing string <code><number></code> includes international access code character '+'
161	National number. Network support of this type is optional.
209	Dialing string <code><number></code> has been saved as ASCII string and includes non-digit characters other than "*", "#" or "+". Note that phonebook entries saved with this type cannot be dialed.
255	Dialing string <code><number></code> is a command to control a Supplementary Service, i.e. "*", "#" codes are contained. Network support of this type is optional.
129	Otherwise

`<text>`^{(str)(+CSCS)}

Text assigned to a phone number. The maximum length for this parameter is given with test command response parameter `<tlength>`.

If using an ASCII terminal characters which are coded differently in ASCII and GSM have to be entered via escape sequences as described in Section 1.5, [Supported character sets](#).

`<maxloc>`^(num)

Maximum location number for the currently selected storage. For phonebooks located on the SIM this value depends on the SIM card type.

`<nlength>`^(num)

Maximum length of phone number for "normal" locations. Depending on the storage a limited number of locations with extended memory is available per phonebook. These locations allow storing numbers with twice the standard length, which is $2 \cdot \text{<nlength>}$ digits for normal numbers, but only `<nlength>` digits for numbers saved with `<type>=209`.

`<tlength>`^(num)

Maximum length of `<text>` assigned to the telephone number. The value indicated by the test command is given in octets. If `<text>` is given as GSM characters each character corresponds to one octet. If the `<text>` string is given in UCS2, the maximum number of characters depends on the coding scheme used for the alpha field of the SIM according to GSM 11.11, Annex B [24]. In the worst case the number of UCS2 characters is at least one less than half the number of GSM characters.

Note

- `AT+CPBR` can be used only after the phonebook data from the SIM have been read successfully for the first time. Reading starts after successful SIM authentication has been performed, and may take up to 30 seconds depending on the SIM used. While the initial read process is in progress, an attempt to use any of the phonebook commands will result in "+CME Error: 14" (SIM busy). We recommend to take advantage of the "`^SSIM_READY`" URC. If enabled with `AT^SSET`, this URC notifies the user when SIM data are accessible after SIM PIN authentication. The URC will be delivered once the ME has completed reading data from the SIM card.

Example

```
AT+CPBR=?
```

```
+CPBR: (1-100),20,17
```

```
AT+CPBR =1,3
```

```
+CPBR:1,"+999999",145,"Charlie"
```

```
+CPBR:2,"+777777",145,"Bill"
```

```
+CPBR:3,"+888888",145,"Arthur"
```

First run the [AT+CPBR](#) test command to find out the maximum range of entries stored in the active phonebook.

TC65 returns the supported values, where 100 is the supported range of location numbers, 20 is the length of the phone number and 17 is the maximum length of the associated text.

Then use the [AT+CPBR](#) write command to display the phonebook entries sorted by location numbers.

17.3 AT+CPBS Select phonebook memory storage

AT+CPBS selects the active phonebook storage, i.e. the phonebook storage that all subsequent phonebook commands will be operating on.

The read command returns the currently selected **<storage>**, the number of **<used>** entries and the **<total>** number of entries available for this storage. The test command returns all supported **<storage>**s as compound value.

Syntax

<p>Test Command</p> <p>AT+CPBS=?</p> <p>Response(s)</p> <p>+CPBS: (list of supported <storage>s)</p> <p>OK</p> <p>+CME ERROR</p>	
<p>Read Command</p> <p>AT+CPBS?</p> <p>Response(s)</p> <p>+CPBS: <storage>, <used>, <total></p> <p>OK</p> <p>+CME ERROR</p>	
<p>Write Command</p> <p>AT+CPBS=<storage></p> <p>Response(s)</p> <p>OK</p> <p>+CME ERROR:</p>	
<p>Reference(s)</p> <p>GSM07.07</p>	<p>PIN ASC0 ASC1 USB MUX1 MUX2 MUX3 Charge ↗ Last</p> <p>● ● ● ● ● ● ○ ● ○</p>

Parameter Description

<storage> ^(str)	
“FD”	Fixed dialing phonebook Capacity: depending on SIM card Location: SIM
“SM” ^(&F)	SIM phonebook Capacity: depending on SIM card Location: SIM
“ON”	MSISDN list Capacity: depending on SIM card Location: SIM
“ME”	Mobile Equipment Phonebook Capacity: max. 250 entries Location: ME
“LD”	Last number dialed phonebook. Stores all voice call numbers dialed with ATD, but no data call numbers. Capacity: max. 10 entries Location: depending on SIM this phonebook may reside partly or completely in ME AT+CPBW command is not applicable to this storage. The LD list can be deleted with AT^SDLD or with AT^SPBD .

"MC"	Missed (unanswered received) calls list Capacity: max. 10 entries Location: ME AT+CPBW command is not applicable to this storage. The MC list can be deleted with AT^SPBD .
"RC"	Received calls list Capacity: max. 10 entries Location: ME AT+CPBW command is not applicable to this storage. The RC list can be deleted with AT^SPBD .

<used>^(num)

Value indicating the number of used locations in selected memory storage.

<total>^(num)

Value indicating the maximum number of locations allowed in the selected memory storage.

Notes

- The [AT+CPBS](#) read command can be used only after the phonebook data from the SIM have been read successfully for the first time. Reading starts after successful SIM authentication has been performed, and may take up to 30 seconds depending on the SIM used. While the initial read process is in progress, an attempt to use any of the phonebook commands will result in "+CME Error: 14" (SIM busy). We recommend to take advantage of the "^SSIM READY" URC. If enabled with [AT^SSET](#), this URC notifies the user when SIM data are accessible after SIM PIN authentication. The URC will be delivered once the ME has completed reading data from the SIM card.
- If the SIM card is changed, all records of the "MC", "RC" and "LD" phonebooks stored on the ME will be deleted automatically. If the same SIM is removed and reinserted, no automatic deletion is performed. Calls made after last switch-on will be lost from "MC", "RC" and "LD" phonebook, if the SIM is removed and reinserted during normal operation.

17.4 AT+CPBW Write into Phonebook

The **AT+CPBW** write command can be used to create, edit and delete a phonebook entry at a **<location>** of the active storage selected with **AT+CPBS**.

If **<storage>="FD"** (SIM fixed dialing numbers) is selected, PIN2 authentication has to be performed prior to any write access.

The **AT+CPBW** test command returns the location range supported by the current storage, the maximum length of the **<number>** field, the range of supported **<type>** values and the maximum length of the **<text>** field. Note: The length may not be available while SIM storage is selected. If storage does not offer format information, the format list contains empty parentheses.

Syntax

<p>Test Command</p> <p>AT+CPBW=?</p> <p>Response(s)</p> <p>+CPBW: (1-<maxloc>), <nlength>, (list of supported <type>s), <tlength></p> <p>OK</p> <p>ERROR</p> <p>+CME ERROR</p>	<p>Write Command</p> <p>AT+CPBW=[<location>][, <number>[[, <type>][, <text>]]]</p> <p>Response(s)</p> <p>OK</p> <p>ERROR</p> <p>+CME ERROR</p>
<p>Reference(s)</p> <p>GSM 07.07, GSM 04.08</p>	<p>PIN ASC0 ASC1 USB MUX1 MUX2 MUX3 Charge → Last</p> <p>● ● ● ● ● ● ● ○ ● ○</p>

Parameter Description

<location>^(num)

Location number within phonebook memory. The maximum range supported by each storage type is indicated in the test command response. If **<location>** is not given, the first free entry will be used.

If **<location>** is given as the only parameter, the phonebook entry specified by **<location>** is deleted.

<number>^(str)

Phone number in format specified by **<type>**. Parameter must be present, although it may be an empty string. Alphabetic characters are not permitted. **<number>** may contain dialstring modifiers "*", "#" or "+".

If other printable non-alphabetic characters are used the entry needs to be saved with **<type>=209**. Otherwise, if **<type>=209** is not used any non-digit characters other than "*", "#" or "+" will be removed from the string and only accepted modifiers from the GSM alphabet will be saved.

A **<number>** saved with **<type>=209** requires double memory. In order to fit into a standard location, the number needs to be reduced to a maximum length of **<nlength>/2**, including all digits and dial string modifiers. Extended locations may be used as stated below for **<nlength>**.

`<type>`^(num)

Type of address octet, which defines the used type of number (ton) and the numbering plan identification (npi). Please consider that for types other than 129 or 145 dialing from phonebook with `ATD<mem><n>` is, depending on the network, not always possible (refer GSM 04.08 subclause 10.5.4.7 for details).

Supported values are:

145	Dialing string <code><number></code> includes international access code character '+'
161	National number. The network support for this type is optional.
209	Dialing string <code><number></code> will be saved as ASCII string. This is the default value, if <code><type></code> is not specified explicitly and characters other than "*", "#" or "+" are included in <code><number></code> . Note that phonebook entries saved with this type cannot be dialed.
255	Dialing string <code><number></code> is a command to control a Supplementary Service, i.e. "*", "#" codes are contained. Network support of this type is optional.
129	Otherwise This is the default value, if <code><type></code> is not specified explicitly and characters other than "*", "#" or "+" are not included in <code><number></code> .

`<text>`^{(str)(+CSCS)}

Text assigned to the phone number. The maximum length of this parameter is given in the test command response `<tlength>`. When using an ASCII terminal, characters which are coded differently in ASCII and GSM have to be entered via escape sequences as described in Section 1.5, [Supported character sets](#).

`<maxloc>`^(num)

Maximum number of locations supported by the currently selected storage. For phonebooks located on SIM, this value varies depending on the SIM card. See [AT+CPBS](#) for typical values.

`<nlength>`^(num)

Maximum length of phone number for "normal" locations. Depending on the storage, a limited number of locations with extended memory is available per phonebook. These locations allow storing numbers with twice the standard length, which is $2 * \text{<nlength>}$ digits for normal numbers, but only `<nlength>` digits for numbers saved with parameter `<type>= 209`. If all extended locations of the selected phonebook are used up, then any attempt to write a number which requires extended memory will be denied with CME ERROR 260: INVALID DIAL STRING.

`<tlength>`^(num)

Maximum length of `<text>` assigned to the telephone number. The value indicated by the test command is given in octets. If the `<text>` string is given in GSM characters, each character corresponds to one octet. If the `<text>` string is given in UCS2, the maximum number of characters depends on the coding scheme used for the alpha field of the SIM. In the worst case the number of UCS2 characters is at least one less than half the number of GSM characters.

For a detailed description please refer to GSM 11.11, Annex B [\[24\]](#).

Note

- `AT+CPBW` can be used only after the phonebook data from the SIM have been read successfully for the first time. Reading starts after successful SIM authentication has been performed, and may take up to 30 seconds depending on the SIM used. While the initial read process is in progress, an attempt to use any of the phonebook commands will result in "+CME Error: 14" (SIM busy). We recommend to take advantage of the "`^SSIM_READY`" URC. If enabled with `AT^SSET`, this URC notifies the user when SIM data are accessible after SIM PIN authentication. The URC will be delivered once the ME has completed reading data from the SIM card.

Examples

EXAMPLE 1

Make a new phonebook entry at the first free location

```
AT+CPBW=,"+431234567",145,"international"
```

EXAMPLE 2

Delete entry at location 1

```
AT+CPBW=1
```

EXAMPLE 3

The following examples are provided to illustrate the effect of writing phonebook entries with different types of dial string modifiers in [<number>](#)

```
AT+CPBW=5,"12345678",,"Arthur"  
AT+CPBW=6,"432!+-765()&54*654#",,"John"  
AT+CPBW=7,"432!+-765()&54*654#",129,"Eve"  
AT+CPBW=8,"432!+-765()&54*654#",145,"Tom"  
AT+CPBW=9,"432!+-765()&54*654#",209,"Richard"
```

EXAMPLE 4

Read phonebook entries from locations 5 - 9 via [AT+CPBR](#)

```
+CPBR:5,"12345678",129,"Arthur"  
+CPBR:6,"432!+-765()&54*654#",209,"John"  
+CPBR:7,"432+76554*654#",129,"Eve"  
+CPBR:8,"+432+76554*654#",145,"Tom"  
+CPBR:9,"432!+-765()&54*654#",209,"Richard"
```

17.5 AT^SDLD Delete the 'last number redial' memory

[AT^SDLD](#) deletes all numbers stored in the "LD" memory.

Syntax

Test Command	
AT^SDLD=?	
Response(s)	
OK	
Exec Command	
AT^SDLD	
Response(s)	
OK	
ERROR	
+CME ERROR: <err>	
Reference(s)	
SIEMENS	

PIN	ASC0	ASC1	USB	MUX1	MUX2	MUX3	Charge	→	Last
●	●	●	●	●	●	●	○	●	○

Note

- [AT^SDLD](#) can be used only after the phonebook data from the SIM have been read successfully for the first time. Reading starts after successful SIM authentication has been performed, and may take up to 30 seconds depending on the SIM used. While the initial read process is in progress, an attempt to use any of the phonebook commands will result in "+CME Error: 14" (SIM busy). We recommend to take advantage of the "[^SSIM_READY](#)" URC. If enabled with [AT^SSET](#), this URC notifies the user when SIM data are accessible after SIM PIN authentication. The URC will be delivered once the ME has completed reading data from the SIM card.

17.6 AT^SPBC Find first matching entry in sorted phonebook

The `AT^SPBC` write command searches the current phonebook for the index number of the first (lowest) entry that matches the character specified with `<schar>`. The `AT^SPBC` test command returns the list of phonebooks which can be searched through with `AT^SPBC`.

CAUTION: Please note that `AT^SPBC` is assigned the same index as `AT^SPBG` or `AT^SPBS` which is not identical with the physical location numbers used in the various phonebooks. Therefore, do not use the index numbers retrieved with `AT^SPBC` to dial out or modify phonebook entries.

Syntax

<p>Test Command</p> <pre>AT^SPBC=?</pre> <p>Response(s)</p> <pre>^SPBC: "FD","SM","ME" OK ERROR +CME ERROR</pre>	<p>Write Command</p> <pre>AT^SPBC=<schar></pre> <p>Response(s)</p> <pre>^spbc: <index> OK ERROR +CME ERROR</pre>
<p>Reference(s)</p> <p>SIEMENS</p>	

Parameter Description

`<schar>`^(str)

First character of the entry to be searched in the sorted list of phonebook entries.

`<index>`^(num)

In the active phonebook, the first (lowest) index number of an entry beginning with `<schar>`. As stated above, the retrieved index number shall not be used to dial out or edit phonebook entries. If no matching phonebook entry is found, `<index>=0` will be returned.

Note

- `AT^SPBC` can be used only after the phonebook data from the SIM have been read successfully for the first time. Reading starts after successful SIM authentication has been performed, and may take up to 30 seconds depending on the SIM used. While the initial read process is in progress, an attempt to use any of the phonebook commands will result in "+CME Error: 14" (SIM busy). We recommend to take advantage of the "`^SSIM_READY`" URC. If enabled with `AT^SSET`, this URC notifies the user when SIM data are accessible after SIM PIN authentication. The URC will be delivered once the ME has completed reading data from the SIM card.

17.7 AT^SPBD Purge phonebook memory storage

[AT^SPBD](#) can be used to purge the selected phonebook `<storage>` manually, i.e. all entries stored in the selected phonebook storage will be deleted. CAUTION! The operation cannot be stopped nor reversed!

The [AT^SPBD](#) test command returns the list of phonebooks which can be deleted with [AT^SPBD](#).

An automatic purge of the phonebooks is performed when the SIM card is removed and replaced with a different SIM card. This affects the ME based part of the "LD" storage, and storages "MC" and "RC". Storage "ME" is not affected.

Syntax

<p>Test Command</p> <pre>AT^SPBD=?</pre> <p>Response(s)</p> <pre>^SPBD: list of supported <storage>s OK +CME ERROR</pre>	<p>Write Command</p> <pre>AT^SPBD=<storage></pre> <p>Response(s)</p> <pre>OK +CME ERROR</pre>
<p>Reference(s)</p> <p>SIEMENS</p>	

Parameter Description

`<storage>`^(str)

If test command: List of phonebooks which can be deleted by [AT^SPBD](#).

If write command: Phonebook to be deleted.

For a detailed description of storages see [AT+CPBS](#).

"LD"	Last number dialed phonebook
"MC"	Missed (unanswered received) calls list
"RC"	Received calls list

Note

- [AT^SPBD](#) can be used only after the phonebook data from the SIM have been read successfully for the first time. Reading starts after successful SIM authentication has been performed, and may take up to 30 seconds depending on the SIM used. While the initial read process is in progress, an attempt to use any of the phonebook commands will result in "+CME Error: 14" (SIM busy).

We recommend to take advantage of the "[^SSIM READY](#)" URC. If enabled with [AT^SSET](#), this URC notifies the user when SIM data are accessible after SIM PIN authentication. The URC will be delivered once the ME has completed reading data from the SIM card.

17.8 AT^SPBG Display phonebook entries in alphabetical order

AT^SPBG sorts the entries of the current phonebook in alphabetical order by name (the first six characters matter). The sort order is described in Section 17.1, [Sort Order for Phonebooks](#).

There are two ways to use AT^SPBG:

- If the optional parameter `<RealLocReq>` equals 0 or is omitted the sorted entries will be sequentially numbered. As these numbers are not identical with the location numbers stored in the various phonebooks AT^SPBG can be used for reading only. For example, it helps you find entries starting with matching characters. Do not use the serial numbers to dial out or modify entries.
- If parameter `<RealLocReq>=1` is given by the write command, the response parameter `<location>` additionally appended to each entry indicates the actual location number. This number can be used for editing with AT+CPBW or dialing with ATD<mem><n>. The first index number of each entry is only the serial number of the sorted list.

Before using the AT^SPBG write command it is recommended to query the number of records currently stored in the active phonebook (refer to test command parameter `<used>`). The test command also includes the parameters `<nlength>` and `<tlength>`. Note that if SIM storage is selected the length may not be available. If storage does not offer format information, the format list should be empty parentheses.

Syntax

<p>Test Command</p> <pre>AT^SPBG=?</pre> <p>Response(s)</p> <pre>^SPBG: (1-<used>), <nlength>, <tlength> OK ERROR +CME ERROR</pre>	<p>Write Command</p> <pre>AT^SPBG=<index1>[, <index2>][, <RealLocReq>]</pre> <p>Response(s)</p> <pre>[^SPBG: <index1>, <number>, <type>, <text>[, <location>]] [^SPBG: <index2>, <number>, <type>, <text>[, <location>]] OK ERROR +CME ERROR</pre>
<p>Reference(s)</p> <p>SIEMENS</p>	

Parameter Description

`<index1>`^(num)

First index number in the sorted list where to start reading. The supported range is given in the test command response.

If `<index 1>` exceeds the upper bound `<used>`, "+CME ERROR: "invalid index" will be returned.

`<index2>`^(num)

Last index number in the sorted list where to stop reading. The supported range is given in the test command response.

If `<index2>` is not given via write command, only the entry located at `<index1>` will be displayed.

If both `<index1>` and `<index2>` are in the range indicated by the test command parameter `<used>`, the list of entries will be output and terminated with OK.

If `<index2>` exceeds the range indicated by the test command parameter `<used>`, the list of entries will be output but terminated with a "+CME ERROR: "invalid index".

`<RealLocReq>`^(num)

Is a display of the "real" `<location>` of the entry required?

- | | |
|-----|---|
| [0] | Do not show an entry's "real" location number. Parameter <code><location></code> will not be displayed. |
| 1 | Show the "real" location number as parameter <code><location></code> at the end of each entry. |

`<number>`^(str)

String type phone number in format specified by `<type>`.
The number parameter may be an empty string.

`<type>`^(num)

Type of address octet, which defines the used type of number (ton) and the numbering plan identification (npi). Please consider that for types other than 129 or 145 dialing from phonebook with `ATD<mem><n>` is, depending on the network, not always possible (refer to GSM 04.08 subclause 10.5.4.7 for details). See also `<type>` of `AT+CPBW`.

Possible values are:

- | | |
|-----|--|
| 145 | Dialing string <code><number></code> includes international access code character '+' |
| 161 | National number. Network support of this type is optional. |
| 209 | Dialing string <code><number></code> has been saved as ASCII string and includes non-digit characters other than "*", "#" or "+". Note that phonebook entries saved with this type cannot be dialed. |
| 255 | Dialing string <code><number></code> is a command to control a Supplementary Service, i.e. "*", "#" codes are contained. Network support of this type is optional. |
| 129 | Otherwise |

`<text>`^{(str)(+CSCS)}

Text assigned to the phone number. The maximum length for this parameter is given in test command response `<tlength>`.

`<used>`^(num)

Value indicating the number of used locations in selected memory storage.

`<location>`^(num)

The location within phonebook memory at which the corresponding entry is located.
This location may be used for other commands (e.g. `AT+CPBR` or `ATD<mem><n>`)

`<nlength>`^(num)

Maximum length of phone number for "normal" locations. Depending on the storage, a limited number of locations with extended memory is available per phonebook. Please refer to AT command `AT+CPBW` for detail.

`<tlength>`^(num)

Maximum length of `<text>` assigned to the telephone number. The value indicated by the test command is given in octets. If the `<text>` string is given in GSM characters, each character corresponds to one octet. If the `<text>` string is given in UCS2, the maximum number of characters depends on the coding scheme used for the alpha field of the SIM according to GSM 11.11, Annex B [24]. In the worst case the number of UCS2 characters is at least one less than half the number of GSM characters.

Notes

- The command can be used for the phonebooks "SM", "FD", "ME" (cf. AT+CPBS).
- AT^SPBG can be used only after the phonebook data from the SIM have been read successfully for the first time. Reading starts after successful SIM authentication has been performed, and may take up to 30 seconds depending on the SIM used. While the initial read process is in progress, an attempt to use any of the phonebook commands will result in "+CME Error: 14" (SIM busy). We recommend to take advantage of the "^SSIM_READY" URC. If enabled with AT^SSET, this URC notifies the user when SIM data are accessible after SIM PIN authentication. The URC will be delivered once the ME has completed reading data from the SIM card.

Examples

EXAMPLE 1

Using AT^SPBG without <RealLocReq>:

<pre>AT^SPBG=? ^SPBG: (1-33),20,17 AT^SPBG=1,33 ^SPBG:1,"+999999",145,"Arthur" ^SPBG:2,"+777777",145,"Bill" ^SPBG:3,"+888888",145,"Charlie"</pre>	<p>First run the AT^SPBG test command to find out the range of entries stored in the current phonebook. TA returns the range, where 33 is the number of entries stored in the current phonebook. Now, enter the write command. To obtain best results it is recommended to query the full range of entries. TA returns phonebook entries in alphabetical order.</p>
--	---

The numbers at the beginning of each line are not the memory locations in the phonebook, but only serial numbers assigned to the entries' positions in the alphabetical list.

EXAMPLE 2

Using AT^SPBG with <RealLocReq>:

<pre>AT^SPBG=? ^SPBG: (1-33),20,17 AT^SPBG=1,33,1 ^SPBG:1,"+999999",145,"Arthur",27 ^SPBG:2,"+777777",145,"Bill",6 ^SPBG:3,"+888888",145,"Charlie",15</pre>	<p>First run the AT^SPBG test command to find out the range of entries stored in the current phonebook. TA returns the range, where 33 is the number of entries stored in the current phonebook. Now, enter the write command including parameter <RealLocReq>=1 to get the actual location numbers.</p>
--	--

The numbers at the end of each line are the memory locations in the phonebook and can be used for dialing or editing phonebook entries:

<pre>AT+CPBR=27 +CPBR: 27,"+999999",145,"Arthur"</pre>	<p>Read out phonebook location 27. This entry can be edited with AT+CPBW or used for dialing with ATD<mem><n>.</p>
--	--

17.9 AT^SPBS Step through the selected phonebook alphabetically

AT^SPBS can be used to scroll sequentially through the active phonebook records in alphabetical order by name. Three entries will be displayed at a time.

Every time the write command is executed, 3 rows of phonebook records are returned. Each triplet overlaps with the next one. The actual index depends on parameter <value>. This parameter determines whether the index will be increased or decreased.

If the index in one output line reaches the last index in the alphabetical list, the next output line will display the first list entry.

After the last record of the phonebook has been reached (see parameter <used> for AT^SPBG), the <internal-counter> switches over to the first.

There are two ways to use AT^SPBS:

- If the optional parameter <RealLocReq> is omitted or (0) the sorted entries will be sequentially numbered. As these numbers are not identical with the location numbers stored in the various phonebooks AT^SPBS can be used for reading only. For example, it helps you find entries starting with matching characters. Do not use the serial numbers to dial out or modify entries.
- If parameter <RealLocReq>=1 is given by the write command, the response parameter <location> additionally appended to each entry indicates the actual location number. This number can be used for editing with AT+CPBW or dialing with ATD<mem><n>. The first index number of each entry is only the serial number of the sorted list.

See examples below.

Syntax

<p>Test Command</p> <pre>AT^SPBS=?</pre> <p>Response(s)</p> <pre>^SPBS: (list of supported <value>) OK</pre>	<p>Write Command</p> <pre>AT^SPBS=<value>[, <RealLocReq>]</pre> <p>Response(s)</p> <pre>^SPBS: <index-a>, <number>, <type>, <text>[, <location>] ^SPBS: <index-b>, <number>, <type>, <text>[, <location>] ^SPBS: <index-c>, <number>, <type>, <text>[, <location>] OK +CME ERROR</pre>
<p>Reference(s)</p> <p>SIEMENS</p>	

Parameter Description

<value> ^(num)	
1	To make a step forward in the alphabetically sorted phonebook.
2	To make a step backward in the alphabetically sorted phonebook.
<index-a> ^(num)	
1...maxindex	The index in the sorted list of phonebook entries that identifies the first entry displayed. The value of <index-a> is determined by the value of the <internal-counter> and by parameter <value>.

After a write command has terminated successfully with "OK", the value from parameter `<index-a>` is saved and retained as the new `<internal-counter>` value.

Mind after the last record of phonebook, the first entry follows.

`<index-b>`^(num)

1...maxindex The index in the sorted list of phonebook entries that identifies the second entry displayed.

`<index-b>= (<index-a>+1)`.

Mind after the last record of phonebook, the first entry follows.

`<index-c>`^(num)

1...maxindex The index in the sorted list of phonebook entries that identifies the third entry displayed.

`<index-c>= (<index-b>+1)`.

Mind after the last record of phonebook, the first entry follows.

`<number>`^(str)

String type phone number in format specified by `<type>`.
the number parameter may be an empty string.

`<type>`^(num)

Type of address octet, which defines the used type of number (ton) and the numbering plan identification (npi). Please consider that for types other than 129 or 145 dialing from phonebook with `ATD<mem><n>` is, depending on the network, not always possible (refer to GSM 04.08 subclause 10.5.4.7 for details). See also `<type>` of `AT+CPBW`.

Possible values are:

- | | |
|-----|--|
| 145 | Dialing string <code><number></code> includes international access code character '+' |
| 161 | National number. Network support of this type is optional. |
| 209 | Dialing string <code><number></code> has been saved as ASCII string and includes non-digit characters other than "*", "#" or "+". Note that phonebook entries saved with this type cannot be dialed. |
| 255 | Dialing string <code><number></code> is a command to control a Supplementary Service, i.e. "*", "#" codes are contained. Network support of this type is optional. |
| 129 | Otherwise |

`<text>`^{(str)(+CSCS)}

Text assigned to the phone number.

`<RealLocReq>`^(num)

Is a display of the "real" `<location>` of the entry required?

- | | |
|-----|--|
| [0] | Do not show an entry's "real" location number. Parameter <code><location></code> will not be displayed |
| 1 | Show the "real" location number as parameter <code><location></code> at the end of the entry |

`<location>`^(num)

The location within phonebook memory at which the corresponding entry is located.

This location may be used for other phonebook commands (e.g. `AT+CPBR`, `AT+CPBW`, `ATD<mem><n>`).

<internal-counter>^(num)

0^(&F)...maxindex

This parameter is only an internal parameter and cannot be modified directly. The internal counter will be reset to index 0 after a call to [ATZ](#) or [AT&F](#).

Notes

- The complete list of sorted entries can be retrieved using AT command [AT^SPBG](#).
- The command can be used for the phonebooks "SM", "FD", "ME" (cf. [AT+CPBS](#)).
- [AT^SPBG](#) can be used only after the phonebook data from the SIM have been read successfully for the first time. Reading starts after successful SIM authentication has been performed, and may take up to 30 seconds depending on the SIM used. While the initial read process is in progress, an attempt to use any of the phonebook commands will result in "+CME Error: 14" (SIM busy). We recommend to take advantage of the "[^SSIM READY](#)" URC. If enabled with [AT^SSET](#), this URC notifies the user when SIM data are accessible after SIM PIN authentication. The URC will be delivered once the ME has completed reading data from the SIM card.

Examples

EXAMPLE 1

This example illustrates how to search down and up again using [AT^SPBS=1](#) and 2:

```
at&f
OK
at^spbs=1
^SPBS:1,"+999999",145,"Arthur"
^SPBS:2,"+777777",145,"Bill"
^SPBS:3,"+888888",145,"Charlie"

OK
at^spbs=1
^SPBS:2,"+777777",145,"Bill"
^SPBS:3,"+888888",145,"Charlie"
^SPBS:4,"0304444444",129,"Esther"

OK
at^spbs=1
^SPBS:3,"+888888",145,"Charlie"
^SPBS:4,"0304444444",129,"Esther"
^SPBS:5,"0303333333",129,"Harry"

OK
at^spbs=2
^SPBS:2,"+777777",145,"Bill"
^SPBS:3,"+888888",145,"Charlie"
^SPBS:4,"0304444444",129,"Esther"

OK
```

First, [AT&F](#) is issued to make sure that [AT^SPBS=1](#) starts from the first character in alphabetical order.

EXAMPLE 2

This example shows that when the last index in the sorted list has been reached, the internal counter overflows to the first index.

```
at&f
OK
at^spbs=2
^SPBS:33,"+49301234567",145,"TomTailor"
^SPBS:1,"+999999",145,"Arthur"
^SPBS:2,"+777777",145,"Bill"

OK
```

Reset internal counter to 0.

Step down one entry starting from (internal counter)=0 - overflow occurs.

EXAMPLE 3

Using `AT^SPBS` with `<RealLocReq>=1` in order to obtain the entries' location numbers:

```
at^spbs=1,1  
  
^SPBS:1,"+999999",145,"Arthur",27  
^SPBS:2,"+777777",145,"Bill",6  
^SPBS:3,"+888888",145,"Charlie",15
```

The numbers at the end of each line are the memory locations in the phonebook and can be used for dialing or editing phonebook entries:

```
at+cpbr=27  
+CPBR: 27,"+999999",145,"Arthur"
```

Read out phonebook location 27.
This entry can be edited with `AT+CPBW` or used for dialing with `ATD<mem><n>`.

18. Audio Commands

The AT Commands described in this chapter are related to the TC65's audio interface.

18.1 Audio programming model

The following figure illustrates how the signal path can be adjusted with the parameters `<inCalibrate>`, `<inBbcGain>`, `<outBbcGain>`, `<outCalibrate>` and `<sideTone>` as well as `<io>`, `<mic>` and `<ep>`.

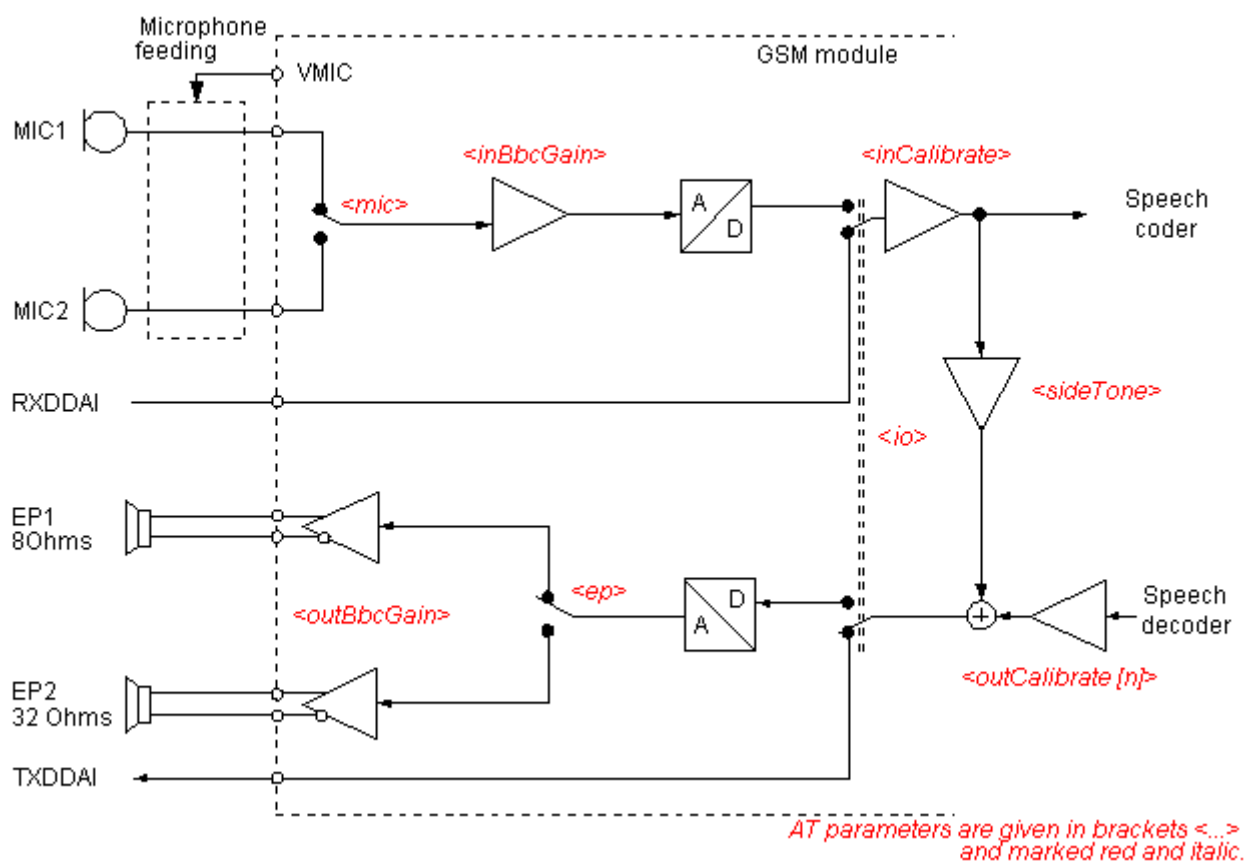

Figure 18.1: Audio programming model

18.2 ATL Set monitor speaker loudness

Syntax

Exec Command	ATL[<val>]																				
Response(s)	OK																				
Reference(s)	V.250																				
	<table border="1"> <tr> <td>PIN</td> <td>ASC0</td> <td>ASC1</td> <td>USB</td> <td>MUX1</td> <td>MUX2</td> <td>MUX3</td> <td>Charge</td> <td>→</td> <td>Last</td> </tr> <tr> <td><input type="radio"/></td> <td><input checked="" type="radio"/></td> <td><input type="radio"/></td> <td><input checked="" type="radio"/></td> <td><input checked="" type="radio"/></td> <td><input type="radio"/></td> <td><input type="radio"/></td> <td><input type="radio"/></td> <td><input checked="" type="radio"/></td> <td><input type="radio"/></td> </tr> </table>	PIN	ASC0	ASC1	USB	MUX1	MUX2	MUX3	Charge	→	Last	<input type="radio"/>	<input checked="" type="radio"/>	<input type="radio"/>	<input checked="" type="radio"/>	<input checked="" type="radio"/>	<input type="radio"/>	<input type="radio"/>	<input type="radio"/>	<input checked="" type="radio"/>	<input type="radio"/>
PIN	ASC0	ASC1	USB	MUX1	MUX2	MUX3	Charge	→	Last												
<input type="radio"/>	<input checked="" type="radio"/>	<input type="radio"/>	<input checked="" type="radio"/>	<input checked="" type="radio"/>	<input type="radio"/>	<input type="radio"/>	<input type="radio"/>	<input checked="" type="radio"/>	<input type="radio"/>												

Parameter Description

<val>^(num)

Notes

- Commands [ATL](#) and [ATM](#) are implemented only for V.250ter compatibility reasons and have no effect.
- In Multiplex mode the command is supported on logical channel 1 only.

18.3 ATM Set monitor speaker mode

Syntax

Exec Command	ATM[<val>]																				
Response(s)	OK																				
Reference(s)	V.250																				
	<table border="1"> <tr> <td>PIN</td> <td>ASC0</td> <td>ASC1</td> <td>USB</td> <td>MUX1</td> <td>MUX2</td> <td>MUX3</td> <td>Charge</td> <td>→</td> <td>Last</td> </tr> <tr> <td><input type="radio"/></td> <td><input checked="" type="radio"/></td> <td><input type="radio"/></td> <td><input checked="" type="radio"/></td> <td><input checked="" type="radio"/></td> <td><input type="radio"/></td> <td><input type="radio"/></td> <td><input type="radio"/></td> <td><input checked="" type="radio"/></td> <td><input type="radio"/></td> </tr> </table>	PIN	ASC0	ASC1	USB	MUX1	MUX2	MUX3	Charge	→	Last	<input type="radio"/>	<input checked="" type="radio"/>	<input type="radio"/>	<input checked="" type="radio"/>	<input checked="" type="radio"/>	<input type="radio"/>	<input type="radio"/>	<input type="radio"/>	<input checked="" type="radio"/>	<input type="radio"/>
PIN	ASC0	ASC1	USB	MUX1	MUX2	MUX3	Charge	→	Last												
<input type="radio"/>	<input checked="" type="radio"/>	<input type="radio"/>	<input checked="" type="radio"/>	<input checked="" type="radio"/>	<input type="radio"/>	<input type="radio"/>	<input type="radio"/>	<input checked="" type="radio"/>	<input type="radio"/>												

Parameter Description

<val>^(num)

Notes

- Commands [ATL](#) and [ATM](#) are implemented only for V.250ter compatibility reasons and have no effect.
- In Multiplex mode the command is supported on logical channel 1 only.

18.4 AT+CLVL Loudspeaker volume level

Syntax

<p>Test Command</p> <pre>AT+CLVL=?</pre> <p>Response(s)</p> <pre>+CLVL: (list of supported<level>s) OK</pre>																					
<p>Read Command</p> <pre>AT+CLVL?</pre> <p>Response(s)</p> <pre>+CLVL: <level> OK ERROR +CME ERROR: <err></pre>																					
<p>Write Command</p> <pre>AT+CLVL=<level></pre> <p>Response(s)</p> <pre>OK ERROR +CME ERROR: <err></pre>																					
<p>Reference(s)</p> <p>GSM 07.07</p>	<table border="1"> <tr> <td>PIN</td> <td>ASC0</td> <td>ASC1</td> <td>USB</td> <td>MUX1</td> <td>MUX2</td> <td>MUX3</td> <td>Charge</td> <td>→</td> <td>Last</td> </tr> <tr> <td><input type="radio"/></td> <td><input checked="" type="radio"/></td> <td><input checked="" type="radio"/></td> <td><input checked="" type="radio"/></td> <td><input checked="" type="radio"/></td> <td><input checked="" type="radio"/></td> <td><input checked="" type="radio"/></td> <td><input type="radio"/></td> <td><input checked="" type="radio"/></td> <td><input type="radio"/></td> </tr> </table>	PIN	ASC0	ASC1	USB	MUX1	MUX2	MUX3	Charge	→	Last	<input type="radio"/>	<input checked="" type="radio"/>	<input checked="" type="radio"/>	<input checked="" type="radio"/>	<input checked="" type="radio"/>	<input checked="" type="radio"/>	<input checked="" type="radio"/>	<input type="radio"/>	<input checked="" type="radio"/>	<input type="radio"/>
PIN	ASC0	ASC1	USB	MUX1	MUX2	MUX3	Charge	→	Last												
<input type="radio"/>	<input checked="" type="radio"/>	<input checked="" type="radio"/>	<input checked="" type="radio"/>	<input checked="" type="radio"/>	<input checked="" type="radio"/>	<input checked="" type="radio"/>	<input type="radio"/>	<input checked="" type="radio"/>	<input type="radio"/>												

Parameter Description

<p><level>^(num)</p> <p>Loudspeaker Volume Level</p> <p>0...4^(D)</p>

Notes

- The write command can only be used in audio mode 2 - 6.
- The values of the volume steps are specified with the parameters <outCalibrate>[0],...<outCalibrate>[4] of the AT[^]SNFO command.
- As an alternative to AT+CLVL, you can use AT[^]SNFO and AT[^]SNFV. The parameter <level> is identical with <outStep> used by both commands.
- Any change to <level> (or <outStep>) takes effect in audio modes 2 to 6. That is, when you change <level> (or <outStep>) and then select another mode with AT[^]SNFS, the same step will be applied. The only exception is audio mode 1 which is fixed to <level>=4 (or accordingly <outStep>=4).
- <level> (or <outStep>) is stored non-volatile when the ME is powered down with AT[^]SMSO or reset with AT+CFUN=1,1.

18.5 AT+CMUT Mute control

The **AT+CMUT** command mutes the microphone input. The command can be used in all audio modes (1 to 6) and during a voice call only. See **AT^SNFS** for more details on the various audio modes. As alternative, you can use the **AT^SNFM** command.

During an active call, users should be aware that when they switch back and forth between different audio modes (for example handsfree on/off) the value of **<mute>** does not change, i.e. the microphone mode is retained until explicitly changed.

Syntax

<p>Test Command</p> <p>AT+CMUT=?</p> <p>Response(s)</p> <p>+CMUT: (list of supported<mute>s)</p> <p>OK</p>	
<p>Read Command</p> <p>AT+CMUT?</p> <p>Response(s)</p> <p>+CMUT: <mute></p> <p>OK</p> <p>ERROR</p> <p>+CME ERROR: <err></p>	
<p>Write Command</p> <p>AT+CMUT=<mute></p> <p>Response(s)</p> <p>OK</p> <p>ERROR</p> <p>+CME ERROR: <err></p>	
<p>Reference(s)</p> <p>GSM 07.07</p>	<p>PIN ASC0 ASC1 USB MUX1 MUX2 MUX3 Charge ↗ Last</p> <p><input type="radio"/> <input checked="" type="radio"/> <input checked="" type="radio"/> <input checked="" type="radio"/> <input checked="" type="radio"/> <input checked="" type="radio"/> <input checked="" type="radio"/> <input checked="" type="radio"/> <input type="radio"/> <input checked="" type="radio"/> <input type="radio"/></p>

Parameter Description

<mute> ^(num)	
0 ^(P)	Mute off
1	Mute on

18.6 AT+VTD Tone duration

This command refers to an integer `<duration>` that defines the length of tones transmitted with the `AT+VTS` command.

Syntax

<p>Test Command</p> <p>AT+VTD=?</p> <p>Response(s)</p> <p>+VTD: (list of supported<duration>s)</p> <p>OK</p>	
<p>Read Command</p> <p>AT+VTD?</p> <p>Response(s)</p> <p><duration></p> <p>OK</p>	
<p>Write Command</p> <p>AT+VTD=<duration></p> <p>Response(s)</p> <p>OK</p>	
<p>Reference(s)</p> <p>GSM 07.07</p>	<p>PIN ASC0 ASC1 USB MUX1 MUX2 MUX3 Charge → Last</p> <p>○ ● ● ● ● ● ● ○ ○ ○</p>

Parameter Description

<p><code><duration></code>^(num)</p> <p>Duration of the tone in 1/10 second</p> <p>1(&F)...255</p>
--

18.7 AT+VTS DTMF and tone generation

AT+VTS is intended to send ASCII characters or strings which cause the Mobile Switching Center (MSC) to transmit DTMF tones to a remote subscriber. The command can only be used during active voice calls and offers the following variants:

- **AT+VTS=<dtmfString>** allows to send a sequence of DTMF tones with a duration defined with **AT+VTD**.
- **AT+VTS=<dtmf>[,<duration>]** allows to send a single DTMF tone. In this case, the duration can be individually determined during the call.

Syntax

<p>Test Command</p> <p>AT+VTS=?</p> <p>Response(s)</p> <p>+VTS: (list of supported<dtmf>s), (list of supported<duration>s)</p> <p>OK</p>																					
<p>Write Command</p> <p>AT+VTS=<dtmfString></p> <p>Response(s)</p> <p>OK</p>																					
<p>Write Command</p> <p>AT+VTS=<dtmf>[, <duration>]</p> <p>Response(s)</p> <p>OK</p>																					
<p>Reference(s)</p> <p>GSM 07.07</p>	<table border="1"> <tr> <td>PIN</td> <td>ASC0</td> <td>ASC1</td> <td>USB</td> <td>MUX1</td> <td>MUX2</td> <td>MUX3</td> <td>Charge</td> <td>→</td> <td>Last</td> </tr> <tr> <td><input type="radio"/></td> <td><input checked="" type="radio"/></td> <td><input checked="" type="radio"/></td> <td><input checked="" type="radio"/></td> <td><input checked="" type="radio"/></td> <td><input checked="" type="radio"/></td> <td><input checked="" type="radio"/></td> <td><input type="radio"/></td> <td><input type="radio"/></td> <td><input type="radio"/></td> </tr> </table>	PIN	ASC0	ASC1	USB	MUX1	MUX2	MUX3	Charge	→	Last	<input type="radio"/>	<input checked="" type="radio"/>	<input checked="" type="radio"/>	<input checked="" type="radio"/>	<input checked="" type="radio"/>	<input checked="" type="radio"/>	<input checked="" type="radio"/>	<input type="radio"/>	<input type="radio"/>	<input type="radio"/>
PIN	ASC0	ASC1	USB	MUX1	MUX2	MUX3	Charge	→	Last												
<input type="radio"/>	<input checked="" type="radio"/>	<input checked="" type="radio"/>	<input checked="" type="radio"/>	<input checked="" type="radio"/>	<input checked="" type="radio"/>	<input checked="" type="radio"/>	<input type="radio"/>	<input type="radio"/>	<input type="radio"/>												

Parameter Description

<dtmfString>^(str)

String of ASCII characters in the set 0-9,#,*,A, B, C, D. Maximal length of the string is 29. The string must be enclosed in quotation marks ("...").

<dtmf>^(str)

ASCII character in the set 0...9,#,*, A, B, C, D.

<duration>^(num)

Tone duration in 1/10 second. If not specified current setting of **AT+VTD** is used.

1...255

18.8 AT^SAIC Audio Interface Configuration

The **AT^SAIC** command configures the interface connections of the active audio mode. The write command is usable only in audio modes 2 - 6.

If **AT^SNFS=1**, any attempt to use the **AT^SAIC** write command returns "+CME ERROR: operation not allowed". This is because all default parameters in audio mode 1 are determined for type approval and are not adjustable. To allocate a specific audio mode to one of the audio interfaces, first select the audio mode with **AT^SNFS** and then choose the interface using **AT^SAIC**.

Syntax

<p>Test Command</p> <p>AT^SAIC=?</p> <p>Response(s)</p> <p>^SAIC: (list of supported <io>s), (list of supported <mic>s), (list of supported <ep>s)</p> <p>OK</p>	
<p>Read Command</p> <p>AT^SAIC?</p> <p>Response(s)</p> <p>^SAIC: <io>, <mic>, <ep></p> <p>OK</p>	
<p>Write Command</p> <p>AT^SAIC=<io>[, <mic>[, <ep>]]</p> <p>Response(s)</p> <p>OK</p> <p>ERROR</p> <p>+CME ERROR: operation not allowed</p>	
<p>Reference(s)</p> <p>SIEMENS</p>	<p>PIN ASC0 ASC1 USB MUX1 MUX2 MUX3 Charge Last</p>

Parameter Description

<io> ^(num) (^SNFW)	
Input and output selection	
1	Digital input and output
2	Analog input and output
<mic> ^(num) (^SNFW)	
Microphone selection	
1	Microphone 1
2	Microphone 2
<ep> ^(num) (^SNFW)	
Select differential earpiece amplifier	
1	Selects the earpiece amplifier 1
2	Selects the earpiece amplifier 2
3	Selects both amplifiers. Note that both amplifiers are connected in parallel and therefore, get the same output power if <ep>=3.

Notes

- The factory defaults of AT^SAIC vary with the selected audio mode.
If AT^SNFS=1 or 4 or 5, then AT^SAIC=2,1,1.
If AT^SNFS=2 or 3 or 6, then AT^SAIC=2,2,2.
AT^SNFD can be used to reset the factory defaults.
- For use after restart of the ME, you are advised to store the settings of AT^SAIC and AT^SNFS to the audio profile saved with AT^SNFW. Otherwise, audio mode 1 (AT^SNFS=1) and audio interface 2 (AT^SAIC=2,1,1) will be active each time the ME is powered up.

18.9 AT^SNFA Set or query of microphone attenuation

[AT^SNFA](#) specifies the large-scale attenuation on the microphone path of the audio device currently selected with [AT^SNFS](#). The write command is only available in audio modes 2 - 6.

Syntax

<p>Test Command</p> <p>AT^SNFA=?</p> <p>Response(s)</p> <p>^SNFA: (list of supported <atten>s)</p> <p>OK</p>	
<p>Read Command</p> <p>AT^SNFA?</p> <p>Response(s)</p> <p>^SNFA: <atten></p> <p>OK</p>	
<p>Write Command</p> <p>AT^SNFA=<atten></p> <p>Response(s)</p> <p>OK</p> <p>ERROR</p> <p>CME ERROR: <err></p>	
<p>Reference(s)</p> <p>SIEMENS</p>	

Parameter Description

<atten> ^(num) (^SNFW)	
Multiplication factor for input samples. Parameter <atten> is identical with <inCalibrate> of AT^SNFI . Formula used to calculate microphone attenuation (negative gain): Gain in dB = 20 * log(<atten>/32768)	
0...32767 ^(P) ...65535	
0	Microphone is muted. Please note that AT^SNFA cannot be used to mute the microphone - any attempt to enter 0 will be denied and responded with "+CME Error: invalid index". Value 0 is returned only by the read command AT^SNFA? after the microphone was muted with AT^SNFM=0 during an active call.
32767	No attenuation on the microphone path Values greater than 32767 will be suppressed to 32767.

Notes

- The command is provided for compatibility with M20 and is a subset of [AT^SNFI](#). The parameter <inCalibrate> of [AT^SNFI](#) is identical with <atten> of [AT^SNFA](#).
- To make the changes persistent use [AT^SNFW](#).

Example

```
^SYSSTART
at^snfa=?
^SNFA: (0-65535)
OK
at^snfa?
^SNFA: 32767
OK
at^snfs=4
OK
at^snfa=1
OK
at^snfa?
^SNFA: 1
OK
at^snfi?
^SNFI: 5,1
OK
at^snfi=5,45
OK
at^snfa?
^SNFA: 45
OK
```

18.10 AT^SNFD Set audio parameters to manufacturer default values

AT^SNFD sets the active audio parameters to manufacturer defined default values.
The restored values are:

AT^SNFA: <atten>

AT^SNFI: <inBbcGain>, <inCalibrate>

AT^SNFO: <outBbcGain>, <outCalibrate>[0 to 4], <sideTone>

AT^SAIC: <io>, <mic>, <ep>

AT^SNFS: <audMode>

Syntax

Test Command	AT^SNFD=?
Response(s)	OK
Exec Command	AT^SNFD
Response(s)	OK
Reference(s)	SIEMENS

The hardware status bar includes the following indicators: PIN (off), ASC0 (on), ASC1 (on), USB (on), MUX1 (on), MUX2 (on), MUX3 (on), Charge (off), and Last (off).

Note

- Remember that the factory set audio mode 1 is fixed to <outStep>=4. Consequently, AT^SNFD restores <audMode> together with <outStep>=4, but does not affect the values of <outStep> currently selected in audio modes 2 - 6. This means, if <audMode>=1, the read commands AT^SNFO, AT^SNFV and AT+CLVL will always deliver <outStep>=4. In all other modes the <outStep> value is retained until explicitly changed.

18.11 AT^SNFI Set microphone path parameters

AT^SNFI controls the microphone path amplification. Read and write options of this command refer to the active audio mode. The write command works only in audio modes 2 to 6.

Syntax

<p>Test Command</p> <p>AT^SNFI=?</p> <p>Response(s)</p> <p>^SNFI: (list of supported <inBbcGain>s) , (list of supported <inCalibrate>s)</p> <p>OK</p>	
<p>Read Command</p> <p>AT^SNFI?</p> <p>Response(s)</p> <p>^SNFI: <inBbcGain>, <inCalibrate></p> <p>OK</p>	
<p>Write Command</p> <p>AT^SNFI=<inBbcGain>, <inCalibrate></p> <p>Response(s)</p> <p>OK</p>	
<p>Reference(s)</p> <p>SIEMENS</p>	

Parameter Description

<inBbcGain>^{(num)(^SNFW)}

ADC gain adjustable in eight 6 dB steps from 0 dB to 42 dB (0=0dB, 7=42dB, 8 steps of 6 dB).

0...7

<inCalibrate>^{(num)(^SNFW)}

Multiplication factor for input samples. Formula to calculate the negative gain (attenuation) of the input signal:
Gain in dB = 20 * log (inCalibrate / 32768)

0...32767

Notes

- The range of <inCalibrate> is up to 65535 but will be suppressed to 32767. Values above <inCalibrate>= 65535 will cause a failure.
- The parameter <inCalibrate> of AT^SNFI is identical with <atten> of AT^SNFA.
- For use after restart, changed values can be stored with AT^SNFW.
- Attention! When you adjust audio parameters avoid exceeding the maximum allowed level. Bear in mind that exposure to excessive levels of noise can cause physical damage to users!

18.12 AT^SNFM Set microphone audio path and power supply

The `AT^SNFM` read command returns the microphone mute and supply voltage status.

The `AT^SNFM` write command can be used to switch the microphone's audio path (muted / not muted) or to control the power supply of the VMIC line for the two microphone inputs.

The microphone can be muted or activated by changing `<MicSwitch>` in all audio modes (1 to 6) and during a voice call only. As an alternative, you can use the `AT+CMUT` command to mute the microphone.

Syntax

<p>Test Command</p> <pre>AT^SNFM=?</pre> <p>Response(s)</p> <pre>^SNFM: (list of supported <MicSwitch>s) , (list of supported <MicVccCtl>s) OK</pre>	
<p>Read Command</p> <pre>AT^SNFM?</pre> <p>Response(s)</p> <pre>^SNFM: <MicSwitch>, <MicVccState> OK</pre>	
<p>Write Command</p> <pre>AT^SNFM=[<MicSwitch>][, <MicVccCtl>]</pre> <p>Response(s)</p> <pre>OK</pre>	
<p>Reference(s)</p> <p>SIEMENS</p>	

Parameter Description

`<MicSwitch>`^(num)

Microphone mute control parameter.

Evaluated during voice calls and if `<MicVccCtl>` is omitted only, e.g. `AT^SNFM=1`.

Command does not depend on audio mode.

- 0 Mutes the microphone.
- 1^(P) Activates the microphone.

`<MicVccCtl>`^(num)

Microphone supply voltage control parameter. Controls the power supply VMIC of the two microphone inputs. CME error is given if `<MicSwitch>` is not omitted. Enter for example `AT^SNFM=,1` or `AT^SNFM=,2`.

- 0 Supply voltage is always switched off.
- 1 Supply voltage is always switched on.
- 2^(P) Supply voltage state during voice calls is controlled by the ME. Actual value is determined by parameter data set of the selected audio mode.

<MicVccState>^(num)

Microphone supply voltage control status.

- | | |
|---|--|
| 0 | Supply voltage was set to a constant value. |
| 2 | Supply voltage state is controlled by the ME and depends on parameter data set of the selected audio mode. |

Notes

- The programmable power supply of the VMIC line gives you greater flexibility in connecting audio accessories or using the two analog audio interfaces for a variety of functions other than audio. A detailed description of the extended usage of the analog audio interfaces can be found in [\[9\]](#).
- During an active call, users should be aware that when they switch back and forth between different audio modes (for example handsfree on/off) the value of <MicSwitch> does not change, i.e. the microphone mode is retained until explicitly changed.

18.13 AT^SNFO Set audio output (= loudspeaker path) parameter

AT^SNFO controls the earpiece path amplification. The read and write commands refer to the active audio mode. The write command works only in audio modes 2 to 6.

Syntax

<p>Test Command</p> <p>AT^SNFO=?</p> <p>Response(s)</p> <p>^SNFO: (list of supported <outBbcGain>s) (list of supported <outCalibrate>s) (list of supported <outStep>s) (list of supported <sideTone>s)</p> <p>OK</p>	
<p>Read Command</p> <p>AT^SNFO?</p> <p>Response(s)</p> <p>^SNFO: <outBbcGain>, <outCalibrate>[0], <outCalibrate>[1], <outCalibrate>[2], <outCalibrate>[3], <outCalibrate>[4], <outStep>, <sideTone></p> <p>OK</p>	
<p>Write Command</p> <p>AT^SNFO=<outBbcGain>, <outCalibrate>[0], <outCalibrate>[1], <outCalibrate>[2], <outCalibrate>[3], <outCalibrate>[4], <outStep>, <sideTone></p> <p>Response(s)</p> <p>OK</p>	
<p>Reference(s)</p> <p>SIEMENS</p>	<p>PIN ASC0 ASC1 USB MUX1 MUX2 MUX3 Charge → Last</p> <p><input type="radio"/> <input checked="" type="radio"/> <input checked="" type="radio"/> <input checked="" type="radio"/> <input checked="" type="radio"/> <input checked="" type="radio"/> <input checked="" type="radio"/> <input checked="" type="radio"/> <input type="radio"/> <input checked="" type="radio"/> <input type="radio"/></p>

Parameter Description

<outBbcGain>^{(num)(^SNFW)}

Negative DAC gain (attenuation) adjustable in four 6 dB steps from 0 dB to -18 dB (0=0 dB, 3=-18 dB)

0...3

<outCalibrate>^{(num)(^SNFW)}

Formula to calculate the value of the 5 volume steps selectable with parameter <outStep>:

Attenuation = 20 * log (2 * outCalibrate[n] / 32768)

0...32767

<outStep>^(num)

Volume steps 0 - 4, each defined with outCalibrate[n]

0...[4]

<sideTone>^{(num)(^SNFW)}

Multiplication factor for the sidetone gain.

Formula to calculate how much of the original microphone signal is added to the earpiece signal:

Sidetone gain in dB = 20 * log (sideTone / 32768).

0...32767

Notes

- `<outCalibrate>` specifies the amount of volume of each `<outStep>`. The range of each `<outCalibrate>` is up to 65535, but will be suppressed to 32767. A value above `<outCalibrate>=65535` will cause an error.
- The range of `<sideTone>` is up to 65535, but will be suppressed to 32767. A value above `<sideTone>=65535` will cause an error.
- Any change to `<outStep>` takes effect in audio modes 2 to 6. That is, when you change `<outStep>` and then select another mode with `AT^SNFS`, the same step will be applied. Nevertheless, the sound quality and the amount of volume are not necessarily the same, since all remaining audio parameters can use different values in either mode.
- Audio mode 1 is fixed to `<outStep>=4`. In this mode, any attempt to change `<outStep>` or other parameters returns an error.
- The value of `<outStep>` is stored non-volatile when the ME is powered down with `AT^SMSO` or reset with `AT+CFUN=x,1`. Any other parameters changed with `AT^SNFO` need to be saved with `AT^SNFW` for use after restart. See also `AT^SNFD` for details on restoring factory defaults.
- The values of `<outStep>` can also be changed with `AT^SNFV` and `AT+CLVL`.
- CAUTION! When you adjust audio parameters avoid exceeding the maximum allowed level. Bear in mind that exposure to excessive levels of noise can cause physical damage to users!

18.14 AT^SNFPT Set progress tones

[AT^SNFPT](#) controls the Call Progress Tones generated at the beginning of a mobile originated call setup. Please note that the setting is stored volatile, i.e. after restart or reset, the default value 1 will be restored.

Syntax

<p>Test Command</p> <p>AT^SNFPT=?</p> <p>Response(s)</p> <p>^SNFPT: (list of supported <pt>s)</p> <p>OK</p>	
<p>Read Command</p> <p>AT^SNFPT?</p> <p>Response(s)</p> <p>^SNFPT: <pt></p> <p>OK</p>	
<p>Write Command</p> <p>AT^SNFPT=<pt></p> <p>Response(s)</p> <p>OK</p>	
<p>Reference(s)</p> <p>SIEMENS</p>	<p>PIN ASC0 ASC1 USB MUX1 MUX2 MUX3 Charge ↗ Last</p> <p><input type="radio"/> <input checked="" type="radio"/> <input checked="" type="radio"/> <input checked="" type="radio"/> <input checked="" type="radio"/> <input checked="" type="radio"/> <input checked="" type="radio"/> <input checked="" type="radio"/> <input type="radio"/> <input checked="" type="radio"/> <input type="radio"/></p>

Parameter Description

<pt> ^(num)	Description
0	Disables Call Progress Tones
1 ^(P)	Enables Call Progress Tones (audible tones shortly heard on the phone when ME starts to set up a call.)

18.15 AT^SNFS Select audio hardware set

The [AT^SNFS](#) write command serves to set the audio mode required for the connected equipment. [AT^SNFS](#) can also be used in conjunction with [AT^SAIC](#). This is useful, for example, if the audio interfaces are operated alternatively to benefit from different devices. Each audio mode can be assigned a specific interface. To do so, first select the audio mode with [AT^SNFS](#), then activate the audio interface with [AT^SAIC](#) and finally enter [AT^SNFW](#) to store the settings to your audio profile. To switch back and forth it is sufficient to use [AT^SNFS](#).

Syntax

<p>Test Command</p> <p>AT^SNFS=?</p> <p>Response(s)</p> <p>^SNFS: (list of supported <audMode>s)</p> <p>OK</p>	
<p>Read Command</p> <p>AT^SNFS?</p> <p>Response(s)</p> <p>^SNFS: <audMode></p> <p>OK</p>	
<p>Write Command</p> <p>AT^SNFS=<audMode></p> <p>Response(s)</p> <p>OK</p> <p>ERROR</p> <p>CME ERROR: <err></p>	
<p>Reference(s)</p> <p>SIEMENS</p>	<p>PIN ASC0 ASC1 USB MUX1 MUX2 MUX3 Charge ↗ Last</p> <p><input type="radio"/> <input checked="" type="radio"/> <input checked="" type="radio"/> <input checked="" type="radio"/> <input checked="" type="radio"/> <input checked="" type="radio"/> <input checked="" type="radio"/> <input checked="" type="radio"/> <input type="radio"/> <input checked="" type="radio"/> <input type="radio"/></p>

Parameter Description

<audMode> ^(num) (^SNFW)	
[1]	<p>Audio mode 1: Standard mode optimized for the reference handset, that can be connected to the analog interface 1 (see "TC65 Hardware Interface Description" for information on this handset.) To adjust the volume use the knob of the reference handset. In audio mode 4, this handset can be used with user defined parameters.</p> <p>Note: The default parameters are determined for type approval and are not adjustable with AT commands.</p> <p>AT^SNFD restores <audMode> 1.</p>
2	<p>Audio mode 2: Customer specific mode for a basic handsfree (speakerphone) device (Siemens Car Kit Portable).</p> <p>Analog interface 2 is assumed as default.</p>
3	<p>Audio mode 3: Customer specific mode for a mono-headset.</p> <p>Analog interface 2 is assumed as default.</p>
4	<p>Audio mode 4: Customer specific mode for a user handset.</p> <p>Analog interface 1 is assumed as default.</p>
5	<p>Audio mode 5: Customer specific mode.</p> <p>Analog interface 1 is assumed as default.</p>
6	<p>Audio mode 6: Customer specific mode.</p> <p>Analog interface 2 is assumed as default.</p>

Notes

- The write command can be used during a voice call to switch back and forth between different modes. This allows the user, for example, to switch handsfree operation (speakerphone) on and off.
- Users should be aware that `<outStep>` is a global setting. This means, when another audio mode is selected during a call, the value of `<outStep>` does not change. This is also true for mute operation which can be set with `AT^SNFM` or `AT+CMUT`: If the microphone is muted and the user selects another audio mode during the call, then the microphone remains muted until explicitly changed. Exception: In audio mode 1 `<outStep>=4` is fix.
- For use after restart of the module, you are advised to store the selected mode to the audio profile saved with `AT^SNFW`. Otherwise, audio mode 1 will be active each time the module is powered up.

Examples

EXAMPLE 1

Suppose a user wishes to use alternatively a handsfree device (speakerphone) and a handset. The handset can be connected to the first analog interface and adjusted to audio mode 4. The handsfree device can be attached to the second analog interface and adjusted to audio mode 2. The factory defaults of `AT^SAIC` need not be changed.

Settings for the handset:

```
AT^SNFS=4
OK
AT^SAIC?                               Factory default of AT^SAIC assigned to audio mode 4.
^SAIC: 2,1,1
OK
```

Settings for the handsfree device:

```
AT^SNFS=2
OK
AT^SAIC?                               Factory default of AT^SAIC assigned to audio mode 2.
^SAIC: 2,2,2
OK
```

To store the configuration to the user defined audio profile:

```
AT^SNFW                               Stores the audio mode and the interface.
OK
```

To switch back and forth:

```
AT^SNFS=4                               Switches to the handset connected to analog interface 1.
OK
AT^SNFS=2                               Switches to the handsfree device at analog interface 2.
OK
```

EXAMPLE 2

The following example illustrates a combination of a handset and a handsfree device connected to other interfaces than those assumed as factory default.

Settings for a handset connected to the second analog interface and adjusted to audio mode 4:

```
AT^SNFS=4
OK
AT^SAIC=2,2,2
OK
```

Settings for a handsfree device connected to the first analog interface and adjusted to audio mode 2:

```
AT^SNFS=2
OK
AT^SAIC=2,1,1
OK
```

To store the configuration to the user defined audio profile:

AT^SNFW OK	Stores the audio mode and the interface.
---------------	--

To switch back and forth:

AT^SNFS=4 OK	Switches to the handset connected to analog interface 1.
AT^SNFS=2 OK	Switches to the handsfree device at analog interface 2.

18.16 AT^SNFTTY Signal TTY/CTM audio mode capability

TC65 offers basic support for equipment using the CTM standard (Cellular Text Telephone Modems). The benefit of CTM is that text characters typed on a TTY device (Text Telephone Type-writer) can be transformed into special audio burst signals for reliable transmission via the existing speech channels of a cellular phone system.

If CTM mode is activated, the ME will set the necessary bearer capability bit on outgoing (mobile originated) calls and incoming calls with this bearer capability bit set are accepted. The TE needs to decode the special audio burst signals.

If CTM mode is disabled, the ME will clear the bearer capability bit on mobile originated calls and incoming calls with the bearer capability bit set are rejected because the TC65 expects that CTM coded speech data can not be decoded by the TE.

Designed to set the module's speech system into CTM mode, the `AT^SNFTTY` command allows a CTM device to be connected to one of the three audio interfaces of TC65. Traditional TTY devices that do not incorporate CTM functionality can be connected through an external TTY-to-CTM adapter.

Related documents: Refer to the relevant standards, such as 3GPP TS 26.226 (ETSI TS 126 226) and 3GPP TS 23.228 (ETSI TS 123 226). 3GPP documentation can be retrieved, for example, from <http://www.3gpp.org/specs/specs.htm>. Application Note 22 "Using TTY/CTM equipment" supplies information needed to connect TTY/CTM equipment to the TC65.

Requirements for using TTY/CTM features:

- TTY/CTM functionality requires audio mode 5 or 6 with all audio parameters set to their factory default. To do so, first enter the `AT^SNFS` command to select audio mode 5, then use `AT^SNFI` and `AT^SNFO` to restore the default values. Alternatively, factory defaults of all audio parameters in audio modes 2 - 6 can easily be set with `AT^SNFD`.
- Depending on which audio interface the CTM device is connected to select the according settings via `AT^SAIC`.

Syntax

```
Test Command
AT^SNFTTY=?
Response(s)
^SNFTTY: (list of supported <audioState>s)
OK

Read Command
AT^SNFTTY?
Response(s)
^SNFTTY: <audioState>
OK

Write Command
AT^SNFTTY=<audioState>
Response(s)
OK
```

Reference(s)

SIEMENS

PIN	ASC0	ASC1	USB	MUX1	MUX2	MUX3	Charge	→	Last
●	●	●	●	●	●	●	○	○	○

Parameter Description

<audioState> ^(num)	Description
0	Audio path is in normal speech mode.
1	Audio path is in TTY/CTM mode.

18.17 AT^SNFV Set loudspeaker volume

AT^SNFV can be used to set the volume of the loudspeaker to the value <outCalibrate> addressed by <outStep>. The read and write commands refer to the active audio mode. The write command works only in audio modes 2 to 6.

Syntax

<p>Test Command</p> <p>AT^SNFV=?</p> <p>Response(s)</p> <p>^SNFV: (list of supported <outStep>s)</p> <p>OK</p>	
<p>Read Command</p> <p>AT^SNFV?</p> <p>Response(s)</p> <p>^SNFV: <outStep></p> <p>OK</p>	
<p>Write Command</p> <p>AT^SNFV=<outStep></p> <p>Response(s)</p> <p>OK</p> <p>ERROR</p> <p>+CME ERROR</p>	
<p>Reference(s)</p> <p>SIEMENS</p>	

Parameter Description

<outStep>^(num)

The actual volume of each step is defined by the parameter <outCalibrate>, which can be set with AT^SNFO. 0...4^(P)

Notes

- Any change to <outStep> takes effect in audio modes 2 to 6. That is, when you change <outStep> and then select another mode with AT^SNFS, the same step will be applied. Nevertheless, the actual volume can be quite different, depending on the values of <outCalibrate> set in each mode. The only exception is audio mode 1 which is fixed to <outStep>=4.
- <outStep> is stored non-volatile when the ME is powered down with AT^SMSO or reset with AT+CFUN=1,1. <outStep> is not stored by AT^SNFW.
- <outStep> can also be changed by AT^SNFO (Section 18.13) and AT+CLVL (Section 18.4).

18.18 AT^SNFW Write audio setting in non-volatile store

AT^SNFW causes the TA to write the currently selected audio parameters to non-volatile store. The saved audio profile includes the following parameters:

AT^SNFA: <atten>

AT^SNFI: <inBbcGain>, <inCalibrate>

AT^SNFO: <outBbcGain>, <outCalibrate>[0 to 4], <sideTone>

AT^SNFS: <audMode>

AT^SAIC: <io>, <mic>, <ep>.

Syntax

Test Command	
AT^SNFW=?	
Response(s)	
OK	
Exec Command	
AT^SNFW	
Response(s)	
OK	
ERROR	
CME ERROR: <err>	
Reference(s)	
SIEMENS	

PIN	ASC0	ASC1	USB	MUX1	MUX2	MUX3	Charge	→	Last
<input type="radio"/>	<input checked="" type="radio"/>	<input checked="" type="radio"/>	<input checked="" type="radio"/>	<input checked="" type="radio"/>	<input checked="" type="radio"/>	<input checked="" type="radio"/>	<input type="radio"/>	<input checked="" type="radio"/>	<input type="radio"/>

18.19 AT^SRTC Ring tone configuration

The `AT^SRTC` read command returns the current `<type>` and current `<volume>`. The read command can be used while test playback is off or on. In the latter case, see execute command for details.

The `AT^SRTC` execute command is intended for testing. It starts to play a melody from the audio output currently selected with `AT^SNFS`. To deactivate test playback use `AT^SRTC` again. During test playback, you can enter the write command to select another melody and adjust the volume. Also, you can enter the read command to check the type and volume of the current ring tone, and to view the status of playback (on / off). The test ringing signal cannot be activated when an MTC is ringing (ERROR). Selecting `<volume>=0` during the test, immediately stops playback. After this, ring tones will be muted until you change `<volume>` using the write command.

The `AT^SRTC` write command chooses the type and volume of ring tones. The settings can be changed no matter whether or not the ME is ringing. The selected type and volume are saved in the non-volatile Flash memory and, thus, are retained after Power Down. An exception is `<type>=0`, that can be entered to quickly mute the tone or melody currently played to indicate an event. `<type>=0` only stops immediately the audible ring tone, but does not terminate the URC that indicates the event (for example RING). No permanent settings are changed or saved.

Syntax

<p>Test Command</p> <p><code>AT^SRTC=?</code></p> <p>Response(s)</p> <p><code>^SRTC: (list of supported) <type>s, (list of supported) <volume>s</code></p> <p>OK</p>	
<p>Read Command</p> <p><code>AT^SRTC?</code></p> <p>Response(s)</p> <p><code>^SRTC: <type>, <volume>, <status></code></p> <p>OK</p>	
<p>Exec Command</p> <p><code>AT^SRTC</code></p> <p>Response(s)</p> <p>OK</p>	
<p>Write Command</p> <p><code>AT^SRTC=[<type>][, <volume>]</code></p> <p>Response(s)</p> <p><code>^SRTC: <type>, <volume></code></p> <p>OK</p> <p>ERROR</p>	
<p>Reference(s)</p> <p>SIEMENS</p>	<p>PIN ASC0 ASC1 USB MUX1 MUX2 MUX3 Charge → Last</p> <p>○ ● ● ● ● ● ● ○ ● ○</p>

Parameter Description

`<type>`^(num)

Type of ring tone. You have a choice of 7 different ring tones and melodies. All will be played from the audio output selected with the `AT^SNFS` command. `<type>=0` is only intended for muting.

0	Mutes the currently played tone immediately.
1	Sequence 1
2	Sequence 2
3 ^(D)	Sequence 3
4	Sequence 4
5	Sequence 5
6	Sequence 6
7	Sequence 7

`<volume>`^(num)

Volume of ring tone, varies from low to high

0 ^(D)	Mute
1	Very low
2	Identical with 1
3	Low
4	Identical with 3
5	Middle
6	Identical with 5
7	High

`<status>`^(num)

Status of test ringing. Indicates whether or not a melody is currently being played back for testing

0	Switched off
1	Switched on

Notes

- Before first using ring tones note that the following settings apply:
We have chosen to let you decide your own preferences when you start using ring tones. Therefore, factory setting is `AT^SRTC=3,0,0` (ring tones are muted). To activate ring tones for the very first time, first enter the write command and simply change the volume. After applying a firmware update the volume and type selected before the firmware update will be preserved.
- The test ringing signal cannot be activated while an MTC is ringing (ERROR).
- If an MTC arrives during test playback, test ringing will be deactivated and "normal" ringing reactivated (RING). Likewise, an MOC will also stop test ringing.
- If no optional parameter is entered, the old value will be kept.

19. Hardware related Commands

The AT Commands described in this chapter are related to the TC65's hardware interface. More information regarding this interface is available with the "TC65 Hardware Interface Description"[\[2\]](#).

19.1 AT+CCLK Real Time Clock

Syntax

<p>Test Command</p> <p>AT+CCLK=?</p> <p>Response(s)</p> <p>OK</p>	
<p>Read Command</p> <p>AT+CCLK?</p> <p>Response(s)</p> <p>+CCLK: <time></p> <p>OK</p>	
<p>Write Command</p> <p>AT+CCLK=<time></p> <p>Response(s)</p> <p>+CME ERROR: <err></p> <p>ERROR</p> <p>OK</p>	
<p>Reference(s)</p> <p>GSM 07.07</p>	

Parameter Description

<time>^(str)

Format is "yy/mm/dd, hh:mm:ss", where the characters indicate the two last digits of the year, followed by month, day, hour, minutes, seconds; for example 6th of July 2005, 22:10:00 hours equals to "05/07/06,22:10:00"
Factory default is "02/01/01,00:00:00"

Notes

- <time> is retained if the device enters the Power Down mode via [AT^SMSO](#).
- <time> will be reset to its factory default if power is totally disconnected. In this case, the clock starts with <time>="02/01/01,00:00:00" upon next power-up.
- Each time TC65 is restarted it takes 2s to re-initialize the RTC and to update the current time. Therefore, it is recommended to wait 2s before using the commands [AT+CCLK](#) and [AT+CALA](#) (for example 2s after ^SYSSTART has been output).

19.2 AT+CALA Set alarm time

The [AT+CALA](#) write command can be used to set an alarm time in the ME or to clear a programmed alarm. When the alarm time is reached and the alarm is executed the ME returns an Unsolicited Result Code (URC) and the alarm time is reset to "00/01/01,00:00:00".

The alarm can adopt two functions, depending on whether or not you switch the GSM engine off after setting the alarm:

- **Reminder message:** You can use the alarm function to generate reminder messages. For this purpose, set the alarm as described below and do not switch off or power down the ME. When executed the message comes as an Unsolicited Result Code which reads "+CALA".
- **Airplane mode:** The alarm function can be used to wake up the ME at a scheduled time. For this purpose, set the alarm as described below. Then power down the ME by entering the [AT^SMSO](#) command. When the alarm time is reached the ME enters the Airplane mode, notified to the user by the URC "[^SYSSTART AIRPLANE MODE](#)" and, if available, by a user defined text message (specified with [<text>](#)). In Airplane mode, the RF interface of the ME is shut down to prevent it from unintentionally logging into the GSM network. All AT commands whose execution requires a radio connection are disabled. A list of AT commands supported during Airplane mode can be found in Section [22.4, Availability of AT Commands Depending on Operating Mode of ME](#). To return from Airplane mode to Normal mode use the [AT^SCFG](#) command and set the parameter [<map>](#) to "off". This immediately activates the RF interface and restores access to all AT commands. The URC "[^SYSSTART](#)" notifies the user that the ME has returned to Normal mode. Please note that setting an alarm with [AT+CALA](#) is one method to wake up into Airplane mode. The second approach is using the [AT^SCFG](#) command, parameter [<mapos>](#). For further detail on Airplane mode refer to Section [2.14, AT^SCFG](#).

The [AT+CALA](#) test command returns the supported array index values [<n>](#), the supported alarm types [<type>](#) and the maximum length of the text [<tlength>](#) to be output.

The [AT+CALA](#) read command returns the current alarm settings in the ME.

Syntax

<p>Test Command</p> <p>AT+CALA=?</p> <p>Response(s)</p> <p>+CALA: (list of supported<n>s), (list of supported<type>s), (list of supported<tlength>s)</p> <p>OK</p> <p>ERROR</p> <p>+CME ERROR: <err></p>	
<p>Read Command</p> <p>AT+CALA?</p> <p>Response(s)</p> <p>+CALA: <time>[, <n>[, <type>[, <text>]]]</p> <p>OK</p> <p>ERROR</p> <p>+CME ERROR: <err></p>	
<p>Write Command</p> <p>AT+CALA=<time>[, <n>[, <type>[, <text>]]]</p> <p>Response(s)</p> <p>OK</p> <p>ERROR</p> <p>+CME ERROR</p>	
<p>Reference(s)</p> <p>GSM 07.07</p>	<p>PIN ASC0 ASC1 USB MUX1 MUX2 MUX3 Charge → Last</p> <p>○ ● ● ● ● ● ● ● ○</p>

Unsolicited Result Code

+CALA: [`<text>`]

Indicates reminder message.

After power-down and wake-up at the scheduled time, the following URC indicates that the ME has entered the Airplane mode:

"^SYSSTART AIRPLANE MODE"

+CALA: [`<text>`]

Parameter Description

`<time>`^(str)

Format is "yy/MM/dd, hh:mm:ss". For example, 6th of July 2005, 22:10:00 equals to "05/07/06,22:10:00" (see also [AT+CCLK](#)).

Note: If `<time>` equals current date and time or is set to an earlier date, TA returns +CME ERROR: 21.

To clear a given alarm before its scheduled time simply enter an empty string for parameter `<time>`. See examples below.

`<n>`^(num)

Integer type value indicating the array index of the alarm.

The ME allows to set only one alarm at a time. Therefore, the list of supported alarm events indicated by the test command `AT+CALA=?` is `<n>=0`. If a second alarm time is set, the previous alarm will be deleted. Therefore, the read command `AT+CALA?` will always return `<n>=0`. This is also true if individual settings are made on ASC0 and ASC1 or the various Multiplexer channels, for details see notes below.

`<type>`^(num)

Integer type value indicating the type of the alarm.

0 Alarm indication: text message via serial interface

`<text>`^(str)

String type value indicating the text to be displayed when alarm time is reached; maximum length is `<tlength>`. By factory default, `<text>` is undefined.

Note: `<text>` will be stored to the non-volatile flash memory when the device enters the Power Down mode via `AT^SMSO`. Once saved, it will be available upon next power-up, until you overwrite it by typing another text. This eliminates the need to enter the full string when setting a fresh alarm.

`<text>` should not contain characters which are coded differently in ASCII and GSM (e.g. umlauts), see also "Supported character sets" and "GSM alphabet tables".

`<tlength>`^(num)

Integer type value indicating the maximum length of `<text>`. The maximum length is 16.

Notes

- After the alarm was executed the parameter `<time>` of `AT+CALA` will be reset to "00/01/01,00:00:00", but `<text>` will be preserved as described above.
- If TC65 is totally disconnected from power supply the most recently saved configuration of `+CALA: <time>[,<n>[,<type>[,<text>]]]` will be presented when TC65 is powered up.
- Each time TC65 is restarted with ignition it takes 2s to re-initialize the RTC and to update the current time. Therefore, it is recommended to wait 2s before using the commands `AT+CCLK` and `AT+CALA` (for example 2s after ^SYSSTART has been output).

- Alarm settings on ASC0 / ASC1 and different Multiplexer channels (see [AT+CMUX](#)):
 - On each interface an individual `<text>` message can be stored, but only one time setting applies. This means an alarm `<time>` set on one of the interfaces overwrites the time setting on all remaining interfaces. Therefore, the total number of alarm events returned by the read command `AT+CALA?` will always be `<n>=0`, no matter whether different text messages are stored.
 - When the scheduled alarm occurs, the ME sends the URC only on the interface where the most recent alarm setting was made. The alarm time will be reset to "00/01/01,00:00:00" on all interfaces.

Examples

EXAMPLE 1

You may want to configure a reminder message for July 31, 2005, at 9.30h, including the message "Good Morning".

```
AT+CALA="05/07/31,09:30:00",0,0,"Good Morning"  
OK
```

Do not switch off the GSM engine. When the alarm occurs the ME returns the following URC:

```
+CALA: Good Morning
```

EXAMPLE 2

To set a fresh alarm using the same message as in Example 1, simply enter date and time. `<n>`, `<type>`, `<text>`, `<tlength>` can be omitted:

```
AT+CALA="05/07/31,08:50:00"  
OK
```

When the alarm is executed the URC comes with the same message:

```
+CALA: Good Morning
```

EXAMPLE 3

To enable the ME to wake up into Airplane mode, e.g. on July 20, 2005, at 8.30h, enter

```
AT+CALA="05/07/20,08:30:00"  
OK
```

Next, power down the ME:

```
AT^SMSO  
^SMSO: MS OFF  
OK  
^SHUTDOWN
```

When the alarm is executed the ME wakes up to Airplane mode and displays a URC. If available, this line is followed by the individual `<text>` most recently saved. If no individual message was saved only the first line appears.

```
"^SYSSTART AIRPLANE MODE"  
+CALA: Good Morning
```

EXAMPLE 4

To delete an alarm before its scheduled time is reached enter an empty string for parameter `<time>`. This will restore the default time and clear any individual message defined with `<text>`.

```
AT+CALA=""  
OK  
AT+CALA?  
+CALA: "00/01/01,00:00:00",0,0,""  
OK
```

19.3 AT^SBC Battery Charge Control

The functions of the `AT^SBC` differ depending on whether or not a battery is present.

- General functions:
The `AT^SBC` write command enables the presentation of URCs alerting the user of undervoltage and over-voltage conditions before the module switches off. The automatic shutdown caused by undervoltage or over-voltage is equivalent to the power-down initiated with the `AT^SMSO` command, i.e. ME logs off from the network and the software enters a secure state avoiding loss of data. When the module is in IDLE mode it takes typically one minute to deregister from the network and to switch off. For further details regarding automatic shutdown and voltage ratings please refer to the Hardware Interface Description [2].
- Functions available with battery connected:
The `AT^SBC` read command can be used to query the status of the battery and the charger.
The `AT^SBC` write command is important for entering the current consumption of the external application via `<current>`. It should be noted that the charge control supported by TC65 works only if the requirements described in the Hardware Interface Description [2] are met (battery type Lithium-Ion or Lithium Polymer, presence of an NTC and protection circuit etc.) and if `<current>` is correctly specified. If the battery does not incorporate an NTC, or the battery and the NTC are not compliant with the specified requirements the battery cannot be detected by TC65.

Syntax

<p>Test Command</p> <pre>AT^SBC=?</pre> <p>Response(s)</p> <pre>^SBC: (list of supported <bc>s), (list of supported <bcl>s), (list of supported <mpc>s) OK</pre>	
<p>Read Command</p> <pre>AT^SBC?</pre> <p>Response(s)</p> <pre>^SBC: <bc>, <bcl>, <mpc> OK ERROR +CME ERROR: <err></pre>	
<p>Write Command</p> <pre>AT^SBC=<current></pre> <p>Response(s)</p> <pre>OK ERROR +CME ERROR: <err></pre>	
<p>Reference(s)</p> <p>SIEMENS</p>	<p>PIN ASC0 ASC1 USB MUX1 MUX2 MUX3 Charge → Last</p> <p>○ ● ● ● ● ● ● ● ○</p>

Unsolicited Result Codes

URC 1

`^SBC: Undervoltage`

The message will be reported, for example, when the user attempts to set up a call while the voltage is close to the critical limit and further power loss is caused during the transmit burst. When the external charging circuit includes an NTC connected to the BATT_TEMP pin, the URC appears several times before the module switches off.

In applications which are not battery operated, i.e. where no NTC is connected to the BATT_TEMP pin, TC65 will present the undervoltage URC only once and will then switch off without sending any further messages.

URC 2

^SBC: Overvoltage warning

This URC is an alarm indicator displayed when the supply voltage approaches its maximum level. The URC appears only once.

URC 3

^SBC: Overvoltage shutdown

This URC will be reported when the voltage exceeds the maximum level specified in the Hardware Interface Description [2]. It appears only once before the module starts to perform an orderly shutdown.

In applications powered from Lithium batteries the incorporated protection circuit typically prevents overcharging, thus eliminating the risk of overvoltage conditions. Yet, in case of charging errors, for example caused by a bad battery or due to the absence of a battery protection circuit, the module's overvoltage shutdown function will take effect to avoid overcharging.

Parameter Description

<bcs>^(num)

Connection status of battery pack

0	No charging adapter is connected
1	Charging adapter is connected
2	Charging adapter is connected, charging in progress
3	Charging adapter is connected, charging has finished
4	Charging error, charging is interrupted
5	False charging temperature, charging is interrupted while temperature is beyond allowed range

<bcl>^(num)

Battery capacity

0, 20, 40, 60, 80, 100 percent of remaining capacity (6 steps).

0 indicates that either the battery is exhausted or the capacity value is not available.

While charging is in progress (charging adapter connected) the battery capacity is not available. Consequently, parameter <bcl>=0. To query the battery capacity disconnect the charger.

<mpc>^(num)

Current consumption of the host application as specified with parameter <current>.

<current>^(num)

Enter the current consumption of your host application in mA (0...5000). This information enables TC65 to correctly determine the end of charging and terminate charging automatically when the battery is fully charged. Note that if <current> is inaccurate, and the application draws a current higher than the final charge current, either charging will not be terminated or the battery fails to reach its maximum voltage. Therefore, the termination condition is defined as: final charge current (TBD) plus current consumption of the external application. If used, the current flowing over the VEXT pin of the application interface (typically 2.9V) must be added, too. By factory default, a value of 200mA is set, assuming an estimated average current consumption of a typical external application.

The specified value will also be displayed as parameter <mpc> of the AT^SBC read command.

When the TC65 is powered down or reset, the value of <current> is restored to its default. This affects the charging control and disables the presentation of Unsolicited Result Codes. Therefore, the parameter should be set every time when needed after rebooting the TC65.

Notes

- If multiplex mode ([AT+CMUX](#)) is active, any virtual channel can be used for entering the read or write command. The undervoltage URC will be issued simultaneously on all three channels.
- The URC "`^SYSSTART CHARGE-ONLY MODE`" is indicated automatically when the module enters this mode (except when autobauding is active). Unlike the undervoltage URC, it cannot be disabled or enabled by the TE.

19.3.1 Responses returned by read command

Responses returned by the [AT^SBC](#) read command vary with the operating mode of the TC65:

- Normal mode: TC65 is switched on by Ignition pin and running in SLEEP, IDLE, TALK or DATA mode. Charger is not connected. The [AT^SBC](#) read command indicates the battery capacity and the current consumption of the application (if value of application was specified before as `<current>`).
- Normal mode + charging: Allows charging while TC65 is switched on by Ignition pin and running in SLEEP, IDLE, TALK or DATA mode. The [AT^SBC](#) read command returns only charger status and current consumption of the application. Percentage of battery capacity is not available.
- Charge-only mode: Allows charging while TC65 is detached from GSM network. When started, the mode is indicated by the URC "`^SYSSTART CHARGE-ONLY MODE`". The [AT^SBC](#) read command returns only the charger status and current consumption of the application. Percentage of battery capacity is not available. In Charge-only mode a limited number of AT commands is accessible (see Appendix). There are several ways to activate the Charge-only mode:
 - from Power Down mode: Connect charger while the TC65 was powered down with [AT^SMSO](#)
 - from Normal mode: Connect charger, then enter [AT^SMSO](#).

19.4 AT^SBV Battery/Supply Voltage

The `AT^SBV` execute command allows to monitor the supply (or battery) voltage of the module. The voltage is continuously measured at intervals depending on the operating mode of the RF interface. The duration of a measurement period ranges from 0.5s in TALK / DATA mode up to 50s when TC65 is in IDLE mode or Limited Service (deregistered). The displayed value is averaged over the last measuring period before the `AT^SBV` command was executed.

The measurement is related to the reference points of BATT+ and GND, both accessible on a capacitor located close to the module's board-to-board connector. For details please refer to the Hardware Interface Description [2].

Syntax

<p>Test Command</p> <pre>AT^SBV=?</pre> <p>Response(s)</p> <pre>OK ERROR +CME ERROR:</pre>	<p>Exec Command</p> <pre>AT^SBV</pre> <p>Response(s)</p> <pre>^SBV: <value> OK ERROR +CME ERROR:</pre>
<p>Reference(s)</p> <p>SIEMENS</p>	

PIN	ASC0	ASC1	USB	MUX1	MUX2	MUX3	Charge	→	Last
<input type="radio"/>	<input checked="" type="radio"/>	<input checked="" type="radio"/>	<input checked="" type="radio"/>	<input checked="" type="radio"/>	<input checked="" type="radio"/>	<input checked="" type="radio"/>	<input checked="" type="radio"/>	<input type="radio"/>	<input checked="" type="radio"/>

Parameter Description

`<value>`^(num)
Supply (or battery) voltage in mV

19.5 AT^SCTM Set critical operating temperature presentation mode or query temperature

Use this command to monitor the temperature range of the module and the battery. The write command enables or disables the presentation of URCs to report critical temperature limits.

CAUTION: During the first 15 seconds after start-up, the module operates in an automatic report mode: URCs can be always displayed regardless of the selected mode [<n>](#).

Syntax

<p>Test Command</p> <p>AT^SCTM=?</p> <p>Response(s)</p> <p>^SCTM: (list of supported <n>s)</p> <p>OK</p>	
<p>Read Command</p> <p>AT^SCTM?</p> <p>Response(s)</p> <p>^SCTM: <n>, <m></p> <p>OK</p> <p>ERROR</p> <p>+CME ERROR</p>	
<p>Write Command</p> <p>AT^SCTM=<n></p> <p>Response(s)</p> <p>OK</p> <p>ERROR</p> <p>+CME ERROR</p>	
<p>Reference(s)</p> <p>SIEMENS</p>	<p>PIN ASC0 ASC1 USB MUX1 MUX2 MUX3 Charge ↗ Last</p> <p>○ ● ● ● ● ● ● ● ● ○</p>

Unsolicited Result Codes

URC 1

URCs will be automatically sent to the TA when the temperature reaches or exceeds the critical level, or when it is back to normal.

^SCTM_A: [<m>](#)

for battery temperature

URC 2

^SCTM_B: [<m>](#)

for module (board) temperature

Command Description

The read command returns:

- the URC presentation mode
- information about the current temperature range of the module

Please note that the Read command does not indicate the temperature range of the battery. The battery temperature can only be reported by an Unsolicited Result Code.

Select `<n>` to enable or disable the presentation of the URCs. Please note that the setting will not be stored upon Power Down, i.e. after restart or reset, the default `<n>=0` will be restored. To benefit from the URCs `<n>=1` needs to be selected every time you reboot the GSM engine.

Parameter Description

<code><n></code> ^(num)	
0(&F)(P)	Presentation of URCs is disabled (except for <code><m></code> equal to -2 or +2).
1	Presentation of URCs is enabled.

<code><m></code> ^(num)	
-2	Below lowest temperature limit (causes immediate switch-off)
-1	Below low temperature alert limit
0	Normal operating temperature
1	Above upper temperature alert limit
2	Above uppermost temperature limit (causes immediate switch-off)

Notes

- Please refer to the "Hardware Interface Description" for specifications on critical temperature ranges.
- To avoid damage the module will shut down once the critical temperature is exceeded. The procedure is equivalent to the power-down initiated with `AT^SMSO`.
- URCs indicating the alert level "1" or "-1" are intended to enable the user to take appropriate precautions, such as protect the module and the battery from exposure to extreme conditions, or save or back up data etc. The presentation of "1" or "-1" URCs depends on the settings selected with the write command:
If `<n>=0`: Presentation is enabled for 15 s time after the module was switched on. After 15 s operation, the presentation will be disabled, i.e. no URCs will be generated.
If `<n>= 1`: Presentation of "1" or "-1" URCs is always enabled.
- Level "2" or "-2" URCs are followed by immediate shutdown. The presentation of these URCs is always enabled, i.e. they will be output even though the factory setting `AT^SCTM=0` was never changed.
- If the temperature limit is exceeded while an emergency call is in progress the engine continues to measure the temperature and to deliver alert messages, but deactivates the shutdown functionality. Once the call is terminated full temperature control will be resumed. If the temperature is still out of range ME switches off immediately.

Examples

EXAMPLE 1

URCs issued when the operating temperature is out of range:

<code>^SCTM_A: 1</code>	Caution: Battery close to overtemperature limit.
<code>^SCTM_A: 2</code>	Alert: Battery above overtemperature limit. Engine switches off.
<code>^SCTM_B: 1</code>	Caution: Engine close to overtemperature limit.
<code>^SCTM_B: 2</code>	Alert: Engine is above overtemperature limit and switches off.
<code>^SCTM_A: -1</code>	Caution: Battery close to undertemperature limit.
<code>^SCTM_A: -2</code>	Alert: Battery below undertemperature limit. Engine switches off.
<code>^SCTM_B: -1</code>	Caution: Engine close to undertemperature limit.
<code>^SCTM_B: -2</code>	Alert: Engine is below undertemperature limit and switches off.

EXAMPLE 2

URCs issued when the temperature is back to normal (URC is output once):

^SCTM_A: 0	Battery temperature back to normal temperature.
^SCTM_B: 0	Engine back to normal temperature.

19.6 AT^SSYNC Configure SYNC Pin

The `AT^SSYNC` command serves to configure the SYNC pin of the application interface. Please note that the SYNC pin may be assigned different functions: Depending on the design of the host application, the pin can either be used to indicate the current consumption in a transmit burst or to drive a status LED connected to the pin as specified in [2]. For detailed information on the SYNC pin and its LED functionality refer to [2]. Before changing the mode of the SYNC pin, carefully read the technical specifications.

Syntax

<p>Test Command</p> <pre>AT^SSYNC=?</pre> <p>Response(s)</p> <pre>^SSYNC: list of supported <mode>s OK</pre>	
<p>Read Command</p> <pre>AT^SSYNC?</pre> <p>Response(s)</p> <pre>^SSYNC: <mode> OK</pre>	
<p>Write Command</p> <pre>AT^SSYNC=<mode></pre> <p>Response(s)</p> <pre>OK</pre>	
<p>Reference(s)</p> <p>SIEMENS</p>	

Parameter Description

<code><mode></code> ^(num)	
Operation mode of the SYNC pin. Setting is stored non-volatile.	
0 ^(D)	<p>SYNC mode: Enables the SYNC pin to indicate growing power consumption during a transmit burst. You can make use of the signal generated by the SYNC pin, if power consumption is your concern. To do so, ensure that your application is capable of processing the signal. Your platform design must be such that the incoming signal causes other components to draw less current. In short, this allows your application to accommodate current drain and thus, supply sufficient current to the GSM engine if required.</p>
1	<p>LED mode: Enables the SYNC pin to drive a status LED installed in your application according to the specifications provided in [2]. The coding of the LED is described in Section 19.6.1, ME status indicated by status LED patterns.</p>
2	<p>LED mode: Like <code><mode>=1</code>, but, additionally, enables different LED signalization in SLEEP mode depending on the status of PIN authentication and network registration. Please see AT+CFUN for details on SLEEP mode.</p>

19.6.1 ME status indicated by status LED patterns

The following table lists the possible patterns of status LED behavior, and describes the ME operating status indicated by each pattern if `AT^SSYNC` parameter `<mode>=1` and `<mode>=2`.

Table 19.1: Modes of the LED and indicated ME functions

LED behavior	ME operating status if <code>AT^SSYNC=1</code>	ME operating status if <code>AT^SSYNC=2</code>
Permanently off	ME is in one of the following modes: POWER DOWN mode, AIRPLANE mode, CHARGE-ONLY mode, SLEEP mode with no wake-up event in progress.	ME is in one of the following modes: POWER DOWN mode, AIRPLANE mode, CHARGE-ONLY mode.
600 ms on / 600ms off	Limited Network Service: No SIM card inserted or no PIN entered, or network search in progress, or ongoing user authentication, or network login in progress. This applies no matter whether the ME works at full functionality level <code>AT+CFUN=1</code> or has entered a "temporary wake-up state" during one of the CYCLIC SLEEP modes.	Same as for <code>AT^SSYNC=1</code>
75 ms on / 3 s off	IDLE mode: The mobile is registered to the GSM network (monitoring control channels and user interactions). No call is in progress. The same LED pattern applies when the ME enters a "temporary wake-up state" during one of the CYCLIC SLEEP modes (e.g. after characters have been received on the serial interface).	Same as for <code>AT^SSYNC=1</code>
75 ms on / 75 ms off / 75 ms on / 3 s off	One or more GPRS contexts activated.	Same as for <code>AT^SSYNC=1</code>
500 ms on / 25 ms off	Packet switched data transfer in progress.	Same as for <code>AT^SSYNC=1</code>
Permanently on	Depending on type of call: Voice call: Connected to remote party. Data call: Connected to remote party or exchange of parameters while setting up or disconnecting a call. This applies no matter whether the ME works at full functionality level <code>AT+CFUN=1</code> or in of the CYCLIC SLEEP modes where it wakes up only temporarily to make the call.	Same as for <code>AT^SSYNC=1</code>
n * 600 ms on / n * 600 ms off	Not possible: With <code>AT^SSYNC=1</code> , LED signalization is disabled in SLEEP mode.	SLEEP mode is activated (<code>AT+CFUN</code> parameter <code><fun> ≠ 1</code>), but the ME is not registered to the GSM network (e.g. SIM not inserted or PIN not entered, and therefore, either no network service or only Limited Network Service is available).

LED behavior	ME operating status if AT^SSYNC=1	ME operating status if AT^SSYNC=2
n * 75 ms on / n * 3 ms off	Not possible: With AT^SSYNC=1, LED signalization is disabled in SLEEP mode.	SLEEP mode is activated (AT+CFUN parameter <fun> ≠ 1) while the ME is registered to the GSM network.
n * 500 ms on / n * 25 ms off	Not possible: With AT^SSYNC=1, LED signalization is disabled in SLEEP mode.	SLEEP mode is activated (AT+CFUN parameter <fun> ≠ 1) while the ME is registered to the GSM network. Additionally, PDP context is activated.

Note: When the ME is in Limited Service or IDLE mode with/without PDP context activated, the on/off time ratio of the LED is always the same, no matter whether or not power saving is enabled. The only difference is that in SLEEP mode the duration of the on/off periods is a multiple n of the equivalent periods without SLEEP mode. The multiple n is synchronous to the active state of CTS during SLEEP mode (where CTS is set/reset every 0.9 - 2.7 seconds. See also AT+CFUN for the timing of CTS.

19.7 AT^SSPI Serial Protocol Interface

The `AT^SSPI` command enables the module to be connected to external I²C or SPI devices. The I²C/SPI data-stream is mapped through an internal I²C/SPI driver to and from an ASCII hex protocol which can be exchanged with an internal application (JAVA) or an external application via V24.

The `AT^SSPI` write command configures and activates the I²C/SPI interface and changes from command mode into data mode. All values must be given in hexadecimal format (0 - 9, A - F) without "0x". For details on data mode please refer to Section 19.7.3, [Transmitting data over AT interface](#).

Syntax

Test Command

```
AT^SSPI=?
```

Response(s)

```
^SSPI:(list of supported <basicConfiguration>s), (list of supported <delayOne>s), (list of supported <delayTwo>s), (list of supported <frameLength>s), (list of supported <extendedSpiConfiguration>s)
```

OK

Read Command

```
AT^SSPI?
```

Response(s)

```
^SSPI: <basicConfiguration>[, <delayOne>[, <delayTwo>[, <frameLength>[, <extendedSpiConfiguration>]]]]
```

OK
ERROR
+CME ERROR: <err>

Write Command

```
AT^SSPI=<basicConfiguration>[, <delayOne>[, <delayTwo>]][, <frameLength>[, <extendedSpiConfiguration>]
```

Response(s)

OK
ERROR
+CME ERROR: <err>

Reference(s)

SIEMENS

PIN	ASC0	ASC1	USB	MUX1	MUX2	MUX3	Charge	→	Last
○	●	●	●	●	●	●	○	●	●

Parameter Description

`<basicConfiguration>`^(num)

Parameter `<basicConfiguration>` is a 16 bit word which contains four subparameters to control the following functions:

Subparameter	Bit	Hexadecimal	Selected function
Interface type	D15 - D12	0	I ² C bus
		1	SPI device
Port	D11 - D8	0	Internal port (value is required but cannot be changed).

Subparameter	Bit	Hexadecimal	Selected function
Data transfer rate	D7 - D4	0	I ² C at 100 kbps
		1	I ² C at 400 kbps
		2	SPI at 6.5 Mbps (factor 1 - maximum)
		3	SPI at 3.25 Mbps (factor 2)
		4	SPI at 2.167 Mbps (factor 3)
		5	SPI at 1.625 Mbps (factor 4)
		6	SPI at 1.3 Mbps (factor 5)
		7	SPI at 1.083 Mbps (factor 6)
		8	SPI at 929 kbps (factor 7)
		9	SPI at 812 kbps (factor 8)
		A	SPI at 722 kbps (factor 9)
		B	SPI at 650 kbps (factor 10)
		C	SPI at 500 kbps (factor 13)
		D	SPI at 250 kbps (factor 26)
		E	SPI at 100 kbps (factor 65)
F	Reserved		
Protocol	D3 - D0	0	ASCII (hex coding)

<delayOne>^(num)

On the I²C interface, number of ticks to cause a delay after a write frame.
On the SPI bus, number of ticks to cause a delay between CS enable/disable and data transfer. See Section 19.7.1, [Specifying delay time](#) for further details.

[0]...FFFF (Unsigned 16 bit value)

<delayTwo>^(num)

On the I²C interface, number of ticks to cause a delay after a read frame.
On the SPI bus, number of ticks to cause a delay after CS disable. See Section 19.7.1, [Specifying delay time](#) for further details.

[0]...FFFF (Unsigned 16 bit value)

<frameLength>^(num)

8	Length of SPI frame
16	Length of SPI frame
32	Length of SPI frame

<extendedSpiConfiguration>^(num)

Parameter <extendedSpiConfiguration> is a 16 bit word which contains four subparameters to control the following functions:

Subparameter	Bit	Hexadecimal	Selected function
Clock mode	D11 - D8	0	Four SPI modes each with different phase and polarity.
		1	
		2	
		3	
Chip Select (CS) mode	D15 - D12	0	
		1	
		2	
		3	

Subparameter	Bit	Hexadecimal	Selected function
Arrangement of bytes	D7 - D4	0	Big endian
		1	Little endian
Bit sequence (arrangement of bits on the SPI)	D3 - D0	0	MSB first
		1	LSB first

19.7.1 Specifying delay time

The following figures are provided to assist you in specifying appropriate values for the parameters `<delayOne>` and `<delayTwo>`. All delays are relative to the baudrate (delay in ticks). To calculate the delay use the following formula. The so called FSM clock is 13 MHz. From this follows, that one tick is about 77 ns. For the default values please refer to the parameter description above.

$$Delay = \left\{ \frac{1}{FSM\ clock * delay\ value} + default\ delay \right\} * \frac{default\ baudrate}{user\ baudrate}$$

Figure 19.1: Formula to calculate delay

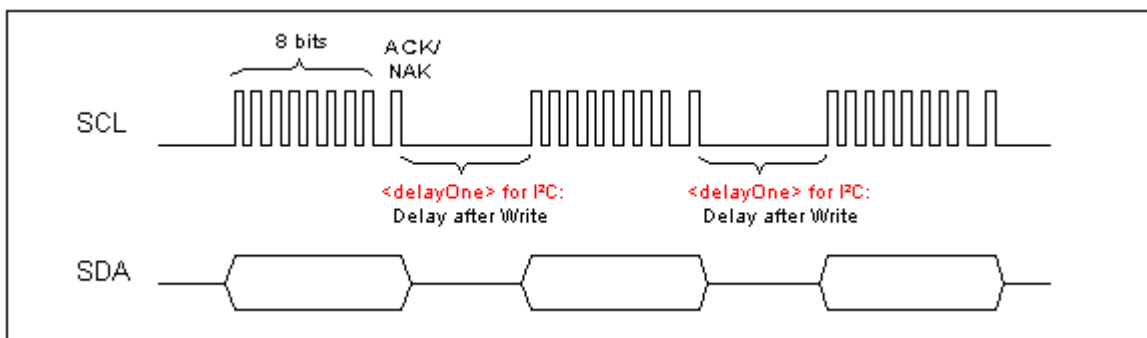

Figure 19.2: Delay time on I²C after Write

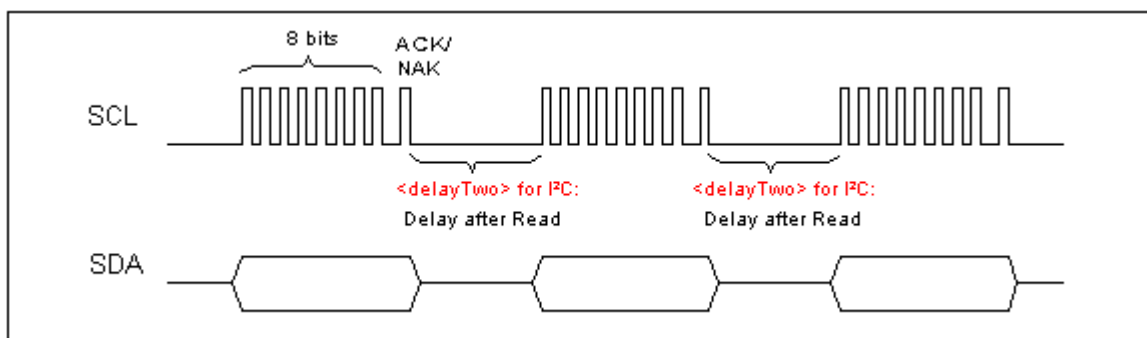

Figure 19.3: Delay time on I²C after Read

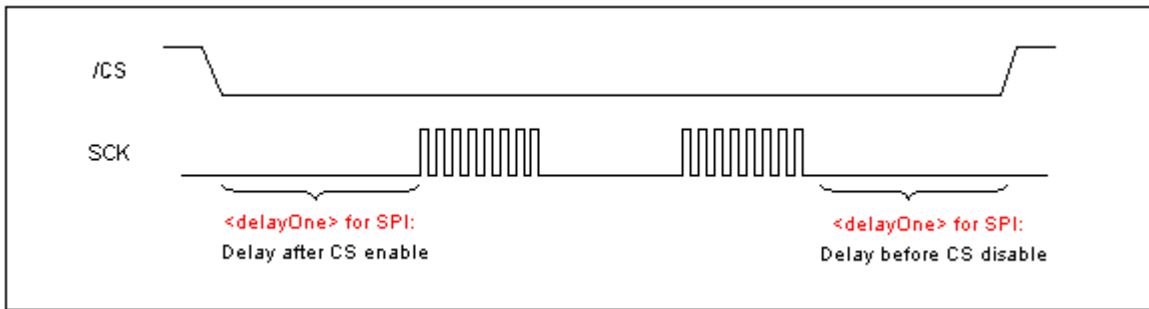

Figure 19.4: Delay time on SPI after/before CS enable/disable

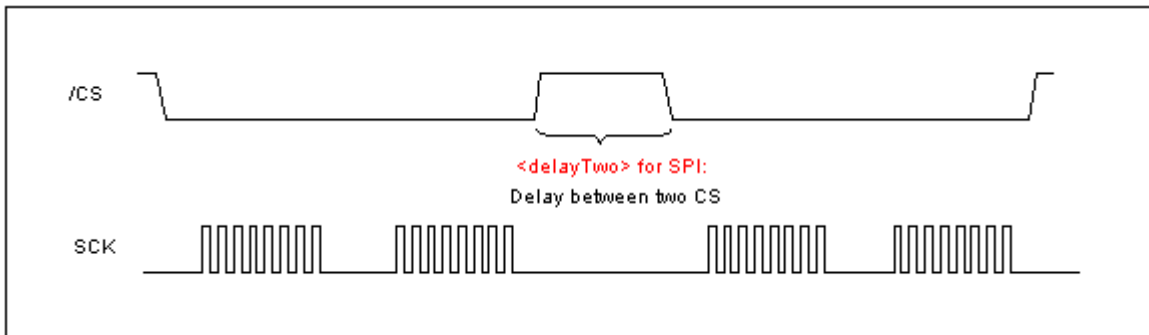

Figure 19.5: Delay time between two CS on SPI

19.7.2 Selecting clock mode on SPI

The figure shows the four types of clock mode selectable by setting the appropriate hexadecimal value within the parameter [<extendedSpiConfiguration>](#).

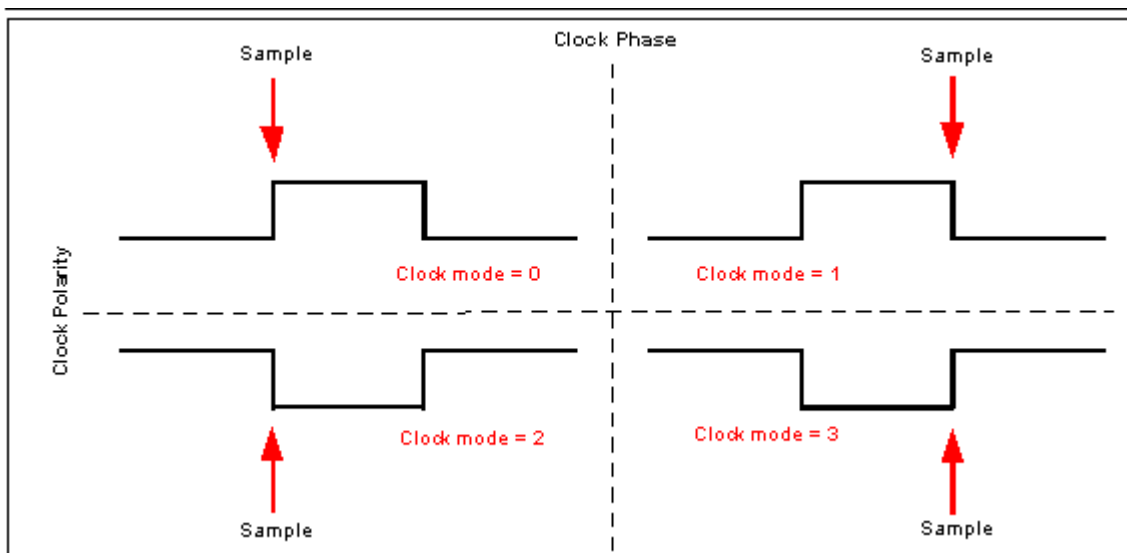

Figure 19.6: Clock modes selectable on SPI

19.7.3 Transmitting data over AT interface

This section provides information on the protocol used for data transmission to or from I²C/SPI devices and explains the data mode. It is assumed that you are familiar with the I²C specification.

Throughout this section the following document conventions are used to mark the direction of send and receive:

Transfer: AT → I²C or SPI device driver

Response: AT ← I²C or SPI device driver

Channel Open / Close:

To change from command mode to data mode use the AT^SSPI write command. To close down the channel send the ASCII code # (0x23).

ASCII Protocol for I²C or SPI communication over AT interface:

The protocol allows using a Terminal program for the communication between the module and the I²C slave device/SPI device. To visualize transferred characters and response data it is recommended to run the Terminal program in chat mode or to switch on local echo.

For transfer and response, special characters are defined, such as Start and Stop to mark a single message and Close to disconnect the data channel. The I²C bus additionally uses the characters ACK/NAK for the Response Message. All valid special characters are listed below:

Table 19.2: Special characters for ASCII coding

Direction AT - Driver	Function in protocol	Special character	Hex value	Use
→	Start Transfer Frame	<	0x3C	Special character sent to the I ² C/SPI driver to start sending.
→	Stop Transfer Frame	>	0x3E	Special character sent to the I ² C/SPI driver to stop sending.
←	Start Response Frame	{	0x7B	
←	Stop Response Frame	}	0x7D	
→	Channel Close	#	0x23	For signalling. Channel Close can be sent any time inside or outside a transmit or receive message. Causes the transfer to be aborted and takes the ME back to AT command mode.
←	ACK (address or data)	+	0x2B	On I ² C only: Special character sent to the I ² C driver. Reports the result of the error analysis found by the driver to the AT interface.
←	NAK (address or data)	-	0x2D	On I ² C only: Special character sent to the I ² C driver. Reports the result of the error analysis found by the I ² C driver to the AT interface. NAK identifies the faulty data byte (16 bit byte counter).
←	Protocol error	!	0x21	For signalling. Reports to the AT interface that the Transfer Frame does not comply with the protocol definition.

Data syntax:

In data mode, any Terminal program can be used to enter data. The following syntax requirements must be met for data input:

- Hex (0...9, a...f, A...F)
- Without "0x" (0x01 →01)
- Each hex value consists of 2 characters (1 →01)
- Without delimiters such as comma, semicolon, space etc. (0xAE 0x01 0xA5 →AE01A5)
- If the number of characters for I²C Slave Address and written date between the special characters "<" and ">" is odd, then a protocol error is reported.

Frame structure:

Write data are packed into a Transfer Frame. Read data are packed into a Response Frame. The Transfer Frame contains a Transmit or Receive Request for the I²C/SPI master.

The first element of each Frame is the start character ("<" for Transfer, "{" for the Response). The second element is the Message ID (1 character). The Message ID serves the user to distinguish between different messages. It is only relevant on protocol level (between AT interface and I²C/SPI device driver), i.e. it is not sent to the I²C slave device or SPI device. The value range of the Message ID comprises the first 128 ASCII characters (ASCII: "NUL" to "DEL", Hex: 0x00 to 0x7F).

In the case of I²C, the third element of the Transfer Frame is the I²C Slave Address (2 characters) identifying each single device connected to the I²C bus. In the case of SPI there is no need for an address, as the connection between the device and the interface is peer-to-peer. The eighth bit of the I²C Slave Address byte is the LSB that determines the direction of the message. If the LSB is "0" the master will write information to the selected slave. If the LSB is "1" the master will read information sent from the slave.

In the case of SPI, the direction of the message (Read or Write) is determined by the LSB of the second byte (below referred to as R/W).

In a Read Transfer Frame on the I²C bus, the size of the expected data must be specified explicitly. This is an element of 4 characters stating the number of bytes to be read. It must be placed after the I²C Slave Address.

Each transfer to the device is followed by a response sent to the AT interface. The response includes a Message ID to identify the frame and either OK ("+") or error characters ("- " or "!"). A successful response to a Read Message contains the OK character and the read data. If an error occurs on the I²C bus, the response consists of an error character followed by a 16 bit code specifying the faulty byte.

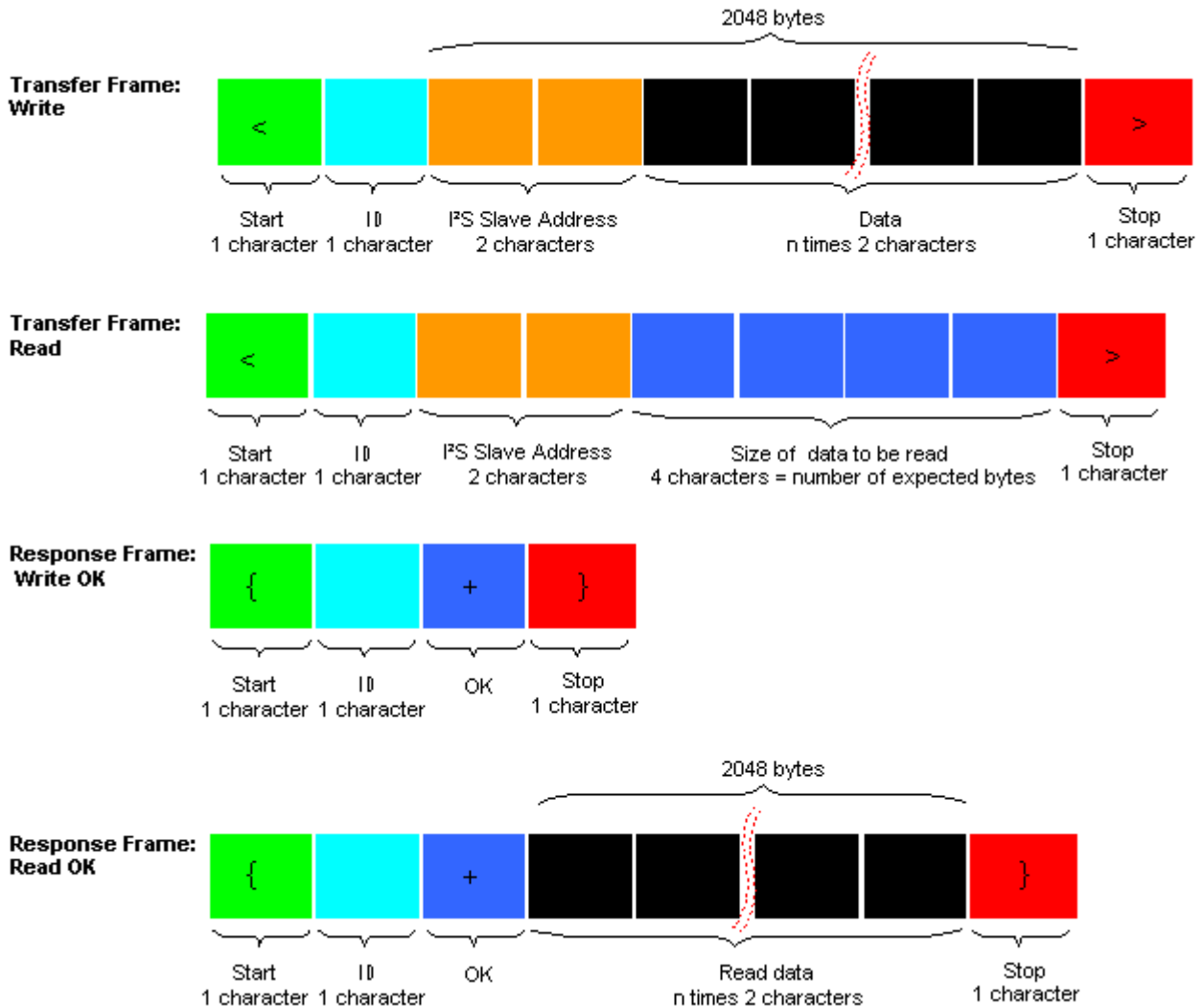

Figure 19.7: Number of characters in I²C Transfer and Response Frames

Table 19.3: Structure of a Transfer Frame on the I²C bus

Function	Format
Write Transfer	< ID SlaveAddress Data > Maximum length: 2048 bytes for I ² C Slave Address and written data. LSB = "0".
Read Transfer (read x bytes)	< ID SlaveAddress xxxx > Maximum length: 2048 bytes for read data. LSB = "1".
Response Write OK Read of x bytes OK NAK for x th Byte if Read or Write Protocol error in x th Byte	{ID + } {ID + Data } {ID - xxxx } {ID ! xxxx }

Table 19.4: Structure of a Transfer Frame for SPI

Function	Format
Write Transfer	< ID R/W Data > Maximum length: 2048 bytes including data. LSB of R/W byte = "0".
Read Transfer (read x bytes)	< ID xxxx > Maximum length: 2048 bytes including data. LSB of R/W byte = "1".
Response Write OK Read of x bytes OK Protocol error in x th Byte	{ID} {ID Data } {ID xxxx }

19.7.4 Error handling on the I²C bus

Acknowledge:

Once a transmission has completed successfully (Write or Read), the special character "+" (ACK) is included in the Response sent to the AT interface.

During a Write Transfer, the I²C driver acknowledges each transferred byte, but the Response contains only one ACK which is transmitted only if all bytes are successfully transferred. During a Read Transfer, an ACK is sent when the I²C slave device notifies that it has recognized the I²C Slave Address.

Not Acknowledge:

During a Transmit Transfer, a NAK is given when the I²C Slave Device notifies a failure to receive either the I²C Slave Address or a data byte. In this case, a Stop Condition is sent to the I²C device.

During a Receive Transfer, a NAK is transmitted only when the I²C does not receive any reponse for the I²C Slave Address. The I²C device never acknowledges the validity of the received data (by sending an ACK the master acknowledges each received byte to the slave).

Protocol error:

If a protocol error is detected the ASCII value "!" is sent to the AT interface. Also, a Stop Condition is sent to the I²C device.

A protocol error occurs if

- any characters do not equal 0...9, a...f and A...F
- the length of a read word is smaller or greater than 16 bits
- the number of ASCII data is odd (e.g. "af1" instead of "af01")
- the Read or Write request is greater than 2 KB (0x0800).

19.7.5 Example: Using I²C bus

As stated above, it is recommended to run the Terminal program in chat mode or to use the local echo. First, activate the I²C interface:

```
AT^SSPI=0010,0,0,0,0000  
OK
```

The first group of characters forms the the [<basic-Configuration>](#), where the first "0" sets I²C, the second "0" is the internal port, the digit "1" sets 400 kbps bit rate on the I²C bus, and the next "0" selects ASCII coding. This is followed by a comma and the value "0" = no delay time after Write and Read. All remaining digits are not relevant for I²C and shall equal "0".

The module is in data mode now. This allows you to send a Write Transfer Frame:

```
<aAE000102030405060708090A0B0C0D0E0F>  
{a+}  
<bAF0010;>  
{b+000102030405060708090A0B0C0D0E0F}
```

Write Transfer Frame, where a = ID, AE = write request.

Write Response Frame, where a = ID.

Read Transfer Frame, where b = ID, AF = read request, 0010 = number of expected bytes.

Read Response Frame, where b = ID.

20. AT Commands for Handling Java Applications

This chapter describes all the AT commands needed to control Java applications running on top of the TC65 module.

20.1 AT^SJRA Run Java Application

The [AT^SJRA](#) write command launches the Java application.

Syntax

Test Command	
AT^SJRA=?	
Response(s)	
OK	
Write Command	
AT^SJRA=<appName>	
Response(s)	
^SJRA:	
OK	
If not successful:	
ERROR	
+CME ERROR: <err>	
Reference(s)	
SIEMENS	
	PIN ASC0 ASC1 USB MUX1 MUX2 MUX3 Charge → Last
	<input type="radio"/> <input checked="" type="radio"/> <input checked="" type="radio"/> <input checked="" type="radio"/> <input checked="" type="radio"/> <input checked="" type="radio"/> <input checked="" type="radio"/> <input checked="" type="radio"/> <input type="radio"/> <input checked="" type="radio"/> <input type="radio"/>

Parameter Description

<appName>^(str)
Path of the Java application
The application name must be given as a fully qualified pathname (a:/.../...) to the jar/jad file containing the desired application.
The local flash file system is identified by: A:. Directory separator is "/" (002Fh).
Example: A:/java/jam/example/helloworld/helloworld.jar

Notes

- As an alternative, the Java application can be enabled to start up automatically whenever TC65 is getting started. Use the [AT^SCFG](#) command to make all the settings need for the Java autostart mode.
- When the Java application starts, all current calls will be terminated.

20.2 AT^SJNET Set Dialup Network Access Parameters

The [AT^SJNET](#) write command allows to create a profile which contains all parameters needed for automated network access through a dialup connection.

Syntax

<p>Test Command</p> <pre>AT^SJNET=?</pre> <p>Response(s)</p> <pre>^SJNET: ("csd" "gprs"), ("Tel. num." "access point name"), ("login"), ("password"), ("dns"), (list of supported <timeout>s) OK</pre>	<p>Write Command</p> <pre>AT^SJNET=<bearer service>, <entry point>, <login>, <password>[, <dns>[, <timeout>]]</pre> <p>Response(s)</p> <pre>^SJNET: <bearer service>, <entry point>, <login>, <password>, <dns>, <timeout> OK ERROR +CME ERROR: <err></pre>
<p>Reference(s)</p> <p>SIEMENS</p>	

Parameter Description

<p><bearer service>^{(str)(+CSCS)}</p> <p>""(P) No bearer specified</p> <p>"csd" Dialup access uses Circuit Switched Data connection</p> <p>"gprs" Dialup access via GPRS</p>
<p><entry point>^{(str)(+CSCS)}</p> <p>If <bearer service> is "csd", then parameter specifies the dialup telephone number. If <bearer service> is "gprs", then parameter specifies the GPRS access point identifier. Parameter is global for all interfaces, volatile and will not be reset by AT&F.</p> <p>""(P)</p>
<p><login>^{(str)(+CSCS)}</p> <p>Parameter specifies the login name for access to the dialup network. Parameter is global for all interfaces, volatile and will not be reset by AT&F.</p> <p>""(P)</p>
<p><password>^{(str)(+CSCS)}</p> <p>Parameter specifies the password for access to the dialup network. Parameter is global for all interfaces, volatile and will not be reset by AT&F.</p> <p>""(P)</p>

<dns>^{(str)(+CSCS)}

Parameter specifies the Primary DNS server (Nameserver) for the dialup network. The server address has to be specified in dotted IP address format (e.g. 145.146.147.148). If parameter is omitted, then it will be assumed, that a name server is not available.

Parameter is global for all interfaces, volatile and will not be reset by [AT&F](#).

“(P)

<timeout>^(num)

Idle Timeout in seconds

Parameter specifies the Java network idle timeout, which is the number of seconds to wait before the network connection is terminated automatically when no data transfer or other network activities take place. The value 0 means no timeout at all (you have to terminate a Circuit Switched Data connection using [ATH](#) and a GPRS connection using [AT+CGACT=0](#)).

We recommend to use values greater than 10 seconds because otherwise you may get unintentional timeouts for slow network connections.

Parameter is global for all interfaces, volatile and will not be reset by [AT&F](#).

0^(P)...[30]...21600

Example

This example illustrates how to configure a profile for circuit switched network access: The dialup phone number is +49800654321, user name is "user1", password is "dialup123", and the primary DNS has IP address "145.146.147.148".

```
AT^SJNET="CSD", "+49800654321", "user1", "dialup123", "145.146.147.148"  
^SJNET: "csd", "+49800654321", "user1", "dialup123", "145.146.147.148", 30  
OK
```

20.3 AT^SJOTAP Over The Air Application Provisioning

The `AT^SJOTAP` command serves to control and start OTAP operations for installing and updating Java applications over the air. Detailed explanations can be found in [3].

The `AT^SJOTAP` write command sets the password and all parameters required to install / delete a Java Application.

The `AT^SJOTAP` execute command starts the OTAP install process.

Syntax

<p>Test Command</p> <pre>AT^SJOTAP=?</pre> <p>Response(s)</p> <pre>^SJOTAP:<SMS_pwd>, <Jad_URL>, <Appl_Dir>, <HTTP_User>, <HTTP_Pwd>, <BS>, <Dest>, <Net_user>, <Net_pwd>, <DNS>, <NotifyURL></pre> <p>OK</p>																					
<p>Read Command</p> <pre>AT^SJOTAP?</pre> <p>Response(s)</p> <pre>^SJOTAP: <SMS_pwd>, <Jad_URL>, <Appl_Dir>, <HTTP_User>, <HTTP_Pwd>, <BS>, <Dest>, <Net_user>, <Net_pwd>, <DNS>, <NotifyURL></pre> <p>OK</p> <p>ERROR</p> <p>+CME ERROR: <err></p>																					
<p>Exec Command</p> <pre>AT^SJOTAP</pre> <p>Response(s)</p> <p>OK</p> <p>ERROR</p> <p>+CME ERROR: <err></p>																					
<p>Write Command</p> <pre>AT^SJOTAP=[<SMS_pwd>][, <Jad_URL>][, <Appl_Dir>][, <HTTP_User>][, <HTTP_Pwd>][, <BS>][, <Dest>][, <Net_user>][, <Net_pwd>][, <DNS>][, <NotifyURL>]</pre> <p>Response(s)</p> <p>OK</p> <p>ERROR</p> <p>+CME ERROR: <err></p>																					
<p>Reference(s)</p> <p>SIEMENS</p>	<table border="1"> <thead> <tr> <th>PIN</th> <th>ASC0</th> <th>ASC1</th> <th>USB</th> <th>MUX1</th> <th>MUX2</th> <th>MUX3</th> <th>Charge</th> <th>→</th> <th>Last</th> </tr> </thead> <tbody> <tr> <td>●</td> <td>●</td> <td>●</td> <td>●</td> <td>●</td> <td>●</td> <td>●</td> <td>○</td> <td>○</td> <td>○</td> </tr> </tbody> </table>	PIN	ASC0	ASC1	USB	MUX1	MUX2	MUX3	Charge	→	Last	●	●	●	●	●	●	●	○	○	○
PIN	ASC0	ASC1	USB	MUX1	MUX2	MUX3	Charge	→	Last												
●	●	●	●	●	●	●	○	○	○												

Parameter Description

<p><SMS_pwd>^(str)</p> <p>Password for OTAP SMS authentication</p>
<p><Jad_URL>^(str)</p> <p>URL of update file</p>

<Appl_Dir>^(str)

Directory of Java application

Directory on the ME where a new application (JAD and JAR file) is installed. When entering the application directory with the [AT^SJOTAP](#) write command be sure that the path name is not terminated with a slash. For example, type "a:" or "a:/otap" rather than "a:/" or "a:/otap/".

<HTTP_User>^(str)

HTTP user name

<HTTP_Pwd>^(str)

HTTP password

<BS>^(str)

Bearer Service

"csd" Use Bearer service "Circuit Switched".

"gprs" Use Bearer service "GPRS".

<Dest>^(str)

Destination

Telephone number if <BS>=csd or Access Point name if <BS>=gprs.

<Net_user>^(str)

User name for accessing the network

<Net_pwd>^(str)

Password for accessing the network

<DNS>^(str)

Domain Name Server

<NotifyURL>^(str)

URL to which result codes are posted

Notes

- All parameters which are left out in the write command are set to "not configured", while parameters which are entered as "" will be stored as an empty string.
- Parameters that have not been configured via AT command, can be configured via SMS (see [\[3\]](#)).
- Parameters that have been configured via AT command cannot be reconfigured / overwritten via SMS.
- If the execute command ends up with an error, one or more mandatory parameters have not been specified (see [\[3\]](#)).

21. Miscellaneous Commands

The AT Commands described in this chapter are related to various areas.

21.1 A/ Repeat previous command line

Syntax

Exec Command									
A/									
Response(s)									
Reference(s)									
V.250									
PIN	ASC0	ASC1	USB	MUX1	MUX2	MUX3	Charge	↔	Last
<input type="radio"/>	<input checked="" type="radio"/>	<input checked="" type="radio"/>	<input checked="" type="radio"/>	<input checked="" type="radio"/>	<input checked="" type="radio"/>	<input checked="" type="radio"/>	<input type="radio"/>	<input checked="" type="radio"/>	<input type="radio"/>

Command Description

Repeat previous command line.

Notes

- Line does not need to end with terminating character.
- After beginning with the character "a" or "A" a second character "t", "T" or "/" has to follow. In case of using a wrong second character, it is necessary to start again with character "a" or "A".
- If autobauding is active, the command [A/](#) cannot be used (see [AT+IPR](#)).

21.2 AT3 Set command line termination character

The [AT3](#) command determines the character recognized by the TA to terminate an incoming command line.

Syntax

<p>Read Command</p> <p>AT3?</p> <p>Response(s)</p> <p><n></p> <p>OK</p>																					
<p>Write Command</p> <p>AT3=<n></p> <p>Response(s)</p> <p>OK</p> <p>ERROR</p>																					
<p>Reference(s)</p> <p>V.250</p>	<table border="1"> <tr> <td>PIN</td> <td>ASC0</td> <td>ASC1</td> <td>USB</td> <td>MUX1</td> <td>MUX2</td> <td>MUX3</td> <td>Charge</td> <td>→</td> <td>Last</td> </tr> <tr> <td><input type="radio"/></td> <td><input checked="" type="radio"/></td> <td><input checked="" type="radio"/></td> <td><input checked="" type="radio"/></td> <td><input checked="" type="radio"/></td> <td><input checked="" type="radio"/></td> <td><input checked="" type="radio"/></td> <td><input type="radio"/></td> <td><input checked="" type="radio"/></td> <td><input type="radio"/></td> </tr> </table>	PIN	ASC0	ASC1	USB	MUX1	MUX2	MUX3	Charge	→	Last	<input type="radio"/>	<input checked="" type="radio"/>	<input checked="" type="radio"/>	<input checked="" type="radio"/>	<input checked="" type="radio"/>	<input checked="" type="radio"/>	<input checked="" type="radio"/>	<input type="radio"/>	<input checked="" type="radio"/>	<input type="radio"/>
PIN	ASC0	ASC1	USB	MUX1	MUX2	MUX3	Charge	→	Last												
<input type="radio"/>	<input checked="" type="radio"/>	<input checked="" type="radio"/>	<input checked="" type="radio"/>	<input checked="" type="radio"/>	<input checked="" type="radio"/>	<input checked="" type="radio"/>	<input type="radio"/>	<input checked="" type="radio"/>	<input type="radio"/>												

Parameter Description

<p><n>^{(num)(&W)(&V)}</p> <p>command line termination character</p> <p>000...13^(&F)...127</p>

Notes

- Using a value other than the default 13 may cause problems when entering commands.
- Whenever you change the setting take into account that the new value has no effect on the URC "[^SHUT-DOWN](#)".

21.3 ATS4 Set response formatting character

The [ATS4](#) command determines the character generated by the TA for result code and information text.

Syntax

Read Command	
ATS4?	
Response(s)	
<n>	
OK	
Write Command	
ATS4=<n>	
Response(s)	
OK	
ERROR	
Reference(s)	
V.250	
	PIN ASC0 ASC1 USB MUX1 MUX2 MUX3 Charge → Last
	<input type="radio"/> <input checked="" type="radio"/> <input checked="" type="radio"/> <input checked="" type="radio"/> <input checked="" type="radio"/> <input checked="" type="radio"/> <input checked="" type="radio"/> <input checked="" type="radio"/> <input type="radio"/> <input checked="" type="radio"/> <input type="radio"/>

Parameter Description

<n> ^{(num)(&W)(&V)}
response formatting character
000...10 ^(&F) ...127

Note

- Whenever you change the setting take into account that the new value has no effect on the URC "[^SHUT-DOWN](#)".

21.4 ATS5 Write command line editing character

Syntax

Read Command	
ATS5?	
Response(s)	
<n>	
OK	
Write Command	
ATS5=<n>	
Response(s)	
OK	
ERROR	
Reference(s)	
V.250	

PIN	ASC0	ASC1	USB	MUX1	MUX2	MUX3	Charge	→	Last
<input type="radio"/>	<input checked="" type="radio"/>	<input checked="" type="radio"/>	<input checked="" type="radio"/>	<input checked="" type="radio"/>	<input checked="" type="radio"/>	<input checked="" type="radio"/>	<input type="radio"/>	<input checked="" type="radio"/>	<input type="radio"/>

Command Description

This parameter setting determines the character recognized by TA as a request to delete the immediately preceding character from the command line.

Parameter Description

<n> ^{(num)(&W)(&V)}
command line editing character
000...8 ^(&F) ...127

21.5 AT^SFDL Enter Firmware Download Mode

The `AT^SFDL` command allows the application manufacturer to download TC65 firmware into the module by starting the download process from the host application. The download can be done over the serial interfaces ASC0 or ASC1 or the USB interface.

For this purpose, the TC65 firmware update file must be available in the format *.USF. The file can be requested from Siemens. This manual only describes the handling of the `AT^SFDL` command. All technical requirements and steps to prepare the host application for this download solution can be found in the Application Note "Updating Firmware".

The `AT^SFDL` execute command causes the ME to power down and enter the firmware download mode. If the TC65 firmware file *.?*. is found the download process starts up immediately. If no TC65 firmware is detected the ME switches off after a 7 second timeout. In this case the ME can be restarted by using the IGT line.

Syntax

Test Command	
AT^SFDL=?	
Response(s)	
OK	
Exec Command	
AT^SFDL	
Response(s)	
OK	
Reference(s)	
SIEMENS	

PIN	ASC0	ASC1	USB	MUX1	MUX2	MUX3	Charge	→	Last
<input type="radio"/>	<input checked="" type="radio"/>	<input checked="" type="radio"/>	<input checked="" type="radio"/>	<input type="radio"/>	<input type="radio"/>	<input type="radio"/>	<input type="radio"/>	<input type="radio"/>	<input checked="" type="radio"/>

22. Appendix

22.1 Restricted access to SIM data after SIM PIN authentication

The following commands can be used only after data from the SIM have been read successfully for the first time. Reading starts after successful SIM authentication has been performed, and may take up to 30 seconds depending on the SIM used. While the read process is in progress, an attempt to use any of the following commands will result in "+CME Error: 14" (SIM busy).

We recommend to take advantage of the "^SSIM READY" URC. If enabled with `AT^SSET`, this URC acknowledges to the user that SIM data is accessible after SIM PIN authentication. It will be delivered once the ME has completed reading data from the SIM card.

∅ ... AT Command not available

○ ... AT command accessible immediately after PIN entry has returned OK

● ... AT command fully accessible after SIM PIN authentication has been completed

AT Command	Exec	Test	Read	Write
<code>AT+CMGL</code>	●	○	∅	●
<code>AT^SMGL</code>	●	○	∅	●
<code>AT+CMGR</code>	∅	○	∅	●
<code>AT^SMGR</code>	∅	○	∅	●
<code>AT+CSCA</code>	∅	○	●	○
<code>AT^SSTGI</code>	∅	●	●	●
<code>AT^SSTR</code>	∅	●	●	●
<code>AT+CPBR</code>	∅	●	∅	●
<code>AT+CPBW</code>	∅	●	∅	●
<code>AT+CPBS</code>	∅	●	●	●
<code>AT^SDLD</code>	●	●	∅	∅
<code>AT^SPBC</code>	∅	●	∅	●
<code>AT^SPBD</code>	∅	●	∅	●
<code>AT^SPBG</code>	∅	●	∅	●
<code>AT^SPBS</code>	∅	●	∅	●
<code>ATD<mem><n></code>	●	∅	∅	∅

22.2 Star-Hash (*#) Network Commands

The following command strings can be sent to the network via [ATD](#) and have to be terminated with a semicolon. The command strings are defined with GSM 2.30 [19].

Table 22.1: Star-Hash (*#) Command Overview

Star-Hash Code	Functionality	Response, also refer to Table 22.3
Phone Security		
*#06#	Query IMEI	<IMEI> OK
**04[2]*oldPin[2]*newPin[2]*new-Pin[2]#	Change SIM pwd	+CME ERROR: <err> / OK
**05[2]*unblKey[2]*newPin[2]*new-Pin[2]#	Change/Unblocking SIM pwd	+CME ERROR: <err> / OK
*#0003*MasterPhoneCode#	Unlock "PS" lock with Master Phone Code	+CME ERROR: <err> / OK
[]03*[ZZ]*oldPw*newPw*newPw#	Registration of net password	+CME ERROR: <err> / OK
Phone number presentation		
*#30#	Check status of CLIP (Calling Line Identification Presentation)	+CLIP : <n>,<m> OK (see AT+CLIP)
*#31#	Check status of CLIR (Calling Line Identification Restriction)	+CLIR : <n>,<m> OK (see AT+CLIR)
*31#<Phonenumber>[:]	Suppress CLIR	(see AT+CLIR)
#31#<Phonenumber>[:]	Activate CLIR	(see AT+CLIR)
*#76#	Check status of COLP (Connected Line Identification Presentation)	+COLP : <n>,<m> OK (see: AT+COLP)
*#77#	Check status of COLR (Connected Line Identification Restriction)	+COLR : 0,<m> OK (where <m> = active or not active)
Call forwarding		
(choice of *,#,*,**,##)21*DN*BS#	Act/deact/int/reg/eras CFU	^SCCFC : <reason>, <status>, <class> [...] like +CCFC *) (see: AT+CCFC)
(choice of *,#,*,**,##)67*DN*BS#	Act/deact/int/reg/eras CF busy	see above
(choice of *,#,*,**,##)61*DN*BS*T#	Act/deact/int/reg/eras CF no reply	see above
(choice of *,#,*,**,##)62*DN*BS#	Act/deact/int/reg/eras CF no reach	see above
(choice of *,#,*,**,##)002*DN*BS*T#	Act/deact/int/reg/eras CF all	see above
(choice of *,#,*,**,##)004*DN*BS*T#	Act/deact/int/reg/eras CF all cond.	see above
Call waiting		
(choice of *,#,*,**)43*BS#	Activation/deactivation/int WAIT	+CCWA : <status>, <class> [...] like +CCWA *) (see: AT+CCWA)

Star-Hash Code	Functionality	Response, also refer to Table 22.3
Call barring		
(choice of *,#,*)33*Pw*BS#	Act/deact/int BAOC	^SCLCK : <fac>, <status>, <class> [, ...] like +CLCK *) (Refer to AT+CLCK)
(choice of *,#,*)331*Pw*BS#	Act/deact/int BAOIC	see above
(choice of *,#,*)332*Pw*BS#	Act/deact/int BAOIC exc.home	see above
(choice of *,#,*)35*Pw*BS#	Act/deact/int. BAIC	see above
(choice of *,#,*)351*Pw*BS#	Act/deact/int BAIC roaming	see above
#330*Pw*BS#	Deact. All Barring Services	see above
#333*Pw*BS#	Deact. All Outg.Barring Services	see above
#353*Pw*BS#	Deact. All Inc.Barring Services	see above

Call Hold / Multiparty		
C[C] in call	Call hold and multiparty	+CME ERROR: <err> / OK

USSD messages		
[C]...[C]#	Send USSD message	+CME ERROR: <err> / OK
C[C] (excluded 1[C])	Send USSD message	+CME ERROR: <err> / OK

*) Notes on ^SCCFC, +CCWA, ^SCLCK: The output depends on the affected basic service of the Star-Hash code. One line will be output for every tele- or bearer service coded in basic service code BS.
^SCCFC and ^SCLCK are modified by giving an additional <reason> or <fac> in front of the regular output string generated by the standard commands +CCFC and +CLCK.

Table 22.2: Abbreviations of Codes and Parameters used in Table 22.1

Abbreviation	Meaning	Value
ZZ	Type of supplementary services: Barring services All services	330 Not specified
DN	Dialing number	String of digits 0-9
BS	Basic service equivalent to parameter class: Voice FAX SMS SMS+FAX Data circuit asynchron Data circuit synchron dedicated PAD access dedicated Packet access Data circuit asynchron+PAD Data circuit synchron+Packet Data circuit asynchron+synchron+Packet+PAD All Services	11 13 16 12 25 24 27 26 21 22 20 --
T	Time in seconds	In contrast to AT+CCFC, parameter T has no default value. If T is not specified, an operator defined default or the last known value may be used, depending on the network operator.

Abbreviation	Meaning	Value
PW	Password	--
C	Character of TE character set (e.g. asterics, hash or digit in case of USSD, or digits in case of held calls or multiparty calls)	--

Table 22.3: Star-Hash Command Response Parameters

Parameter	Meaning
<m>	Mode: 0 = not active, 1 = active
<n>	Unsolicited result code: 0 = presentation disabled, 1 = presentation enabled
<status>	Status: 0 = not active, 1 = active
<class>	Represents BS = basic service, refer to AT+CCFC , AT+CLCK
<fac>	Facility lock, refer to AT+CLCK
<reason>	Call forwarding reason

For exact specification of format and parameters for Star-Hash commands refer to GSM 02.04, Table 3.2 [18] and GSM 02.30, Annex C [19].

Table 22.4: Star-Hash Commands for Supplementary Services

Star-Hash Code	Abbreviations in Table 22.1	Functionality
*	act	Activate (except for CLIR, see list above)
**	reg	Register and activate
*#	int	Check status (interrogate)
#	deact	Deactivate (except for CLIR, see list above)
##	eras	Unregister and deactivate

22.3 Available AT Commands and Dependency on SIM PIN

∅ ... Command not available

○ ... Command does not require PIN1

● ... Command requires PIN1

⦿ ... Command sometimes requires PIN1

Table 22.5: Available AT Commands and Dependency on SIM PIN

AT Command	Exec	Test	Read	Write
Configuration Commands				
AT&F	○	∅	∅	∅
AT&V	○	∅	∅	∅
AT&W	○	∅	∅	∅
ATQ	○	∅	∅	∅
ATV	○	∅	∅	∅
ATX	○	∅	∅	∅
AT\V	○	∅	∅	∅
ATZ	○	∅	∅	∅
AT+CFUN	∅	○	○	○
AT^SMSO	○	○	∅	∅
AT+GCAP	○	○	∅	∅
AT+CMEE	∅	○	○	○
AT+CSCS	∅	○	○	○
AT^SCFG	∅	○	○	○
AT^SM20	∅	○	○	○
Status Control Commands				
AT+CMER	∅	○	○	○
AT+CIND	∅	○	○	○
AT^SIND	∅	○	○	○
AT+CEER	●	●	∅	∅
ATS18	∅	∅	○	○
AT+CPAS	○	○	∅	∅
AT+WS46	∅	○	○	○
Serial Interface Control Commands				
AT\Q	○	∅	∅	∅
AT&C	○	∅	∅	∅
AT&D	○	∅	∅	∅
AT&S	○	∅	∅	∅
ATE	○	∅	∅	∅
AT+ICF	∅	○	○	○
AT+IFC	∅	○	○	○

AT Command	Exec	Test	Read	Write
AT+ILRR	∅	●	●	●
AT+IPR	∅	○	○	○
AT+CMUX	∅	○	○	○
AT^STPB	∅	○	○	○
Security Commands				
AT+CPIN	∅	○	○	○
AT+CPIN2	∅	●	●	●
AT^SPIC	○	○	○	○
AT+CLCK	∅	●	∅	●
AT^SLCK	∅	●	∅	●
AT+CPWD	∅	●	∅	●
AT^SPWD	∅	●	∅	●
Identification Commands				
ATI	○	∅	∅	∅
AT+CGMI	○	○	∅	∅
AT+GMI	○	○	∅	∅
AT+CGMM	○	○	∅	∅
AT+GMM	○	○	∅	∅
AT+CGMR	○	○	∅	∅
AT+GMR	○	○	∅	∅
AT+CGSN	○	○	∅	∅
AT+GSN	○	○	∅	∅
AT+CIMI	●	●	∅	∅
Call related Commands				
ATA	●	∅	∅	∅
ATD	●	∅	∅	∅
ATD><mem><n>	●	∅	∅	∅
ATD><n>	●	∅	∅	∅
ATD><str>	●	∅	∅	∅
ATDI	●	∅	∅	∅
ATDL	●	∅	∅	∅
ATH	○	∅	∅	∅
AT+CHUP	●	●	∅	∅
AT^SHUP	∅	●	∅	●
ATS0	∅	∅	○	●
ATS6	∅	∅	○	○
ATS7	∅	∅	○	○
ATS8	∅	∅	○	○
ATS10	∅	∅	○	○
ATO	○	∅	∅	∅

AT Command	Exec	Test	Read	Write
+++	○	∅	∅	∅
AT+CBST	∅	○	○	○
AT+CRLP	∅	○	○	○
AT+CLCC	●	●	∅	∅
AT^SLCC	●	●	●	●
AT+CR	∅	●	●	●
AT+CRC	∅	○	○	○
AT+CSNS	∅	○	○	○
AT^SCNI	●	●	∅	∅
AT^SLCD	●	●	∅	∅
AT^STCD	●	●	∅	∅
ATP	○	∅	∅	∅
ATT	○	∅	∅	∅
Network Service Commands				
AT+COPN	●	●	∅	∅
AT+COPS	∅	○	◐	◐
AT^SOPS	∅	●	∅	∅
AT+CREG	∅	○	○	○
AT+CSQ	○	○	∅	∅
AT^SMONC	●	●	∅	∅
AT^MONI	○	○	∅	○
AT^MONP	○	○	∅	○
AT^SMONG	●	●	∅	●
AT^SALS	∅	●	●	●
AT^SHOM	○	○	∅	∅
AT^SPLM	●	●	●	●
AT^SPLR	∅	●	∅	●
AT^SPLW	∅	●	∅	●
Supplementary Service Commands				
AT+CACM	∅	●	●	●
AT^SACM	●	●	∅	●
AT+CAMM	∅	●	●	●
AT+CAOC	●	●	●	●
AT+CCUG	∅	●	●	●
AT+CCFC	∅	●	∅	●
AT+CCWA	∅	●	●	●
AT+CHLD	∅	●	∅	●
AT+CLIP	∅	○	●	○
AT+CLIR	∅	●	●	●
AT+COLP	∅	●	●	●

AT Command	Exec	Test	Read	Write
AT+CPUC	∅	●	●	●
AT+CSSN	∅	○	○	○
AT+CUSD	∅	●	●	●
Internet Service Commands				
AT^SICS	∅	○	○	○
AT^SISS	∅	○	○	○
AT^SISO	∅	○	○	●
AT^SISC	∅	○	∅	●
AT^SISR	∅	○	∅	●
AT^SISW	∅	○	∅	●
GPRS Commands				
AT+CGACT	∅	●	●	●
AT+CGANS	∅	●	∅	●
AT+CGATT	∅	●	●	●
AT+CGAUTO	∅	●	●	●
AT+CGDATA	∅	●	∅	●
AT+CGDCONT	∅	●	●	●
AT+CGEQMIN	∅	●	●	●
AT+CGEQREQ	∅	●	●	●
AT+CGPADDR	∅	●	∅	●
AT+CGQMIN	∅	●	●	●
AT+CGQREQ	∅	●	●	●
AT+CGREG	∅	●	●	●
AT+CGSMS	∅	●	●	●
AT^SGACT	●	●	●	∅
AT^SGAUTH	∅	○	○	○
AT^SGCONF	∅	○	○	○
ATA	●	∅	∅	∅
ATD*99#	●	∅	∅	∅
ATD*98#	●	∅	∅	∅
ATH	●	∅	∅	∅
ATS0	∅	∅	○	●
FAX Commands				
AT+FCLASS	∅	○	○	○
AT+FRH	∅	∅	∅	○
AT+FRM	∅	○	∅	○
AT+FRS	∅	∅	∅	○
AT+FTH	∅	∅	∅	○
AT+FTM	∅	○	∅	○
AT+FTS	∅	∅	∅	○

AT Command	Exec	Test	Read	Write
Short Message Service (SMS) Commands				
AT+CMGC	∅	●	∅	●
AT+CMGD	∅	●	∅	●
AT+CMGF	∅	○	○	○
AT+CMGL	●	●	∅	●
AT+CMGR	∅	●	∅	●
AT+CMGS	∅	●	∅	●
AT+CMGW	●	●	∅	●
AT+CMSS	∅	●	∅	●
AT+CNMA	●	●	∅	●
AT+CNMI	∅	●	●	●
AT+CPMS	∅	●	●	●
AT+CSCA	∅	●	●	●
AT+CSCB	∅	●	●	●
AT+CSDH	∅	●	●	●
AT+CSMP	∅	●	●	●
AT+CSMS	∅	●	●	●
AT^SCML	●	●	∅	●
AT^SCMR	∅	●	∅	●
AT^SCMS	∅	●	∅	●
AT^SCMW	∅	●	∅	●
AT^SLMS	●	●	∅	∅
AT^SMGL	●	●	∅	●
AT^SMGO	∅	●	●	●
AT^SMGR	∅	●	∅	●
AT^SSCONF	∅	○	○	○
AT^SSDA	∅	○	○	○
AT^SSMSS	∅	○	○	○
SIM related Commands				
AT+CRSM	∅	◐	∅	◐
AT^SXSM	∅	●	∅	●
AT^SCKS	∅	○	○	○
AT^SSET	∅	○	○	○
AT^SCID	○	○	∅	∅
AT+CXXCID	○	○	∅	∅
Remote SIM Access (RSA) Commands				
AT^SRSA	∅	○	○	○
AT^SRSM	∅	○	∅	○

AT Command	Exec	Test	Read	Write
SIM Application Toolkit (SAT) Commands				
AT^SSTA	∅	○	○	○
^SSTN	∅	∅	∅	∅
AT^SSTGI	∅	○	○	○
AT^SSTR	∅	○	○	○
Phonebook Commands				
AT+CPBR	∅	●	∅	●
AT+CPBS	∅	●	●	●
AT+CPBW	∅	●	∅	●
AT^SDLD	●	●	∅	∅
AT^SPBC	∅	●	∅	●
AT^SPBD	∅	●	∅	●
AT^SPBG	∅	●	∅	●
AT^SPBS	∅	●	∅	●
Audio Commands				
ATL	○	∅	∅	∅
ATM	○	∅	∅	∅
AT+CLVL	∅	○	○	○
AT+CMUT	∅	○	○	○
AT+VTD	∅	○	○	○
AT+VTS	∅	○	∅	○
AT^SAIC	∅	○	○	○
AT^SNFA	∅	○	○	○
AT^SNFD	○	○	∅	∅
AT^SNFI	∅	○	○	○
AT^SNFM	∅	○	○	○
AT^SNFO	∅	○	○	○
AT^SNFPT	∅	○	○	○
AT^SNFS	∅	○	○	○
AT^SNFTTY	∅	●	●	●
AT^SNFV	∅	○	○	○
AT^SNFW	○	○	∅	∅
AT^SRTC	○	○	○	○
Hardware related Commands				
AT+CCLK	∅	○	○	○
AT+CALA	∅	○	○	○
AT^SBC	∅	○	○	○
AT^SBV	○	○	∅	∅
AT^SCTM	∅	○	○	○

AT Command	Exec	Test	Read	Write
AT^SSYNC	∅	○	○	○
AT^SSPI	∅	○	○	○
AT Commands for Handling Java Applications				
AT^SJRA	∅	○	∅	○
AT^SJNET	∅	●	∅	●
AT^SJOTAP	●	●	●	●
Miscellaneous Commands				
A/	○	∅	∅	∅
ATS3	∅	∅	○	○
ATS4	∅	∅	○	○
ATS5	∅	∅	○	○
AT^SFDL	○	○	∅	∅

22.4 Availability of AT Commands Depending on Operating Mode of ME

- ... Command not supported
- ... Command supported
- ◐ ... Use in Airplane mode depends on command type (test, read, execute, write).
See description of AT command for details.

Table 22.6: Availability of AT Commands Depending on Operating Mode of ME

AT Command	Normal Mode	→	Charge
Configuration Commands			
AT&F	●	●	○
AT&V	●	●	○
AT&W	●	●	○
ATQ	●	●	○
ATV	●	●	○
ATX	●	●	○
AT\V	●	●	○
ATZ	●	●	○
AT+CFUN	●	●	◐
AT^SMSO	●	●	○
AT+GCAP	●	●	○
AT+CMEE	●	●	○
AT+CSCS	●	●	○
AT^SCFG	●	◐	○
AT^SM20	●	○	○
Status Control Commands			
AT+CMER	●	●	○
AT+CIND	●	●	○
AT^SIND	●	●	○
AT+CEER	●	●	○
ATS18	●	●	○
AT+CPAS	●	●	○
AT+WS46	●	●	○
Serial Interface Control Commands			
AT\Q	●	●	○
AT&C	●	●	○
AT&D	●	●	○
AT&S	●	●	○
ATE	●	●	○
AT+ICF	●	●	○
AT+IFC	●	●	○

AT Command	Normal Mode	✈	Charge
AT+ILRR	●	●	○
AT+IPR	●	●	○
AT+CMUX	●	●	○
AT^STPB	●	●	○
Security Commands			
AT+CPIN	●	●	○
AT+CPIN2	●	●	○
AT^SPIC	●	●	○
AT+CLCK	●	◐	○
AT^SLCK	●	◐	○
AT+CPWD	●	◐	○
AT^SPWD	●	◐	○
Identification Commands			
ATI	●	●	○
AT+CGMI	●	●	○
AT+GMI	●	●	○
AT+CGMM	●	●	○
AT+GMM	●	●	○
AT+CGMR	●	●	○
AT+GMR	●	●	○
AT+CGSN	●	●	○
AT+GSN	●	●	○
AT+CIMI	●	●	○
Call related Commands			
ATA	●	○	○
ATD	●	○	○
ATD><mem><n>	●	○	○
ATD><n>	●	○	○
ATD><str>	●	○	○
ATDI	●	○	○
ATDL	●	○	○
ATH	●	○	○
AT+CHUP	●	○	○
AT^SHUP	●	○	○
ATS0	●	○	○
ATS6	●	●	○
ATS7	●	●	○
ATS8	●	●	○
ATS10	●	●	○

AT Command	Normal Mode	✈	Charge
ATO	●	○	○
+++	●	○	○
AT+CBST	●	●	○
AT+CRLP	●	●	○
AT+CLCC	●	○	○
AT^SLCC	●	○	○
AT+CR	●	●	○
AT+CRC	●	●	○
AT+CSNS	●	●	○
AT^SCNI	●	○	○
AT^SLCD	●	●	○
AT^STCD	●	●	○
ATP	●	○	○
ATT	●	○	○
Network Service Commands			
AT+COPN	●	●	○
AT+COPS	●	○	○
AT^SOPS	●	●	○
AT+CREG	●	○	○
AT+CSQ	●	●	○
AT^SMONC	●	○	○
AT^MONI	●	○	○
AT^MONP	●	○	○
AT^SMONG	●	○	○
AT^SALS	●	○	○
AT^SHOM	●	○	○
AT^SPLM	●	●	○
AT^SPLR	●	●	○
AT^SPLW	●	●	○
Supplementary Service Commands			
AT+CACM	●	●	○
AT^SACM	●	●	○
AT+CAMM	●	●	○
AT+CAOC	●	●	○
AT+CCUG	●	●	○
AT+CCFC	●	○	○
AT+CCWA	●	○	○
AT+CHLD	●	○	○
AT+CLIP	●	○	○
AT+CLIR	●	○	○

AT Command	Normal Mode	✈	Charge
AT+COLP	●	○	○
AT+CPUC	●	●	○
AT+CSSN	●	○	○
AT+CUSD	●	○	○
Internet Service Commands			
AT^SICS	●	●	○
AT^SISS	●	●	○
AT^SISO	●	○	○
AT^SISC	●	○	○
AT^SISR	●	○	○
AT^SISW	●	○	○
GPRS Commands			
AT+CGACT	●	○	○
AT+CGANS	●	○	○
AT+CGATT	●	○	○
AT+CGAUTO	●	○	○
AT+CGDATA	●	○	○
AT+CGDCONT	●	●	○
AT+CGEQMIN	●	●	○
AT+CGEQREQ	●	●	○
AT+CGPADDR	●	●	○
AT+CGQMIN	●	●	○
AT+CGQREQ	●	●	○
AT+CGREG	●	●	○
AT+CGSMS	●	●	○
AT^SGACT	●	●	○
AT^SGAUTH	●	●	○
AT^SGCONF	●	●	○
ATA	●	○	○
ATD*99#	●	○	○
ATD*98#	●	○	○
ATH	●	○	○
ATS0	●	○	○
FAX Commands			
AT+FCLASS	●	●	○
AT+FRH	●	○	○
AT+FRM	●	○	○
AT+FRS	●	○	○
AT+FTH	●	○	○

AT Command	Normal Mode	✈	Charge
AT+FTM	●	○	○
AT+FTS	●	○	○
Short Message Service (SMS) Commands			
AT+CMGC	●	●	○
AT+CMGD	●	●	○
AT+CMGF	●	●	○
AT+CMGL	●	●	○
AT+CMGR	●	●	○
AT+CMGS	●	○	○
AT+CMGW	●	●	○
AT+CMSS	●	●	○
AT+CNMA	●	●	○
AT+CNMI	●	●	○
AT+CPMS	●	●	○
AT+CSCA	●	●	○
AT+CSCB	●	●	○
AT+CSDH	●	●	○
AT+CSMP	●	●	○
AT+CSMS	●	●	○
AT^SCML	●	●	○
AT^SCMR	●	●	○
AT^SCMS	●	●	○
AT^SCMW	●	●	○
AT^SLMS	●	●	○
AT^SMGL	●	●	○
AT^SMGO	●	●	○
AT^SMGR	●	●	○
AT^SSCONF	●	●	○
AT^SSDA	●	●	○
AT^SSMSS	●	●	○
SIM related Commands			
AT+CRSM	●	●	○
AT^SXSM	●	●	○
AT^SCKS	●	●	○
AT^SSET	●	●	○
AT^SCID	●	●	○
AT+CXXCID	●	●	○
Remote SIM Access (RSA) Commands			
AT^SRSA	●	●	○

AT Command	Normal Mode	→	Charge
AT^SRSM	●	●	○
SIM Application Toolkit (SAT) Commands			
AT^SSTA	●	◐	○
^SSTN	●	●	○
AT^SSTGI	●	◐	○
AT^SSTR	●	◐	○
Phonebook Commands			
AT+CPBR	●	●	○
AT+CPBS	●	●	○
AT+CPBW	●	●	○
AT^SDLD	●	●	○
AT^SPBC	●	●	○
AT^SPBD	●	●	○
AT^SPBG	●	●	○
AT^SPBS	●	●	○
Audio Commands			
ATL	●	●	○
ATM	●	●	○
AT+CLVL	●	●	○
AT+CMUT	●	●	○
AT+VTD	●	○	○
AT+VTS	●	○	○
AT^SAIC	●	●	○
AT^SNFA	●	●	○
AT^SNFD	●	●	○
AT^SNFI	●	●	○
AT^SNFM	●	●	○
AT^SNFO	●	●	○
AT^SNFPT	●	●	○
AT^SNFS	●	●	○
AT^SNFTTY	●	○	○
AT^SNFV	●	●	○
AT^SNFW	●	●	○
AT^SRTC	●	●	○
Hardware related Commands			
AT+CCLK	●	●	●
AT+CALA	●	●	●
AT^SBC	●	●	●
AT^SBV	●	●	○

AT Command	Normal Mode	→	Charge
AT^SCTM	●	●	●
AT^SSYNC	●	●	○
AT^SSPI	●	●	○
AT Commands for Handling Java Applications			
AT^SJRA	●	●	○
AT^SJNET	●	●	○
AT^SJOTAP	●	○	○
Miscellaneous Commands			
A/	●	●	○
ATS3	●	●	○
ATS4	●	●	○
ATS5	●	●	○
AT^SFDL	●	○	○

22.5 AT Command Settings storable with AT&W

Table 22.7: Settings Stored to User Profile on ASC0 / MUX Channel 1

AT Command	Stored Parameters
Configuration Commands	
ATQ	<n>
ATV	<value>
ATX	<value>
AT\V	<value>
AT+CMEE	<errMode>
Status Control Commands	
ATS18	<n>
Serial Interface Control Commands	
AT\Q	<n>
AT&C	<value>
AT&D	<value>
AT&S	<value>
ATE	<value>
AT+ICF	<format>, <parity>
AT+IFC	<TEflowcontrol>, <TAflowcontrol>
AT+ILRR	<value>
AT^STPB	<n>
Call related Commands	
ATS0	<n>
ATS6	<n>
ATS7	<n>
ATS8	<n>
ATS10	<n>
AT+CBST	<speed>, <name>, <ce>
AT+CRLP	<iws>, <mws>, <T1>, <N2>
AT^SLCC	<n>
AT+CR	<mode>
AT+CRC	<mode>
Network Service Commands	
AT+COPS	<format>
AT+CREG	<n>
Supplementary Service Commands	
AT^SACM	<n>

AT Command	Stored Parameters
AT+CLIP	<n>
GPRS Commands	
ATS0	<n>
FAX Commands	
AT+FCLASS	<n>
Short Message Service (SMS) Commands	
AT+CMGF	<mode>
AT+CNMI	<mode>, <mt>, <bm>, <ds>
AT+CSDH	<show>
AT+CSMS	<service>
AT^SMGO	<n>
SIM related Commands	
AT^SCKS	<mode>
AT^SSET	<n>
Miscellaneous Commands	
ATS3	<n>
ATS4	<n>
ATS5	<n>

Table 22.8: Settings Stored to User Profile on ASC1 / MUX Channels 2 and 3

AT Command	Stored Parameters
Configuration Commands	
ATQ	<n>
ATV	<value>
ATX	<value>
AT+CMEE	<errMode>
Serial Interface Control Commands	
AT\Q	<n>
AT&C	<value>
AT&D	<value>
AT&S	<value>
ATE	<value>
AT+ICF	<format>, <parity>
AT+IFC	<TEflowcontrol>, <TAflowcontrol>

AT Command	Stored Parameters
Call related Commands	
ATS0	<n>
AT^SLCC	<n>
AT+CR	<mode>
AT+CRC	<mode>
Network Service Commands	
AT+COPS	<format>
AT+CREG	<n>
Supplementary Service Commands	
AT^SACM	<n>
AT+CLIP	<n>
GPRS Commands	
ATS0	<n>
Short Message Service (SMS) Commands	
AT+CMGF	<mode>
AT+CNMI	<mode>, <mt>, <bm>, <ds>
AT+CSDH	<show>
AT+CSMS	<service>
AT^SMGO	<n>
SIM related Commands	
AT^SCKS	<mode>
AT^SSET	<n>
Miscellaneous Commands	
ATS3	<n>
ATS4	<n>
ATS5	<n>

22.6 Factory Default Settings Restorable with AT&F

Table 22.9: Factory Default Settings Restorable with AT&F

AT Command	Factory Defaults
Configuration Commands	
ATQ	<n>=0
ATV	<value>=1
ATX	<value>=4
AT\V	<value>=1
AT+CFUN	<fun>=1
AT+CMEE	<errMode>=0
AT+CSGS	<chset>="GSM"
AT^SM20	<CallMode>=1, <CmgwMode>=1
Status Control Commands	
AT+CMER	<mode>=0, <keyp>=0, <disp>=0, <ind>=0, <bfr>=0
AT+CIND	<mode>=1
ATS18	<n>=0
Serial Interface Control Commands	
AT\Q	<n>=0
AT&C	<value>=1
AT&D	<value>=2
AT&S	<value>=0
ATE	<value>=1
AT+ILRR	<value>=0
AT^STPB	<n>=0
Call related Commands	
ATS0	<n>=000
ATS6	<n>=000
ATS7	<n>=060
ATS8	<n>=0
ATS10	<n>=002
AT+CBST	<speed>=7, <name>=0, <ce>=1
AT+CRLP	<iws>=61, <mws>=61, <T1>=78, <N2>=6
AT^SLCC	<n>=0
AT+CR	<mode>=0
AT+CRC	<mode>=0
Network Service Commands	
AT+COPS	<format>=0
AT+CREG	<n>=0

AT Command	Factory Defaults
AT^SALS	<view>=0
Supplementary Service Commands	
AT^SACM	<n>=0
AT+CLIP	<n>=0
AT+CSSN	<n>=0, <m>=0
AT+CUSD	<n>=0
GPRS Commands	
AT+CGAUTO	<n>=3
AT+CGSMS	<service>=3
AT^SGAUTH	<auth>=3
ATS0	<n>=000
FAX Commands	
AT+FCLASS	<n>=0
Short Message Service (SMS) Commands	
AT+CMGF	<mode>=0
AT+CNMI	<mode>=0, <mt>=0, <bm>=0, <ds>=0, <bfr>=1
AT+CSDH	<show>=0
AT+CSMP	<fo>=17, <vp>=167, <dcs>=0, <pid>=0
AT+CSMS	<service>=0
AT^SMGO	<n>=0
AT^SSCONF	<ra>=0
AT^SSDA	<da>=0
AT^SSMSS	<seq>=0
SIM related Commands	
AT^SCKS	<mode>=0
AT^SSET	<n>=0
Phonebook Commands	
AT+CPBS	<storage>="SM"
AT^SPBS	<internal-counter>=0
Audio Commands	
AT+VTD	<duration>=1
Hardware related Commands	
AT^SCTM	<n>=0
Miscellaneous Commands	
ATS3	<n>=013

AT Command	Factory Defaults
ATS4	<n>=010
ATS5	<n>=008

22.7 Summary of Unsolicited Result Codes (URC)

Table 22.10: Summary of Unsolicited Result Codes (URC)

AT Command	URC
Configuration Commands	
AT+CFUN	^SYSSTART
AT+CFUN	^SYSSTART CHARGE-ONLY MODE
AT^SMSO	^SHUTDOWN
AT^SCFG	^SCFG: "AutoExec", <AutoExecState>, <AutoExecType>, <AutoExecIndex>, <AutoExecMode>, <AutoExecATC>
AT^SCFG	^SYSSTART AIRPLANE MODE
Status Control Commands	
AT+CMER	+CIEV: <indDescr>, <indValue> ₁ [, <indValue> ₂][, <indValue>[,...]]
AT^SIND	+CIEV: <indDescr>, <indValue>
AT^SIND	+CIEV: <indDescr>, <adnEntry>, <adnNumber>, <adnType>, <adnText> +CIEV: <indDescr>, "READY"
AT^SIND	+CIEV: <indDescr>, <indValue>, <vmCounter>
AT^SIND	+CIEV: <indDescr>, <indValue>, <eonsOperator>, <servProvider>
AT^SIND	+CIEV: <indDescr>, <nitzUT>, <nitzTZ>, <nitzDST>
Call related Commands	
AT^SLCC	if the list of current calls is empty: ^SLCC: if one or more calls are currently in the list: ^SLCC: <idx>, <dir>, <stat>, <mode>, <empty>, <traffic channel assigned>[, <number>, <type>[, <alpha>]] [^SLCC: <idx>, <dir>, <stat>, <mode>, <empty>, <traffic channel assigned>[, <number>, <type>[, <alpha>]] [...] ^SLCC:
AT+CRIC	+CRING: <type>
Network Service Commands	
AT+CREG	+CREG: <stat>
AT+CREG	+CREG: <stat>[, <lac>, <ci>]
AT^SALS	^SALS: <line>
Supplementary Service Commands	
AT^SACM	+CCCM: <ccm>
AT+CCWA	+CCWA: <calling number>, <type of number>, <class>, , <CLI validity>
AT+CCWA	^SCWA
AT+CLIP	+CLIP: <number>, <type>, , [, <alpha>][, <CLI validity>]
AT+CLIP	+CLIP: <number>, <type>
AT+COLP	+COLP: <number>, <type>
AT+CSSN	+CSSI: <code 1>

AT Command	URC
AT+CSSN	+CSSU: <code 2>
AT+CUSD	+CUSD: <m>[<str>[<dcs>]]
Internet Service Commands	
AT^SISO	^SIS: <srvProfileId>, <urcCause>[, [<urcInfoId>][, <urcInfoText>]]
AT^SISR	^SISR: <srvProfileId>, <urcCauseId>
AT^SISW	^SISW: <srvProfileId>, <urcCauseId>
GPRS Commands	
AT+CGREG	+CGREG: <stat>
AT+CGREG	+CGREG: <stat>, <lac>, <ci>
Short Message Service (SMS) Commands	
AT+CNMI	+CMTI: <mem3>, <index>
AT+CNMI	+CMT: <length><CR><LF><pdu>
AT+CNMI	+CMT: <oa>, <scts>[, <tooa>, <fo>, <pid>, <dcs>, <sca>, <tosca>, <length>]<CR><LF><data>
AT+CNMI	+CBM: <length><CR><LF><pdu>
AT+CNMI	+CBM: <sn>, <mid>, <dcs>, <page>, <pages><CR><LF><data>
AT+CNMI	+CDS: <length><CR><LF><pdu>
AT+CNMI	+CDS: <fo>, <mr>[, <ra>][, <tora>], <scts>, <dt>, <st>
AT+CNMI	+CDSI: <mem3>, <index>
AT^SMGO	^SMGO: <mode>
SIM related Commands	
AT^SCKS	^SCKS: <SimStatus>
AT^SSET	^SSIM READY
Remote SIM Access (RSA) Commands	
AT^SRSA	^SRSA: <devId>, <sapRole>, <connState>
AT^SRSM	^SRSM: <RsaDevId>, <RsaMsgId>[, <RsaMsgData>[, <RsaMsgLen>[, <RsaMsgRc>]]]
SIM Application Toolkit (SAT) Commands	
^SSTN	^SSTN: <cmdType>
^SSTN	^SSTN: <cmdTerminateValue>
^SSTN	^SSTN: 254
^SSTN	^SSTN: 255
Hardware related Commands	
AT+CALA	+CALA: [<text>]
AT^SBC	^SBC: Undervoltage
AT^SBC	^SBC: Overvoltage warning
AT^SBC	^SBC: Overvoltage shutdown

AT Command	URC
AT^SCTM	^SCTM_A: <m>
AT^SCTM	^SCTM_B: <m>

22.8 Alphabetical List of AT Commands

Table 22.11: Alphabetical List of AT Commands

AT Command	Description	Section and Page
+++	Switch from data mode to command mode	Section 7.18, page 156
^SSTN	SAT Notification	Section 16.2, page 367
A/	Repeat previous command line	Section 21.1, page 442
AT&C	Set circuit Data Carrier Detect (DCD) function mode	Section 4.2, page 91
AT&D	Set circuit Data Terminal Ready (DTR) function mode	Section 4.3, page 92
AT&F	Set all current parameters to manufacturer defaults	Section 2.1, page 29
AT&S	Set circuit Data Set Ready (DSR) function mode	Section 4.4, page 93
AT&V	Display current configuration	Section 2.2, page 30
AT&W	Stores current configuration to user defined profile	Section 2.3, page 33
AT+CACM	Accumulated call meter (ACM) reset or query	Section 9.1, page 200
AT+CALA	Set alarm time	Section 19.2, page 415
AT+CAMM	Accumulated call meter maximum (ACMmax) set or query	Section 9.3, page 203
AT+CAOC	Advice of Charge information	Section 9.4, page 204
AT+CBST	Select bearer service type	Section 7.19, page 157
AT+CCFC	Call forwarding number and conditions control	Section 9.6, page 207
AT+CCLK	Real Time Clock	Section 19.1, page 414
AT+CCUG	Closed User Group	Section 9.5, page 205
AT+CCWA	Call Waiting	Section 9.7, page 211
AT+CEER	Extended Error Report	Section 3.4, page 79
AT+CFUN	Set phone functionality	Section 2.9, page 39
AT+CGACT	PDP context activate or deactivate	Section 11.1, page 247
AT+CGANS	Manual response to a network request for PDP context activation	Section 11.2, page 249
AT+CGATT	GPRS attach or detach	Section 11.3, page 251
AT+CGAUTO	Automatic response to a network request for PDP context activation	Section 11.4, page 252
AT+CGDATA	Enter data state	Section 11.5, page 254
AT+CGDCONT	Define PDP Context	Section 11.6, page 256
AT+CGEQMIN	3G Quality of Service Profile (Minimum acceptable)	Section 11.7, page 258
AT+CGEQREQ	3G Quality of Service Profile (Requested)	Section 11.8, page 262
AT+CGMI	Request manufacturer identification	Section 6.2, page 131
AT+CGMM	Request model identification	Section 6.4, page 132
AT+CGMR	Request revision identification of software status	Section 6.6, page 133
AT+CGPADDR	Show PDP address	Section 11.9, page 266
AT+CGQMIN	Quality of Service Profile (Minimum acceptable)	Section 11.10, page 267
AT+CGQREQ	Quality of Service Profile (Requested)	Section 11.11, page 271
AT+CGREG	GPRS network registration status	Section 11.12, page 275
AT+CGSMS	Select service for MO SMS messages	Section 11.13, page 277
AT+CGSN	Request International Mobile Equipment Identity (IMEI)	Section 6.8, page 134

AT Command	Description	Section and Page
AT+CHLD	Call Hold and Multiparty	Section 9.8, page 215
AT+CHUP	Hang up call	Section 7.10, page 147
AT+CIMI	Request International Mobile Subscriber Identity (IMSI)	Section 6.10, page 135
AT+CIND	Indicator control	Section 3.2, page 69
AT+CLCC	List current calls of ME	Section 7.21, page 159
AT+CLCK	Facility lock	Section 5.4, page 119
AT+CLIP	Calling line identification presentation	Section 9.9, page 217
AT+CLIR	Calling line identification restriction	Section 9.10, page 219
AT+CLVL	Loudspeaker volume level	Section 18.4, page 391
AT+CMEE	Mobile Equipment Error Message Format	Section 2.12, page 45
AT+CMER	Mobile Equipment Event Reporting	Section 3.1, page 67
AT+CMGC	Send an SMS command	Section 13.2, page 303
AT+CMGD	Delete SMS message	Section 13.3, page 304
AT+CMGF	Select SMS message format	Section 13.4, page 305
AT+CMGL	List SMS messages from preferred store	Section 13.5, page 306
AT+CMGR	Read SMS messages	Section 13.6, page 308
AT+CMGS	Send SMS message	Section 13.7, page 310
AT+CMGW	Write SMS messages to memory	Section 13.8, page 312
AT+CMSS	Send SMS messages from storage	Section 13.9, page 314
AT+CMUT	Mute control	Section 18.5, page 392
AT+CMUX	Enter multiplex mode	Section 4.10, page 104
AT+CNMA	New SMS message acknowledge to ME/TE, only phase 2+	Section 13.10, page 315
AT+CNMI	New SMS message indications	Section 13.11, page 316
AT+COLP	Connected Line Identification Presentation	Section 9.11, page 220
AT+COPN	Read operator names	Section 8.1, page 174
AT+COPS	Operator Selection	Section 8.2, page 175
AT+CPAS	Mobile equipment activity status	Section 3.6, page 88
AT+CPBR	Read from Phonebook	Section 17.2, page 371
AT+CPBS	Select phonebook memory storage	Section 17.3, page 374
AT+CPBW	Write into Phonebook	Section 17.4, page 376
AT+CPIN	PIN Authentication	Section 5.1, page 109
AT+CPIN2	PIN2 Authentication	Section 5.2, page 113
AT+CPMS	Preferred SMS message storage	Section 13.12, page 319
AT+CPUC	Price per unit and currency table	Section 9.12, page 222
AT+CPWD	Change Password	Section 5.6, page 125
AT+CR	Service reporting control	Section 7.23, page 167
AT+CRC	Set Cellular Result Codes for incoming call indication	Section 7.24, page 168
AT+CREG	Network registration	Section 8.4, page 180
AT+CRLP	Select radio link protocol parameters for originated non-transparent data calls	Section 7.20, page 158
AT+CRSM	Restricted SIM Access	Section 14.1, page 342

AT Command	Description	Section and Page
AT+CSCA	SMS service centre address	Section 13.13 , page 321
AT+CSCB	Select Cell Broadcast Message Indication	Section 13.14 , page 322
AT+CSCS	Select TE character set	Section 2.13 , page 50
AT+CSDH	Show SMS text mode parameters	Section 13.15 , page 323
AT+CSMP	Set SMS text mode parameters	Section 13.16 , page 324
AT+CSMS	Select Message Service	Section 13.17 , page 326
AT+CSNS	Single Numbering Scheme	Section 7.25 , page 169
AT+CSQ	Signal quality	Section 8.5 , page 183
AT+CSSN	Supplementary service notifications	Section 9.13 , page 224
AT+CUSD	Supplementary service notifications	Section 9.14 , page 226
AT+CXXCID	Display card ID	Section 14.6 , page 351
AT+FCLASS	Fax: Select, read or test service class	Section 12.2 , page 291
AT+FRH	Receive Data Using HDLC Framing	Section 12.3 , page 292
AT+FRM	Receive Data	Section 12.4 , page 293
AT+FRS	Receive Silence	Section 12.5 , page 294
AT+FTH	Transmit Data Using HDLC Framing	Section 12.6 , page 295
AT+FTM	Transmit Data	Section 12.7 , page 296
AT+FTS	Stop Transmission and Wait	Section 12.8 , page 297
AT+GCAP	Request complete TA capabilities list	Section 2.11 , page 44
AT+GMI	Request manufacturer identification	Section 6.3 , page 131
AT+GMM	Request model identification	Section 6.5 , page 132
AT+GMR	Request revision identification of software status	Section 6.7 , page 133
AT+GSN	Request International Mobile Equipment Identity (IMEI)	Section 6.9 , page 134
AT+ICF	Serial Interface Character Framing	Section 4.6 , page 95
AT+IFC	Set Flow Control separately for data directions	Section 4.7 , page 97
AT+ILRR	Set TE-TA local rate reporting	Section 4.8 , page 99
AT+IPR	Set fixed local rate	Section 4.9 , page 101
AT+VTD	Tone duration	Section 18.6 , page 393
AT+VTS	DTMF and tone generation	Section 18.7 , page 394
AT+WS46	Select wireless network	Section 3.7 , page 89
AT\Q	Flow control	Section 4.1 , page 90
AT\V	Set CONNECT result code format	Section 2.7 , page 37
AT^MONI	Monitor idle mode and dedicated mode	Section 8.7 , page 186
AT^MONP	Monitor neighbour cells	Section 8.8 , page 189
AT^SACM	Advice of charge and query of ACM and ACMmax	Section 9.2 , page 201
AT^SAIC	Audio Interface Configuration	Section 18.8 , page 395
AT^SALS	Alternate Line Service	Section 8.10 , page 193
AT^SBC	Battery Charge Control	Section 19.3 , page 418
AT^SBV	Battery/Supply Voltage	Section 19.4 , page 421
AT^SCFG	Extended Configuration Settings	Section 2.14 , page 51
AT^SCID	Display SIM card identification number	Section 14.5 , page 350
AT^SCKS	Query SIM and Chip Card Holder Status	Section 14.3 , page 347

AT Command	Description	Section and Page
AT^SCML	List Concatenated SMS messages from preferred store	Section 13.18 , page 328
AT^SCMR	Read concatenated SMS messages	Section 13.19 , page 330
AT^SCMS	Send concatenated SMS messages	Section 13.20 , page 332
AT^SCMW	Write concatenated SMS messages to memory	Section 13.21 , page 333
AT^SCNI	List Call Number Information	Section 7.26 , page 170
AT^SCTM	Set critical operating temperature presentation mode or query temperature	Section 19.5 , page 422
AT^SDLD	Delete the 'last number redial' memory	Section 17.5 , page 379
AT^SFDL	Enter Firmware Download Mode	Section 21.5 , page 446
AT^SGACT	Query all PDP context activations	Section 11.14 , page 278
AT^SGAUTH	Set type of authentication for PPP connection	Section 11.15 , page 280
AT^SGCONF	Configuration of GPRS related Parameters	Section 11.16 , page 281
AT^SHOM	Display Homezone	Section 8.11 , page 195
AT^SHUP	Hang up call(s) indicating a specific GSM04.08 release cause	Section 7.11 , page 148
AT^SICS	Internet Connection Setup Profile	Section 10.1 , page 229
AT^SIND	Extended Indicator Control	Section 3.3 , page 72
AT^SISC	Internet Service Close	Section 10.4 , page 242
AT^SISO	Internet Service Open	Section 10.3 , page 240
AT^SISR	Internet Service Read Data	Section 10.5 , page 243
AT^SISS	Internet Service Setup Profile	Section 10.2 , page 233
AT^SISW	Internet Service Write Data	Section 10.6 , page 245
AT^SJNET	Set Dialup Network Access Parameters	Section 20.2 , page 438
AT^SJOTAP	Over The Air Application Provisioning	Section 20.3 , page 440
AT^SJRA	Run Java Application	Section 20.1 , page 437
AT^SLCC	Siemens defined command to list current calls of ME	Section 7.22 , page 161
AT^SLCD	Display Last Call Duration	Section 7.27 , page 171
AT^SLCK	Facility lock	Section 5.5 , page 124
AT^SLMS	List SMS Memory Storage	Section 13.22 , page 334
AT^SM20	Set M20 compatibility mode	Section 2.15 , page 66
AT^SMGL	List SMS messages from preferred store without setting status to REC READ	Section 13.23 , page 335
AT^SMGO	Set or query SMS overflow presentation mode or query SMS overflow	Section 13.24 , page 336
AT^SMGR	Read SMS message without setting status to REC READ	Section 13.25 , page 338
AT^SMONC	Cell Monitoring	Section 8.6 , page 184
AT^SMONG	GPRS Monitor	Section 8.9 , page 191
AT^SMSO	Switch off mobile station	Section 2.10 , page 43
AT^SNFA	Set or query of microphone attenuation	Section 18.9 , page 397
AT^SNFD	Set audio parameters to manufacturer default values	Section 18.10 , page 399
AT^SNFI	Set microphone path parameters	Section 18.11 , page 400
AT^SNFM	Set microphone audio path and power supply	Section 18.12 , page 401
AT^SNFO	Set audio output (= loudspeaker path) parameter	Section 18.13 , page 403

AT Command	Description	Section and Page
AT^SNFPT	Set progress tones	Section 18.14 , page 405
AT^SNFS	Select audio hardware set	Section 18.15 , page 406
AT^SNFTTY	Signal TTY/CTM audio mode capability	Section 18.16 , page 409
AT^SNFV	Set loudspeaker volume	Section 18.17 , page 410
AT^SNFW	Write audio setting in non-volatile store	Section 18.18 , page 411
AT^SOPS	Extended Operator Selection	Section 8.3 , page 178
AT^SPBC	Find first matching entry in sorted phonebook	Section 17.6 , page 380
AT^SPBD	Purge phonebook memory storage	Section 17.7 , page 381
AT^SPBG	Display phonebook entries in alphabetical order	Section 17.8 , page 382
AT^SPBS	Step through the selected phonebook alphabetically	Section 17.9 , page 385
AT^SPIC	Display PIN counter	Section 5.3 , page 115
AT^SPLM	Read the PLMN list	Section 8.12 , page 196
AT^SPLR	Read entry from the preferred operators list	Section 8.13 , page 198
AT^SPLW	Write an entry to the preferred operators list	Section 8.14 , page 199
AT^SPWD	Change Password	Section 5.7 , page 129
AT^SRSA	Remote SIM Access Activation	Section 15.1 , page 354
AT^SRSM	Remote SIM Access Message	Section 15.2 , page 359
AT^SRTC	Ring tone configuration	Section 18.19 , page 412
AT^SSCONF	SMS Command Configuration	Section 13.26 , page 339
AT^SSDA	Set SMS Display Availability	Section 13.27 , page 340
AT^SSET	Indicate SIM data ready	Section 14.4 , page 349
AT^SSMSS	Set Short Message Storage Sequence	Section 13.28 , page 341
AT^SSPI	Serial Protocol Interface	Section 19.7 , page 428
AT^SSTA	SAT Interface Activation	Section 16.1 , page 365
AT^SSTGI	SAT Get Information	Section 16.3 , page 368
AT^SSTR	SAT Response	Section 16.4 , page 369
AT^SSYNC	Configure SYNC Pin	Section 19.6 , page 425
AT^STCD	Display Total Call Duration	Section 7.28 , page 172
AT^STPB	Transmit Parity Bit (for 7E1 and 7O1 only)	Section 4.11 , page 108
AT^SXSM	Extended SIM Access	Section 14.2 , page 345
ATA	Answer a call	Section 7.2 , page 137
ATA	Manual response to a network request for PDP context activation	Section 11.17 , page 282
ATD	Mobile originated call to specified number	Section 7.3 , page 138
ATD*98#	Request GPRS IP service	Section 11.19 , page 284
ATD*99#	Request GPRS service	Section 11.18 , page 283
ATD<mem><n>	Mobile originated call using specific memory and index number	Section 7.4 , page 140
ATD<n>	Mobile originated call from active memory using index number	Section 7.5 , page 142
ATD<str>	Mobile originated call from active memory using corresponding field	Section 7.6 , page 143
ATDI	Mobile originated call to ISDN number	Section 7.7 , page 144

AT Command	Description	Section and Page
ATDL	Redial last number used	Section 7.8 , page 145
ATE	Enable command echo	Section 4.5 , page 94
ATH	Disconnect existing connection	Section 7.9 , page 146
ATH	Manual rejection of a network request for PDP context activation	Section 11.20 , page 285
ATI	Display product identification information	Section 6.1 , page 130
ATL	Set monitor speaker loudness	Section 18.2 , page 390
ATM	Set monitor speaker mode	Section 18.3 , page 390
ATO	Switch from command mode to data mode / PPP online mode	Section 7.17 , page 155
ATP	Select pulse dialing	Section 7.29 , page 173
ATQ	Set result code presentation mode	Section 2.4 , page 34
ATS0	Set number of rings before automatically answering a call	Section 7.12 , page 150
ATS0	Automatic response to a network request for PDP context activation	Section 11.21 , page 286
ATS10	Set disconnect delay after indicating the absence of data carrier	Section 7.16 , page 154
ATS18	Extended call release report	Section 3.5 , page 86
ATS3	Set command line termination character	Section 21.2 , page 443
ATS4	Set response formatting character	Section 21.3 , page 444
ATS5	Write command line editing character	Section 21.4 , page 445
ATS6	Set pause before blind dialing	Section 7.13 , page 151
ATS7	Set number of seconds to wait for connection completion	Section 7.14 , page 152
ATS8	Set number of seconds to wait for comma dialing modifier	Section 7.15 , page 153
ATT	Select tone dialing	Section 7.30 , page 173
ATV	Set result code format mode	Section 2.5 , page 35
ATX	Set CONNECT result code format and call monitoring	Section 2.6 , page 36
ATZ	Set all current parameters to user defined profile	Section 2.8 , page 38